



# ESPRIT-G FIRE CONTROL EXTINGUISHING PANEL INSTALLATION, COMMISSIONING & OPERATING MANUAL

This manual covers the installation, programming and commissioning of the **Esprit Extinguishing Fire Alarm Control Panels** for **One and Two Flood Zones**.

# INTRODUCTION



**Haes Technologies Ltd, Unit 3, Horton Industrial Park, West Drayton, Uxbridge, UB7 8JD**

**Model Number**

ESG 1002/1003/1004

**CPR Number**

2797-CPR-720738

**European Standard EN54-2 : 1997 + A1 : 2006**

Control and indicating equipment for fire detection and fire alarm systems for buildings.

Provided Options (with requirements):

Output to fire alarm devices, dependency type 'A', test condition

**European Standard EN54-4 : 1998**

Power supply equipment for fire detection and fire alarm systems for buildings.

**European Standard EN12094-1 : 2003**

Requirements and test methods for electrical automatic control and delay devices

Haes Technologies Ltd declare that the products identified below conform to the essential requirements specified in the Construction Products Regulation CPR305/2011/EU.

**In addition, the product complies with the following:**

Low Voltage Directive 2014/35/EC,

EN60950-1: 2006 Safety of information technology equipment,

Electromagnetic Compatibility Directive 2014/30/EC,

EN61000-6-3:2007 + A1:2011 Emissions, Class B,

EN50130-4: 2011 +A1:2014 Immunity, Product Family Standard.

This product has been designed to comply with the requirement of the low voltage safety and the EMC directives. Failure to follow the instructions may compromise its adherence to this standard.

**List of optional functions with requirements:****EN 12094-1: 2003**

- Electrical automatic control and delay device.
- Environmental class: A
- 1 Flooding Zone
- CO2 Low Pressure
- CO2 High Pressure
- Inert gas systems

**Provided options:**

- 4.17 Delay of extinguishing signal
- 4.18 Monitor Flow of Extinguishing Agent
- 4.19 Monitoring of status of components
- 4.20 Emergency Hold Device
- 4.21 Control of flooding time: (60 – 1800) seconds
- 4.23 Manual Only Mode
- 4.26 Triggering Signals to Equipment outside the System
- 4.27 Emergency Abort Device
- 4.30 Activation of Alarm Devices with Different Signals

**EN54-2: 1997 + A1**

- Control and indicating equipment for fire detection and fire alarm systems for buildings

**Provided options:**

- 7.8 Outputs to Fire Alarm Devices
- 7.9 Fire alarm routing
- 7.11 Delays to outputs
- 7.13 Alarm Counter
- 8.9 Fault warning routing equipment
- 10 Test Condition

**EN54-4: 1998**

- Power supply equipment for fire detection and fire alarm systems for buildings. Non-standard

**Provided Options:**

- Manual Extraction Control
- Charge during alarm
- Earth fault monitoring
- UPS Mode
- Changeable password for Level 2
- Adjustable Date & Time

**Panels Model No.**

Model No	Model Name	Standby Current	Alarm Current
ESG-1002	Esprit Ext Control Panel, Single Flood Zone, 3.4A PSU	205mA	300mA
ESG-1003	Esprit Ext Control Panel, Dual Flood Zone, 3.4A PSU, Large Cabinet	207mA	365mA
ESG-1004	Esprit Ext Control Panel, Single Flood Zone, 3.4A PSU, Large Cabinet	205mA	300mA

# Contents

INTRODUCTION..... 2

PRODUCT OVERVIEW ..... 7

    General Description of the Equipment ..... 7

        Cabinet for Single Flood Zone ..... 8

        Cabinet for Two Flood Zones ..... 8

        Circuit Boards ..... 9

        Circuit Description/Function ..... 11

Technical Specification ..... 13

INSTALLATION CONSIDERATION ..... 17

    Safety..... 17

        Warnings..... 17

        Cautions ..... 17

        ESD Precaution ..... 18

    Installing the System ..... 18

        Environment..... 18

        Mounting the Cabinet..... 18

        Mains Connections ..... 19

        Connecting the Batteries ..... 19

        Battery Charging Voltage Checks..... 20

        Detection Zone Inputs..... 20

        Sounders / Monitored Output Circuits..... 22

        Relay Outputs ..... 23

        Inputs - Class Change and Pulse ..... 24

        Monitored Input Wiring..... 25

        Extinguishing Actuator Output Wiring ..... 25

        Igniting Actuators ..... 25

        Solenoid Actuators..... 26

        Remote Status Unit (RSU) Wiring ..... 27

OPERATING INSTRUCTIONS ..... 28

    Panel Control and Indicators ..... 28

        Control Panel ..... 28

    User Controls..... 32

        General User Controls ..... 32

        Authorized User Controls..... 33

        Engineer Controls ..... 34

    Panel Alarm Conditions ..... 36

        Fire Alarm Condition ..... 36

        Activated/Released Condition..... 36

        Hold Condition ..... 39

        Abort Condition ..... 39

Fault Condition ..... 39

CONFIGURING THE SYSTEM..... 41

    Accessing the Menu Structure..... 41

    Learn System ..... 42

    Set Common Output for HOLD & ABORT ..... 44

    User Menu ..... 46

        User Menu: AUTO/MANUAL MODE Menu ..... 46

        User Menu: DISABLE ..... 47

        User Menu: Time & Date ..... 48

        User Menu: LAMP TEST ..... 49

        User Menu: Contrast..... 49

        User Menu: BUZZER ..... 50

        User Menu/sub-menu Breakdown ..... 51

    CONFIG Menu..... 53

        CONFIG Menu: PANEL ..... 54

        CONFIG Menu: GAS CARD ..... 57

        CONFIG Menu: DEVICES ..... 58

        CONFIG Menu: P-BUS ..... 61

        CONFIG Menu: PSU..... 61

        CONFIG Menu/sub-menu Breakdown..... 62

    CONTROL Menu ..... 68

        Control Menu: EXTRACT ..... 68

        Control Menu: FLOODING ..... 69

        Control Menu: DELAYS ..... 69

        CONTROL Menu/sub-menu Breakdown ..... 70

    Report Menu ..... 71

        Report Menu: ALARM..... 71

        Report Menu: FAULT ..... 72

        Report Menu: DISABLE ..... 73

        Report Menu: OTHER..... 74

        Report Menu: HISTORY ..... 75

        Report Menu: Versions ..... 76

        Report Menu: COUNTER ..... 76

        Report Menu: Gas Card..... 77

        Report Menu: PSU Card..... 77

        Report Menu: BATTERY..... 77

        Report Menu/sub-menu Breakdown ..... 79

    ENG Menu ..... 83

        ENG Menu: TEST ..... 83

        ENG Menu: MISC ..... 85

        ENG Menu/sub-menu Breakdown ..... 86

SERVICE & MAINTENANCE..... 87

## PRODUCT OVERVIEW

### General Description of the Equipment

The ESPRiT-G extinguishing gas panel acts as both a conventional fire alarm panel and an automatic extinguisher control panel and was designed from the ground up to be intuitive and flexible for the engineer. The panel is easy to install and programme and incorporates a large 240 x 64-pixel graphical LCD display, with an easy-to-navigate menu system, which contains simple discernible icons in each section.

In-built safety features ensure the client's employees and assets are protected to the highest degree with the minimum risk.

The panels are available in One Flood Zone (three Conventional Detection Circuits), and Two Flood Zones (six conventional detection circuits), and hence will be presented in two different enclosure sizes.

The Gas panel can be powered by either; 35W, 1.2 Amps (for 1 Flooding Area), or 100W, 3.4 Amps (for 2 Flooding Areas), switch mode PSU's, rated at 230VAC, 50/60Hz.

The panel also offers optional Output Expansion Relay Board providing additional volt-free relay outputs.

The panel supports connections for up to Sixteen Remote Status Units (RSU), or up to Sixteen Economy Remote Status Units (EcoRSU).

This product has been designed and manufactured in the United Kingdom.

### Cabinet for Single Flood Zone

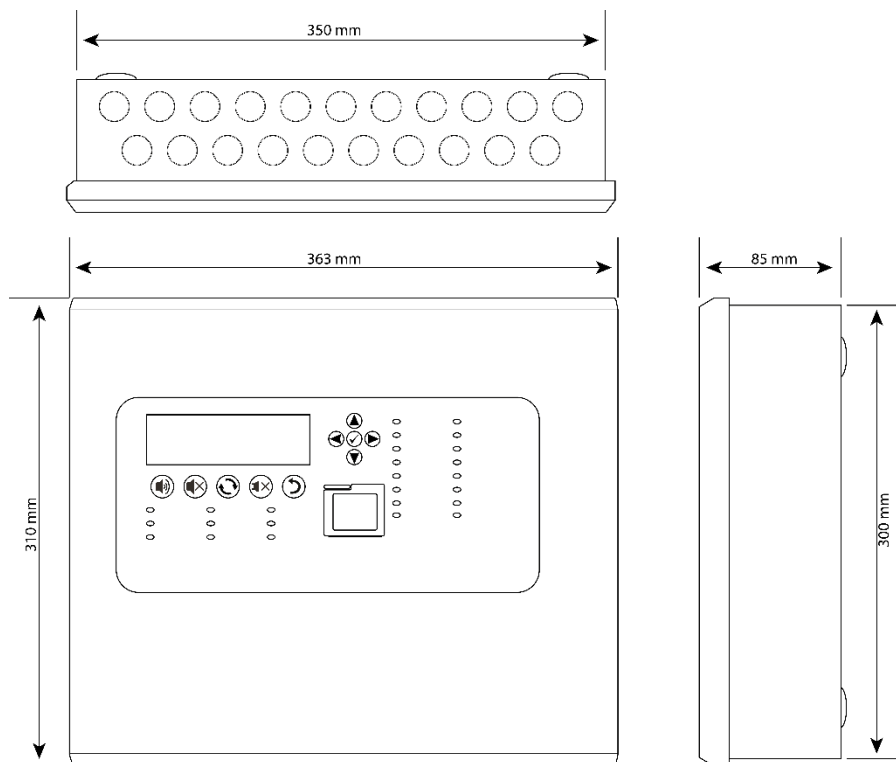

### Cabinet for Two Flood Zones

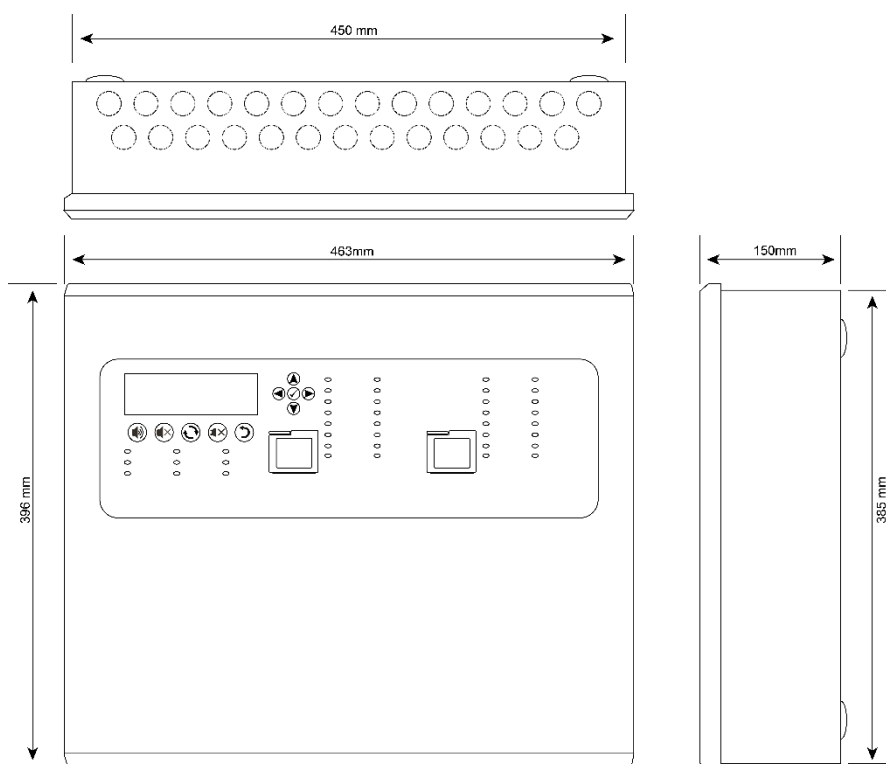



### Circuit Boards

#### 2827-206 DISPLAY CARD & 2972-206 EXTENSION LEDs CARD (2nd Flood Zone)

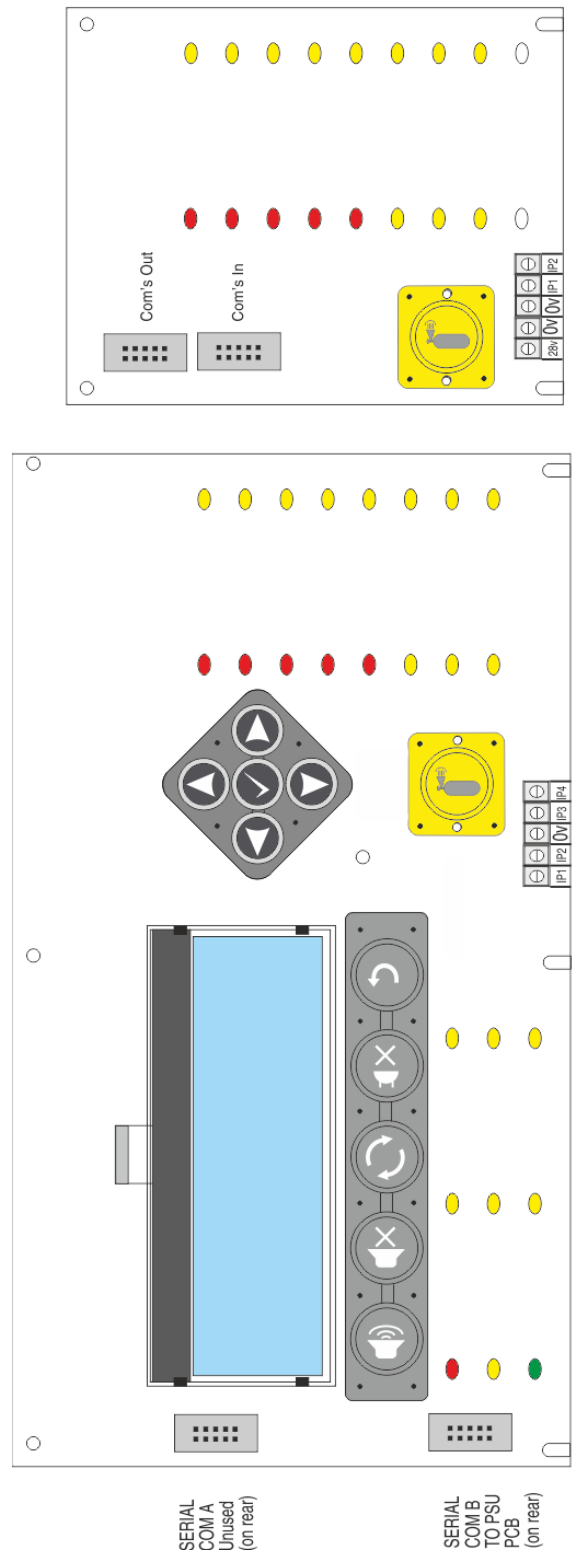

2879-206 PSU CARD & 2883-206 GAS CARD

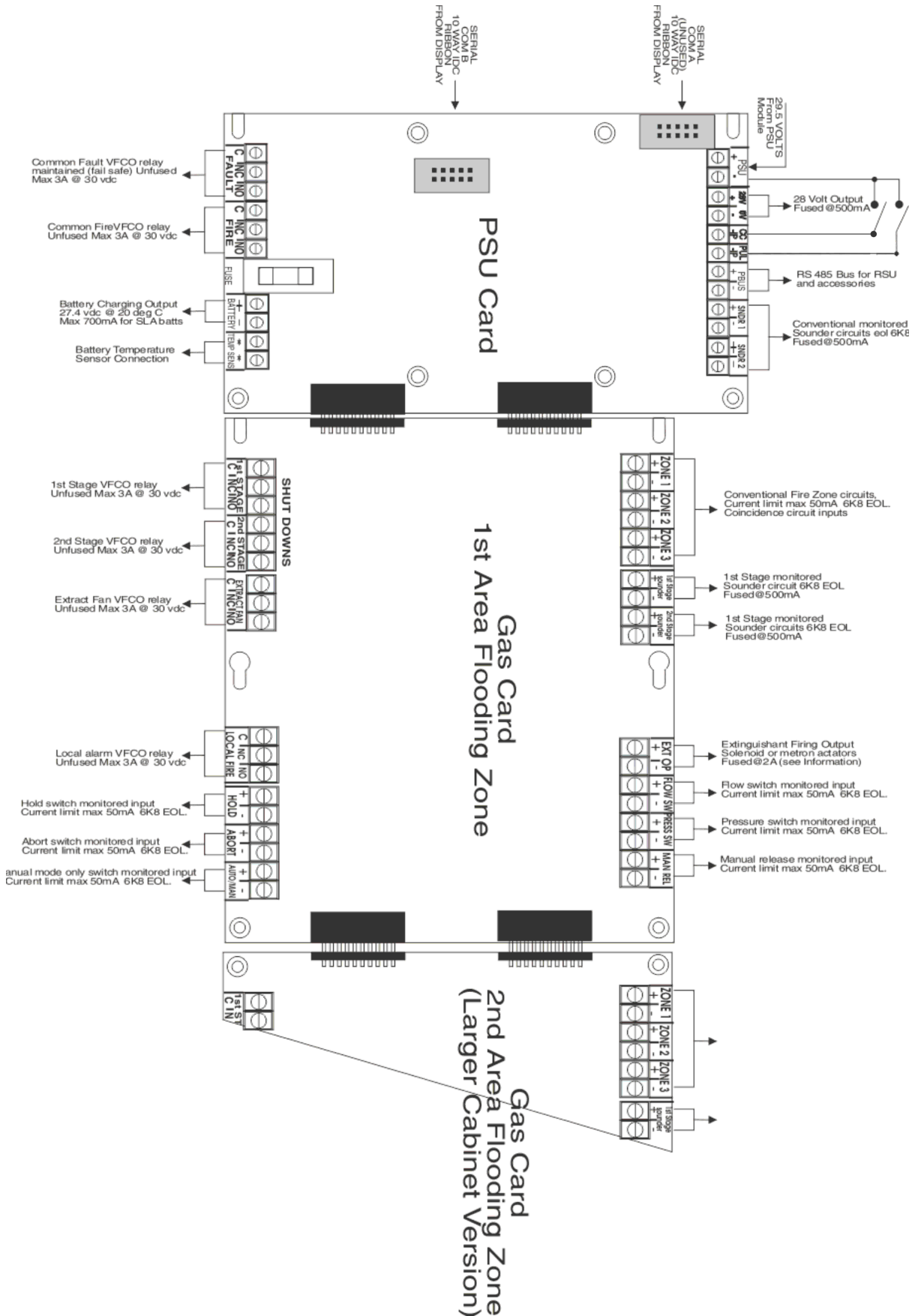

## Circuit Description/Function

### TPC2827-206 DISPLAY CARD

#### IP1/IP2/0V

Monitored inputs for **Activate Controls** (IP1/0V) and **Select Mode** (IP2/0V) key switches.

#### IP3/IP4

Not used.

### TPC2972-206 EXTENSION LEDs CARD (2<sup>nd</sup> Flood Zone)

#### 28V/0V

28V input.

#### 0V/IP1

Monitored input from Flood Zone 2 **Select Mode** key switch.

#### IP2

Not used.

### TPC2879-206 PSU PCB

#### PSU (+ -)

Monitored 29.5VDC input from power supply module.

#### 28V/0V (+ -)

28V output, fused at 500mA.

#### CC (-IP)

Class Change switch (–ve) inputs, which cause the common sounder outputs to operate.

**Note:** Stage sounders will not be affected unless programmed to do so (see program details).

#### PUL (-IP)

Pulse switch (–ve) inputs, which cause the common sounder and loop sounders outputs to pulse. PBUS (+ -)

**Note:** Stage sounders will not be affected unless programmed to do so (see program details).

#### PBUS

Input for RS-485 Peripheral BUS (PBUS) circuit, for remote control call points. The PBUS circuit is not intended for repeaters or networking.

#### SNDR 1 (+ -)/SNDR 2 (+ -)

Two 24VDC programmable and monitored sounder outputs, configurable as FARE and FFRE (Fire and Fault routing).

- They can be programmed to turn OFF or ON in Continuously mode or in Pulsing mode (1s ON and 1s OFF).
- The sounders can be configured to be non-silencing or silencing.

#### FAULT (C NC NO)

Common fault signal changeover relay contacts. Normally energised (failsafe) contacts, change over when any fault is active on the panel or in the event of total power loss. Unfused, Max 3A at 30VDC.

#### FIRE (C NC NO)

Common alarm changeover relay contacts. Activate when an alarm condition (470R) exists on the input or ZONE circuit. Unfused, Max 3A at 30VDC.

**BATTERY (+ -)**

Connections for two VRLA batteries (up to 18Ahr, depending on cabinet size) charging output (temperature compensated). 27.4VDC output at 20°C, Max. 700mA.

**TEMP SENS (\* \*)**

Connections for battery temperature sensor.

**TPC2883-206 Gas Card****ZONE 1 (+ -)/ZONE 2 (+ -)/ZONE 3 (+ -)**

Conventional fire zone circuits, coincidence circuit inputs. Current limit Max. 50mA (6K8 End-of-Line (EOL) resistor).

**1st Stage Sounder (+ -)/2nd Stage Sounder (+ -)**

Monitored sounder circuit (6K8 EOL), fused at 500mA.

**EXT OP (+ -)**

Extinguishant firing output (Solenoid or metron actuators). Fused at 2A

**FLOW SW (+ -)**

Flow switch monitored input. Current limit Max. 50mA (6K8 EOL).

**PRESS SW (+ -)**

Pressure switch monitored input. Current limit Max. 50mA (6K8 EOL).

**MAN REL (+ -)**

Manual release monitored input. Current limit Max. 50mA (6K8 EOL).

**SHUT DOWNS – 1st STAGE (C NC NO)/2nd STAGE (C NC NO)**

1<sup>st</sup> and 2<sup>nd</sup> stage common fault signal changeover relay contacts. Unfused, Max 3A at 30VDC.

**EXTRACT FAN (C NC NO)**

Extract fan common fault signal changeover relay contacts. Unfused, Max 3A at 30VDC.

**LOCAL FIRE (C NC NO)**

Local fire common alarm changeover relay contacts. Unfused, Max 3A at 30VDC.

**HOLD (+ -)**

Hold switch monitored input. Current limit Max. 50mA (6K8 EOL).

**ABORT (+ -)**

Abort switch monitored input. Current limit Max. 50mA (6K8 EOL).

**AUTO/MAN (+ -)**

Auto/Manual and Manual only mode selector switch monitored input. Current limit Max. 50mA (6K8 EOL).

## Technical Specification

General Specification	
Enclosure	Steel IP30. Epoxy powder coated Interpon Radon, silver grey
Cabling	Fire resistant screened cable, minimum size 1mm <sup>2</sup> . Max cable length 1Km (20 Ohm). Fire Burn, FP200 or equivalent (max capacitance 1uF, max inductance 1 millihenry).
Temperature range: -5°C to +40°C	Maximum Relative Humidity: 95%
Number of conventional detection circuits	3 for single flood zone area. 6 for dual flood zone area
Works with following conventional detectors	Apollo: S65, Orbis. / Hochiki CDX. / Nittan EV
Approx. dimensions of panel (W x H x D)	363 x 310 x 85(mm) (Single Flood Zone) 436 x 396 x 150 (mm) (Two Flood Zones)

Power Supply Specification		
Mains supply	230VAC +10% / -15% 50Hz max current 0.74Amp (35W) for Single flood zone  230VAC +10% / -15% 50Hz max current 2.1 Amp (100W) for Dual flood zone	
Mains supply fuse	2 Amp (T2A 250V) 35W unit 4 Amp (T4A 250V) 100W unit	Not accessible for servicing. Internal to switched mode power unit
Power supply rating	1.2 Amps total including battery charging for single flood zone  3.4 Amps total including battery charging for single and dual flood zones	Maximum load shared between outputs = 1 Amp single flood zone, 3 Amp single and dual flood zones
Power supply output voltage	19.8 - 29.7VDC	Tolerance +/- 0.1%
Maximum continuous load for battery standby (I max A)	I max A = 650mA for single flood zone  I max A = 930mA for single and dual flood zone	I max B not specified
Minimum current drawn by panel	Single Flood Zone = 168mA  Single and Dual Flood Zone = 240mA	
Maximum ripple voltage	150 mV p-p (Both single and dual)	Supply and charger fault monitored

Min/max battery size and type	2 x 3.2 Ah 12volt VRLA (minimum) 2 x 7Ah 12volt VRLA (1 Flood zone)	Small cabinet
	2 x 18.0Ah 12volt VRLA. (1 or 2 Flood zone) Use Yuasa NP range batteries	Large cabinet
Battery charging voltage	27.3VDC nominal at 20°C for single and dual flood zones	Temperature compensated
Battery charging output current	700mA (Both sizes) Current limited	Charging suppressed During Alarm Condition
Battery high impedance fault (Batt Hi Z)	Resistance > 1 Ohm	1-hour reporting time
Max current drawn from batteries	5 Amps with main power source disconnected. Battery fuse 3.15A (5x20 glass, quick blow)	
Min current supplied by PSU I min	70mA for both single and dual flood zones	

<b>Electrical Specification Inputs &amp; Outputs – TPC2879-206 PSU PCB for Single and Dual Flood Zone Panels</b>		
Terminal capacity	0.5mm <sup>2</sup> to 2.5mm <sup>2</sup> solid or stranded wire.	
PSU Input +/- to PCB	29.5VDC supply input. Diode protected for reversal and independent short circuit. Max current 5 amps.	Max input current 5 amps. Input voltage 29.5VDC to 30VDC.
28V+, 0V- power output	28VDC supply output for fire alarm accessory relays etc. Max continuous use = 400mA.	Fused at 500mA. Fuse = 500mA resettable fuse.
Common fire relay	Fire relay contact. Clean C/O. Max 3A at 30VDC.	Unfused
Common fault relay	Maintained fault relay contact. Clean C/O Max 3A at 30VDC.	Unfused
Inputs: CC, PULSE	Switched -ve inputs, connect to 0V to trigger. Max input voltage = 30VDC. Non-latching, max resistance 100R.	Protected via 10K Ohm impedance, 3v6 Zener diode.
SOUNDERS 1 & 2	28VDC polarity reversal monitored sounder outputs to fire alarm devices. 6K8 Ohm 5% 0.25W EOL resistor.	Monitoring current limit 28mA, fused at 500mA. Typical max load 22 devices at 18mA each per circuit.
PBUS Output + / -	RS485	RSU Comms, fused at 20mA
Temp Sense Input * *	Input for connection of battery temperature sensor, Attach to central point of sealed lead acid battery pair.	Thermistor TTC5103 10,000 Ohms at 25°C.

<b>Electrical Specification Inputs &amp; Outputs – TPC2883-206 Gas Card PCB – 1 fitted for Single Flood Zone Panel, 2 fitted for Dual Flood Zone Panel</b>		
Zone 1 - 3 +/- for single flood area Zone 1 - 6 +/- for dual flood area	Fire alarm zone circuits. Conventionally wired detection circuit. 6K8 Ohm 5% 0.25W EOL resistor.	Monitoring current limit 42mA. Max 32 devices per zone.
1 <sup>st</sup> Stage Sounder Output +/- 2 <sup>nd</sup> Stage Sounder Output +/-	28VDC polarity reversal monitored sounder output to fire alarm devices. 6K8 Ohm 5% 0.25W EOL resistor.	Monitoring current limit 28mA, fused at 500mA. Typical max load 22 devices at 18mA each per circuit.

<p>EXT OP +/-</p>	<p>Extinguishant Release Output. 28VDC polarity reversal monitored output to Solenoids or Metron actuators.  1N4002 diode EOL, Circuit parameters learnt during commissioning.</p>	<p>21- 30VDC: 2A continuous rated for solenoids;  3A at 450mS available for Metron actuators</p>
<p>Monitored inputs (6): FLOW SW, PRESS SW, MAN REL, HOLD, ABORT, AUTO/MAN (+/-)</p>	<p>End of line resistor 6K8, Thresholds 8K to 1K2 Normal, 1K1 to 150R active (nominal 470R), 150R to 0R Short circuit</p>	<p>Monitoring current limit 14mA</p>
<p>1<sup>ST</sup> STAGE RELAY, 2<sup>ND</sup> STAGE RELAY, EXTRACT FAN, LOCAL FIRE RELAY C/NC/NO</p>	<p>Auxiliary relay contacts. Clean C/O. Max 3A at 30VDC.</p>	<p>Unfused</p>



# INSTALLATION

## Safety

### Important notice:

Please read this manual before handling the equipment and observe all advice given within it.

### Important Notes:

The product must be installed, commissioned and maintained for operation in accordance with the instructions and the applicable wiring codes of practice and national standard regulations for fire systems appropriate to the country and location of the installation.

This equipment is designed to be operated from 230V AC 50/60 Hz mains supplies and is of Class I construction. As such it must be connected to a protective earthing conductor in the fixed wiring of the installation. Failure to ensure that all conductive accessible parts of this equipment are adequately bonded to the protective earth will render the equipment unsafe.

## Warnings

	<p><b>Warning Sign:</b> Before installation refer to the ratings shown on the label inside the product and to the 'Specifications Chart' in this document. If you are unclear on any point, please DO NOT proceed. Contact the manufacturer or supplier for clarification and guidance.</p> <p>Only trained service personnel should undertake the Installation, Programming and Maintenance of this equipment.</p>
------------------------------------------------------------------------------------	---------------------------------------------------------------------------------------------------------------------------------------------------------------------------------------------------------------------------------------------------------------------------------------------------------------------------------------------------------------------------------------------------------------------

## Cautions

<p><b>Equipment Guarantee</b></p>	
	<p>This product has been manufactured in conformance with the requirements of all applicable EU Council Directives and is not guaranteed unless the complete system is installed and commissioned in accordance with the laid down national standards.</p>
<p>This product has been designed to comply with the requirements of the Low Voltage Safety and the EMC Directives. Failure to follow the installation instructions may compromise its adherence to these standards.</p>	

Waste Electrical and Electronic Equipment Directive



## ESD Precaution

This particularly applies to the precautions necessary to avoid Electro-Static Discharge.

**Attention** – Observe precaution for handling electro-static sensitive devices.



This equipment is constructed with static sensitive components. Wear an anti-static earth strap connected to panel enclosure earth point. Before installing or removing any printed circuit boards remove all sources of power (mains and battery).

**Note:** This equipment is a piece of class 1 equipment and must be earthed.

## Installing the System

### Environment

The site chosen for the location of the panel should be clean, dry and not subject to shock or vibration. Environments where there is damp, salt air, water ingress or extremes of temperature must be avoided. The temperature should be in the range of -5°C to +40°C, and the relative humidity should not exceed 95%.

### Mounting the Cabinet

Secure the cabinet to the wall using the four indented holes in the back of the cabinet. Ensure the cabinet is mounted level and in a convenient location for it to be operated and serviced.

Recommended screws size is M 4.0 \* 38mm.

External cables should pass through a suitable gland and fitted to the cabinet via preformed knockouts at the top and rear of the cabinet. Any unused knockouts must be securely blanked off.

Knockouts should be removed with a sharp tap at the rim of the knockout, using a 6mm broad bladed screwdriver. Use of excessive force will damage the enclosure around the knockout.

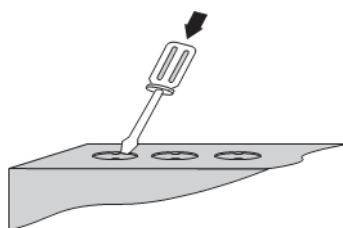

## Mains Connections

**Note:** All connection must be carried out in accordance to local requirements and regulations.

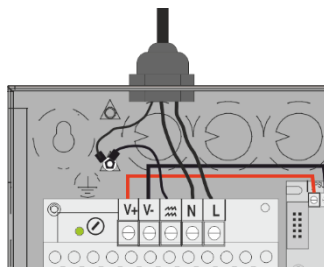

## Connecting the Batteries

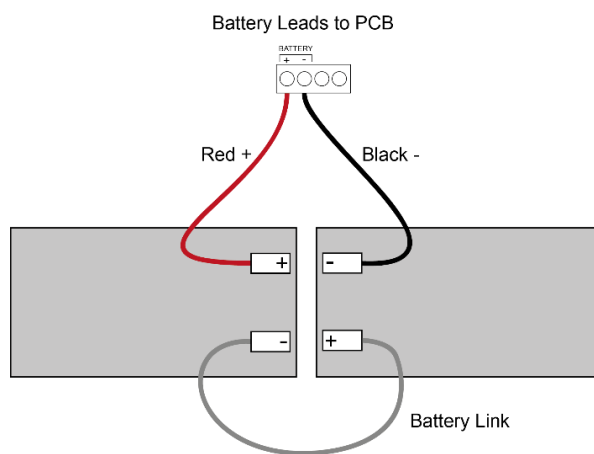

**Note:** In the event of mains failure, the battery charger circuit will protect the batteries from full discharge by disconnecting them when they reach below 19v. When the mains supply is restored the batteries will be automatically reconnected.

**Note:** If the mains are connected before the batteries, the panel will show a Power Supply fault for up to 1 minute until the monitoring cycle has finished polling. This is normal. If the fault doesn't clear after 1 minute, check connections.

Connect the red lead to the positive (+) terminal of battery No.1 and the black lead to the negative (-) terminal of battery No.2. Connect the negative terminal of battery No.1 to the positive terminal of battery No.2, using the supplied link cable.

## Battery Charging Voltage Checks

The battery charging voltage is factory calibrated to 27.3VDC +/- 0.2V at 20°C. This should not normally require adjustment. Where battery problems are experienced, the following information should be considered.

Quiescent current and alarm current details for standby battery calculations:

- a) If a battery is disconnected from the charger, no voltage will appear on the output leads or terminals, due to intelligent battery controls.
- b) Check the power supply voltage at the PSU supply input terminals. With the batteries disconnected the voltage should be 29.0VDC +/- 0.2V.
- c) To test the batteries, turn off the mains and see if the system will run on the batteries. Check the battery voltage, which should be 26.8V for a good battery or 22V for a flat battery.
- d) The power supply voltage can be adjusted using the potentiometer on the power supply module, checking at the 28V & 0V output terminals with a calibrated voltmeter. Batteries should be disconnected and the Access Level 3 DIL switch should be set to 'ON', which will override the temperature compensation controls. Carefully adjust the voltage to 29.0VDC +/- 0.2V. When completed, switch off Access Level 3 DIL switch and re-connect the batteries.
- e) When the panel is re-charging a low battery, it should be possible to see the voltage across the batteries increase gradually. If this is not occurring, the batteries or the panel may be faulty.

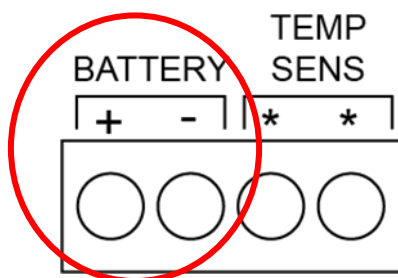

## Battery Charging Voltage Calibration

Should the battery charging voltage require calibrating (i.e. following replacement of the main board), proceed as follows:

- Turn **Activate Controls** key clockwise to **On**
- or
- Use the keypad to enter Authorised User (Access level 2) code 1111:
  - Press ✓ key
  - Use Up/Down arrow keys to increase/decrease the number value
  - Use Left/Right arrow keys to move to the next digit in the 4-digit sequence
  - When all 4 digits have been set to the code 1111, press the ✓ key again
- The **Main Menu** will become available for operation
- On the **Main Menu**, use Left/Right arrow keys to move cursor box to **Report** menu
- Press Enter ✓ key to select the **Report** menu
- Under **Report Menu**, use Left/Right arrow keys to highlight the **BATTERY** option, and then press Enter ✓ key to select it
- **BATTERY STATUS** menu will display the following:

**TEMPERATURE: nn.nn**

**BATTERY VOLTS:** nn.nn



**CHARGE:** nn.nn



**Current:** n.nn

**DAC OUTPUT:** nnn.nn

**VREF INT:** nnnn

**CALIBRATION:** n.nnnnnn

- Place Multimeter probes onto battery input terminals and observe the Battery Volts reading
- Using Up/Down arrow keys; adjust the calibration until the **BATTERY VOLTS** figure, shown on the panel LCD screen, matches the Battery Voltage as measured on the Multimeter
- Press return  key, or Enter  key, to accept the changes and return to the **Report Menu**. A short acknowledgement sound will be present.

**Note:** Do not allow the menu to time-out, before pressing the return  key or Enter  key, as the calibration changes made will be lost and the calibration procedure will need to be repeated.

### Detection Zone Inputs

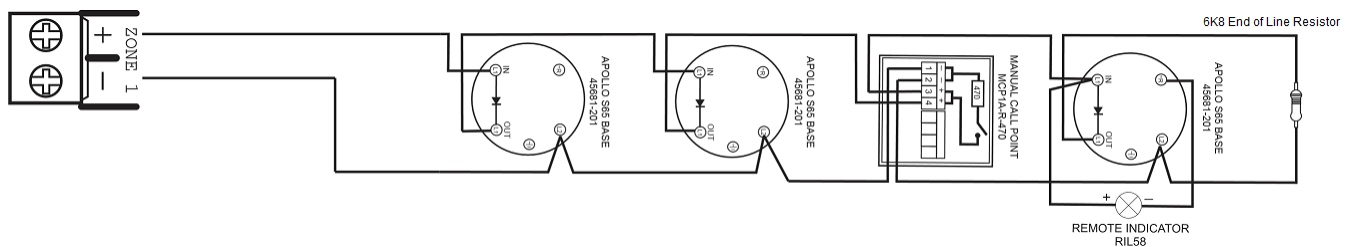

A maximum of 32 detectors per zone only can be fitted.

Three conventional detection zone inputs are provided. These are nominally 26VDC circuits and are current limited.

The circuits are monitored for open and short circuits. For normal monitoring, a 6K8Ω End-of Line resistor is required. Maximum line resistance 32Ω.

The circuit is designed to be compliant with conventional detectors and call points with an alarm resistance of 470Ω (industry standard accepted) or 220Ω for priority alarms.

Connect the detectors and manual call points (if required) in series with no spurs. Connect the end-of-line resistor across the terminals of the last device.

### Intrinsic Safe Connections

The Zone Circuit can be configured for use with Intrinsic Safety detectors and barriers: please see the programming section.

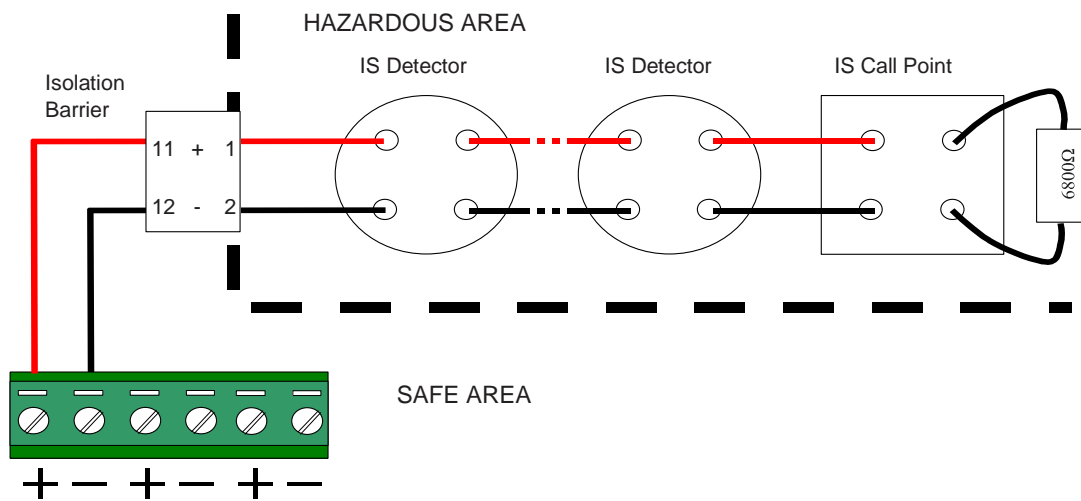

The recommended isolation barrier is an MTL Model: 5561 Only use intrinsic safe detectors and call points.

The number of devices permitted, and cables will depend on the IS classification – refer to the detector manufacturers’ information for further appropriate IS zone classification.

### Sounders / Monitored Output Circuits

Four conventional 24VDC programmable and monitored sounder style output circuits are provided for single flood zone, and six conventional 24VDC programmable and monitored sounder style output circuits are provided for dual flood zone.

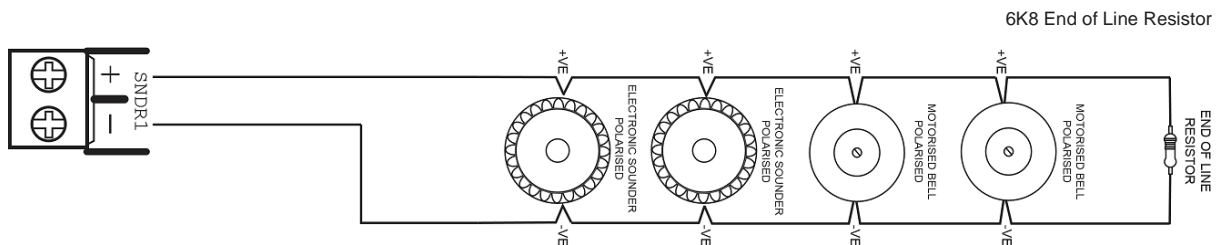

The sounder outputs can be configured to turn on continuously or to pulse (1s ON / 1s OFF).

The sounder outputs are monitored for open and short circuit conditions using reverse polarity signals.

The outputs can be configured to be non-silencing or silencing. Sounders must be equipped with an in-built blocking diode that prevents the sounder from taking power when the output is in the supervising condition.

An End-of-Line Resistor of value 6k8Ω ½ Watt must be fitted to the last sounder / bell.

## Relay Outputs

The panel is equipped with six relay outputs. Each output is unsupervised with volt-free changeover contacts rated at 30VAC/DC, 1A, resistive.

The Fault Relays and Fire Relays are fixed to indicate their respective conditions.

The Fault Relay is normally activated. It will de-energise on any fault condition from an active zone including total loss of power.

Local Relay operates on activation of a zone that is part of the extinguisher release circuitry, or when the panel mounted (or remote manual) release pushbutton is pressed. The relay remains activated until the panel is reset. All Relay outputs are programmable.

Extract Fan Relay operates when an authorized (Access Level 2) user selects Start Extract Fan, after the flooding time has elapsed (without a reset). This allows a flooded area to be vented of extinguishing medium.

Local Fire Relay operates on activation of a fire condition in a Flood Zone.

Stage 1 Relay has a default operation, which is ON during the pre-activation, activation and release stages.

Stage 2 Relay will come ON only during the release stage. This status is settled by default and can be changed.

Both relays, for stage 1 and stage 2, are fully programmable, and they can take the following values:

- a) ON / OFF
- b) Pulsing 1 sec ON and 1 sec OFF

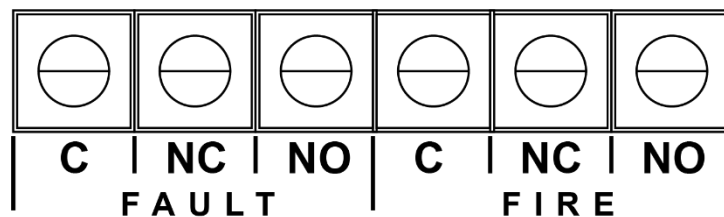

## Additional Relays

If additional relays are required, then install the OPCARD-8 8-Way Relay card to piggy-back onto the COMs A header on the PSU Card

Connect the 10-Way ribbon cable between the relay card and the main display card – the connectors are polarised to prevent incorrect connection.

8 changeover volt-free relay outputs are provided. Each is rated at 30VAC/DC, 1A, resistive. All Relay outputs are programmable.

## Inputs - Class Change and Pulse

### Class Change

Switch (-ve) inputs, which cause the common sounder outputs to operate.

**Note:** Stage sounders will not be affected unless programmed to do so (see program details).

### Pulse

Switch (-ve) inputs which cause the common sounder and detection zone stage sounder's outputs to pulse.

**Note:** Stage sounders will not be affected unless programmed to do so (see program details).

### PBUS

RS-485 local peripheral bus (P-BUS) circuit is for control of Remote Status-indicator Units (RSU), It is not intended for networking or repeaters.

Maximum distance 1000m. Maximum line impedance 50Ω.

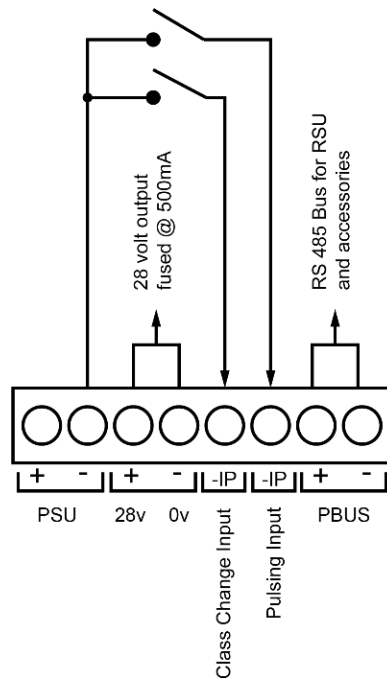



### Monitored Input Wiring

Six monitored input connections are available on the panel Gas Card for each Flood Zone: Manual Release, Flow Switch, Pressure switch, Auto/manual only Mode, Hold and Abort.

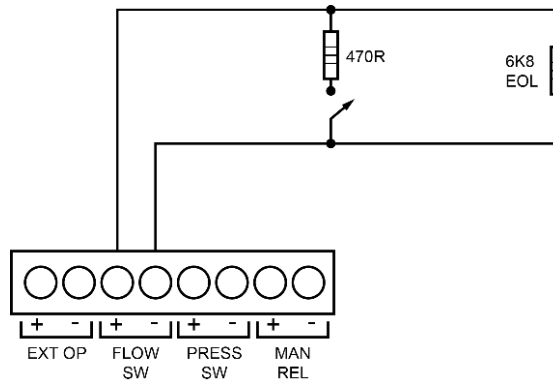

Figure Above: Typical Monitored Input Wiring

A 6k8 end-of-line resistor must be connected across the terminals of last device on each circuit to allow the wiring to be line monitored for open and short circuit faults.

**Note:** Circuits not used must have a 6k8 resistor fitted at the panel terminals.

### Extinguishing Actuator Output Wiring

The circuit is monitored for both open and circuit conditions. No EOL resistor needed.

The output can supply a continuous 2A current for solenoid style actuators or can provide a 3A (15mS) pulse for igniting style actuators, subject to input power.

Output type is configurable – please refer to Configuring the System section.

### Igniting Actuators

The circuit is current limited and one to four igniting actuators can be wired in series without special requirements.

No additional resistance is required in the circuit. Maximum line impedance 7Ω including the internal resistance of the actuators.

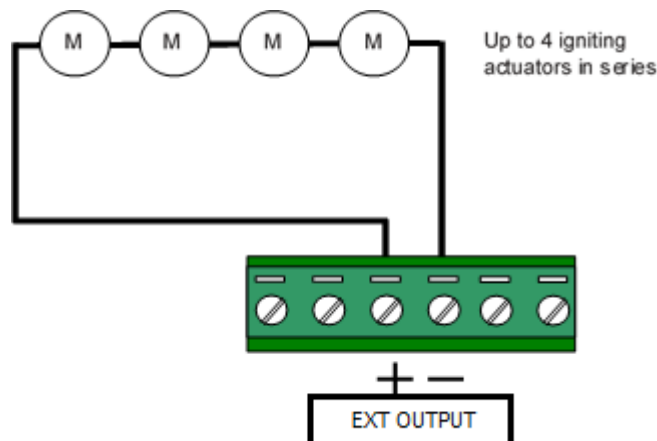

## Solenoid Actuators

A Back-EMF diode must be fitted across the solenoid coil. Observe polarity – see diagram below. Coil resistance 25Ω-200Ω.

Maximum line impedance 1.5Ω -5.0Ω depending on coil impedance – see calculation below.

Two solenoids can be connected in parallel. The panel will learn the combined circuit impedance and will indicate an open circuit condition if one of the actuators becomes disconnected.

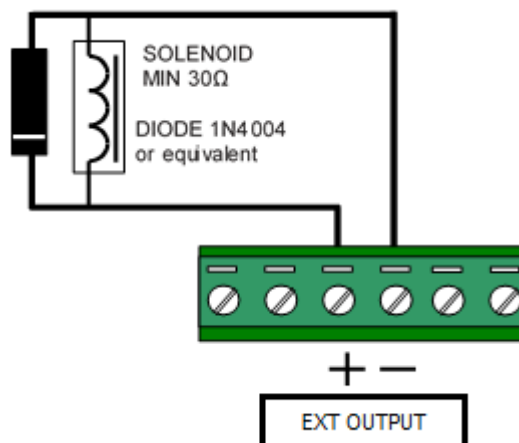

## Solenoid Actuator Circuit Lengths

The voltage drop on the actuator circuit should be calculated to ensure that the voltage at the end of the circuit exceeds the minimum required by the solenoid (typically 18V) when the actuator circuit has minimum output voltage value.

The voltage at the end of the circuit is given by:

- Minimum Actuator Voltage =  $V_{OUT(MIN)} - (I_{ACTUATOR} \times R_{CABLE})$
- Minimum Output Voltage ( $V_{OUT(MIN)}$ ) =  $V_{BAT(MIN)} - 1.5V = 19.5V$
- Actuator Current ( $I_{ACTUATOR}$ ) is the sum of the loads presented by the actuator devices.
- Cable Resistance ( $R_{CABLE}$ ) is the sum of the cable resistance in both cores x cable length.
- Cable Resistance ( $R_{CABLE}$ ) for 1.0mm<sup>2</sup> is 0.036Ω / metre
- Cable Resistance ( $R_{CABLE}$ ) for 1.5mm<sup>2</sup> is 0.024Ω / metre
- Cable Resistance ( $R_{CABLE}$ ) for 2.5mm<sup>2</sup> is 0.015Ω / metre

### Remote Status Unit (RSU) Wiring

The RSU and mini RSU require a 4-wire connection (2 wires for 28V power, 2 wires for RS485 data) from the control panel.

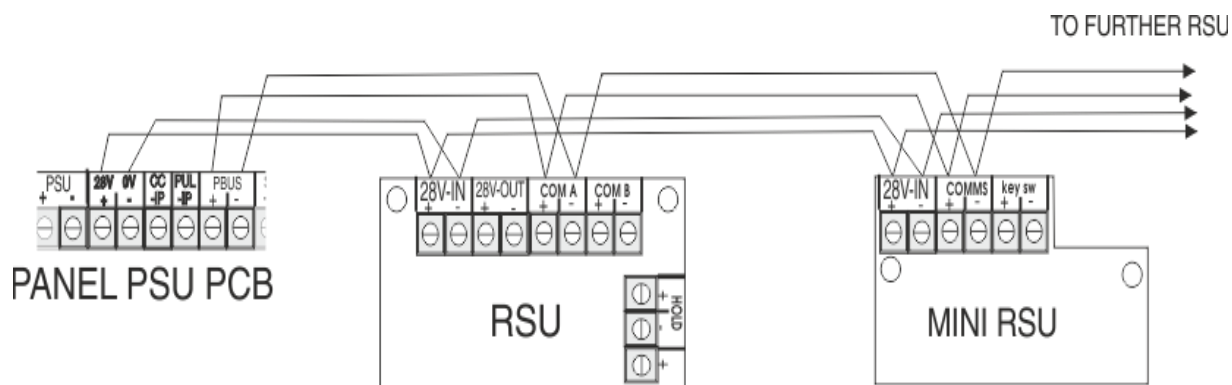

Each RSU has a PCB-mounted DIL switch and must be allocated a unique address between 1 and 16. When Two Flood zones are in use, it is possible to assign RSUs to either Flood Zone.

# OPERATING INSTRUCTIONS

## Panel Control and Indicators







### Control Panel

The Control Panel contains:

- LCD Display Screen
- Control Keypads
- Manual Extinguisher Release
- Status LED Indicators
- Activate Controls Key Operated Switch
- Auto/Manual Mode Select Mode Key Switch

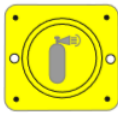

**Keypads**

	<p><b>Resound Alarms</b></p>	<p>Use to resound the alarms after they have been silenced. Can also be used to invoke full evacuation.</p>
	<p><b>Silence Alarms</b></p>	<p>Use to silence the sounders during an alarm condition.</p>
	<p><b>Reset System</b></p>	<p>Resets the panel back to standby mode.</p>
	<p><b>Mute Buzzer</b></p>	<p>Mutes the panels internal fire and fault buzzer. (The buzzer will still blip every 5-6 seconds during a fire or fault condition). This function is operational without the need to activate controls. Also has the numeric value 3 for code entry.</p>
	<p><b>Return</b></p>	<p>Press to exit current menu or command as indicated in the bottom corner of the LCD display.</p>
	<p><b>Scroll Display (arrows)</b></p>	<p>Press to navigate the display messages and menus</p>
	<p><b>Enter (Tick)</b></p>	<p>Press to select the available menus                  Press to confirm selection of a menu option                  Press to confirm some of the configuration options</p>
	<p><b>Manual Release</b></p>	<p>To manually release the extinguishant, pull down the yellow plastic cover and press the yellow button with the extinguishant symbol.</p>

**Status LED Indicators**

LED Name	LED ON	LED PULSING
<b>Zones in Fire 1 - 3</b>	N/A	Indicates alarm condition in zone.
<b>Zone Fault/Test/Disabled/ 1 - 3</b>	Indicates a zone circuit is disabled or in test mode.	Indicates a fault in the zone circuit.
<b>Supply Healthy:</b>	Indicates mains and/or battery supply is present.	N/A
<b>General Fire:</b>	Panel in alarm condition and alarms silenced	Indicates panel is in alarm condition
<b>General Fault:</b>	Indicates Fault has been acknowledged (Mute Buzzer button pressed)  Indicates Disablement present (Disablement LED illuminated)	Indicates one or more faults are present
<b>Disablement:</b>	Indicates one or more circuits have been disabled.	N/A
<b>Test Mode:</b>	Indicates one or more circuits are in test mode	N/A
<b>Sounder Status:</b>	Indicates sounder circuits have been disabled or are in test mode	Indicates a fault on one or more sounder circuits.
<b>Power Supply Fault:</b>	N/A	Indicates a power supply fault on mains power input or battery
<b>Delay Status:</b>	Delays are configured	Delay is running
<b>System Fault:</b>	Indicates a system failure, panel not functional or the internal PCB configuration has not been set up correctly	Indicates the panel has recovered from a system fault.
<b>Release Imminent</b>	Signal to release extinguishant has been activated.	Indicates that the release of extinguishant is imminent.
<b>Gas Released</b>	N/A	Indicates that the release of extinguishant has occurred and the panel has detected the flow of the extinguishant released
<b>Low pressure</b>	Indicates low pressure circuit is disabled or in test mode.	Indicates that the extinguishant cylinder has lost pressure and requires attention
<b>Timer Held</b>	Indicates that the imminent release of extinguishant is temporarily suspended	Indicates a fault in the Hold off circuit

LED Name	LED ON	LED PULSING
<b>Aborted</b>	Indicates that the imminent release of extinguishant has been aborted	Indicates a fault in the Abort Circuit
<b>Flood Zone Fault</b>	Flood zone is disabled or in test mode	A Fault exists which may prevent the release of extinguishant
<b>Manual Only</b>	Indicates that extinguishant can only be released by means of a manual release button.	Briefly indicates during a change of status
<b>Auto / Manual</b>	Indicates that the extinguishant can be released by both the automatic detection of a fire alarm and by means of a manual release button	N/A
<b>Stage one /Two Outputs</b>	Indicates that a stage output(s) is disabled	N/A

## User Controls

Four levels of control, with programmable code entry, are available on the panel:

- General User (Access Level 1)
- Authorised User (Access Level 2)
- Engineer (Access Level 3) (CONFIG Mode)
- Engineer (Access Level 4)

In General User (Access level 1) mode; most of the keypad controls are inactive, to protect the system from unauthorised operation.

The use of a code entry to activate the controls is enabled by default but can be disabled in the Level 3 engineering functions.

Once the panel is powered up, the panel will perform a routine status check. When this is complete, the LCD screen will display any faults found, accompanied by the relevant status LEDs flashing and a warning tone. After clearing any faults found and a successful status check, the Title screen will be displayed. The General User (Access level 1) controls are then available.

### General User Controls

The General User (Access level 1) controls are available when the **Activate Controls** key is set to **Off** and four-digit access code has not been entered.

### Available Functions

The functions that can be performed in Access Level 1 are:

- Manually activate the extinguisher release
- Mute the internal sounder
- View active faults
- Change from General User (Access level 1) to Authorised User (Access level 2); by either entering the four-digit Access codes, or by using **Activate Controls** key switch
- Change from **Auto/Manual** to **Manual Only** mode by using the **Select Mode** key switch.

### Auto / Manual and Manual Only Selection

The default setting for the panel is automatic and manual control (**Auto/Manual**). To select manual only operation:

- Turn the **Select Mode** key switch to **Manual Only**
- or
- From the panel's **User Menu AUTO/MANUAL MODE**.
  - When selected to **Manual Only/MANUAL MODE**, the **Manual Only** LED will illuminate, and the display will show the Gas Area that has been set to manual:

**OTHER**

**A00 F00 D00 O01**

**1: MANUAL MODE AREA 1 ON PANEL**

Manual only operation can also be selected from an RSU or Mini-RSU:

- On a Mini-RSU or RSU panel, turn the **Select Mode** key switch to **Manual Only**
- or
- From the RSU panel's **MAIN Menu AUTO/MAN sub-menu**, select **MANUAL**
  - When selected to **Manual Only/MANUAL Mode**, the **Manual Only** LED will illuminate, and the display will show the Gas Area and the RSU that has been set to manual:



**OTHER****A00 F00 D00 O01****1: MANUAL MODE AREA 1 ON RSU nn**

**Note:** The system may have many inputs for selecting Manual Only Mode, from RSUs or mini RSUs connected to the system. Any one of these set in the manual condition will override the main panel setting. All must be set to automatic to return the status to Automatic/manual mode.

**Authorized User Controls**

The Authorised User (Access level 2) controls can be accessed by:

- Turning the **Activate Controls** key clockwise to the **On** position. The padlock symbol will show unlocked and all the buttons on the keypad will be operational. To deactivate the controls, turn the key back to the **Off** position. The padlock symbol will show locked.

or

- Entering four-digit access code 1111
  - Press the ✓ key
  - Use the Up/Down arrow keys to increase/decrease the number value
  - Use the Left/Right arrow keys to move to the next digit in the 4-digit sequence
  - When all 4 digits have been set to the code **1111**, press enter ✓ key once again
  - The **Main Menu** will become available for operation.

Once the four-digit code is entered, or the **Activate Controls** key is turned to **On**, the LCD unit will display the **Main Menu**. Use the Scroll Control keypad up/down and left/right arrows, and the enter ✓ key to navigate the Access level 2 menu.

**Note:** If the Activate Controls key is in the **On** position, the keypad will remain active.

**Note:** It is not possible to remove the key, whilst it is in the **On** position.

**Note:** The padlock symbol is shown on the LCD screen, to the right of the Time and Date indication.

**Note:** The Access level 2 code 1111 is the factory default. The access code may be changed from the **CONFIG** menu **PANEL** sub-menu.

**Available Functions**

The functions that can be performed at Access level 2 are:

- Resound the alarms
- Silence the alarms
- Reset the system
- Mute the internal sounder
- Access the Authorised User (Access level 2) menu structure, from the icons on the **Main Menu**
- Access the **CONFIG** menu or **CONTROL** menu (Access level 3) Engineer controls, for configuration and commissioning of the system, by entering the Engineer Access level 3 four-digit access code.

**Authorised User Menu Options**

The Authorised user (Access level 2) menu options are available from the **Main Menu**:

- User
- Report
- ENG

## Engineer Controls (Access Level 3)

The Engineer (Access level 3) controls can be accessed by:

- From the Authorised User (Access level 2) **Main Menu**, use Left/Right arrow keys to move cursor to:
  - **CONFIG** menu
  - or **CONTROL** menu > **FLOODING** icon
- Press ✓ key to select **CONFIG** menu, or **CONTROL>FLOODING** sub-menu. The digital display will show the following message:

**Enter Level 3 Access Code**  
0 \_ \_ \_
- Use the keypad to enter code 3333:
  - Press ✓ key
  - Use the Up/Down arrow keys to increase/decrease the number value
  - Use the Left/Right arrow keys to move to the next digit in the 4-digit sequence
  - When all 4 digits have been set to the code 3333 press ✓ key once again. The Access level 3 menu will become available for operation.

Use the Scroll Control keypad up/down and left/right arrows, and the enter ✓ key to navigate the Access level 3 menu.

**Note:** The Access level 3 code 3333 is the factory default. The access code may be changed from the **CONFIG** menu **PANEL** sub-menu.

### Available Functions

The functions that can be performed at Access level 3 are:

- Set the panel to automatically learn what internal cards are fitted within the panel, and what remote units (connected via the RS-485 Peripheral BUS) and devices (detectors, sounders, call-points, etc.) are connected to the internal cards.
- Configure the outputs for the various external devices (detectors, sounders, etc.).
- Reset panel to factory defaults
- Reset four-digit passcodes
- Configure the various options for the release of extinguishant, including; delays on release, gas zone flooding, extraction of extinguishant.

### Engineer Menu Options

The Engineer (Access level 3) menu options, available from the **Main Menu**, are:

- CONFIG
- CONTROL:
  - FLOODING

## Engineer Controls (Access Level 4)

The Engineer (Access level 4) controls can be accessed by:

- From the Authorised User (Access level 2) **Main Menu**, use Left/Right arrow keys to move cursor to **Report** menu icon and press ✓ key to select
- Under **Report Menu** select the **COUNTER** option and then press ✓ key to access it.

- The **ALARM COUNT** sub-menu will open, and the following information will be available:  
**ALARM COUNT: nnnn** (number (n) of alarm events that have occurred)  
**LAST ALARM AT: dd-MMM-yy hh:mm:ss** (date and time when the last event happened)  
**HOLD DOWN SELECT TO RESET:**
- To reset the alarm count, press and hold down ✓ key and the following will be displayed:  
**Enter Level 4 Access Code**  
**0 \_ \_ \_**
- Use the keypad to enter code 4444:
  - Press ✓ key
  - Use the Up/Down arrow keys to increase/decrease the number value of the first digit in the 4-digit sequence.
  - Use the Left/Right arrow keys to move to the next digit in the 4-digit sequence
  - When all 4 digits have been set to the code 4444 press ✓ key once again.
- This action will clear to zero the value of any Alarm Count (if more than zero). A short acknowledgement sound will be present.
- Press return  key to return to **Report Menu**.

### Available Functions

The functions that can be performed at Access level 4 are:

- Reset the ALARM COUNT

### Engineer (Access Level 4) Options

The Engineer (Access level 4) option prevents accidental resetting of the Alarm count data.

## Panel Alarm Conditions

### Fire Alarm Condition

Depending on the panel type (single or double Flood Zone) and the Gas Cards installed, the panel can have one or two Flood Zones. Each Flood Zone can have 1 – 3 Detection Zones. The panel will enter a fire alarm condition if:

- One or more detectors in one or more Detection Zone are triggered
- A call point is manually triggered

The display shows the location/origin of the fire alarm, and the total number of Detection Zones in a fire alarm condition.

If two or more Detection Zones enter the fire alarm condition, the display shows the location of the last zone to enter a fire alarm condition.

When in the alarm condition:

- The **General Fire** LED and the respective Detection Zone's **Fire Zone** LED will be illuminated.
- The general fire alarm bells/sounders (SOUNDER 1/SOUNDER 2) will activate (depending on how they are programmed to respond).

To silence the internal buzzer, press the **Mute Buzzer** button.

To silence the bells, press the **Silence Alarm** button.

To reset the panel, press the **Reset System** button.

The status of the extinguishant release is also indicated. If a fire alarm occurs in a Detection Zone that has no effect on the extinguishant control, then the display shows **UNAFFECTED**.

### Activated/Released Condition

The extinguishant Activated/Released condition is established for a Flood Zone, when:

- Two or more detectors in a single Detection Zone, or one or more detectors within two or more Detection Zones, are triggered
- When a manual **EXTINGUISHANT RELEASE** button, in the Flood Zone that is in an alarm state, is pressed.

The Detection Zones that must be in a fire alarm condition, before the activated condition is invoked, depends on the programming of the panel during installation.

**Note:** In accordance with EN 12094-1, the activated/released condition may be established without the detection of a fire alarm or manual release. If the panel detects the release of extinguishant, it will immediately indicate the released condition.

#### Under Default Condition - (Flow SW Y/N to Y):

If, during configuration of the system's Gas Card options, the Flow Switch is set to Y (for the default condition), the extinguishant status is indicated as follows:

#### Release Imminent (Stage 1)

When the release/activated condition is established:

- The **Release Imminent** LED is illuminated on steady.
- The display indicates **RELEASE IMMINENT** and shows a countdown timer with the number of seconds remaining before the extinguishant is released.
- Timer starts counting downwards to '0'
- The release imminent sounder (1st Stage Sounder) will be activated within the Flood Zone in the Activated/Released condition, to warn that extinguishant release is imminent.

## Release (Stage 2)

When the timer reaches '0' the extinguishant is released:

- **Release Imminent** LED is off
- Release Imminent sounder (1st Stage Sounder) is silenced
- Flow switch is triggered, starting the release of extinguishant (Flow switch would need a trigger-470Ω).

After trigger, extinguishant release is started and:

- **Gas Released** LED is illuminated flashing
- Gas Released sounder (2nd Stage Sounder) is activated.
- The display shows **RELEASED** and a countdown timer, with the time elapsed since the start of the release of extinguishant.
- Timer counts downwards to '0'.

When the timer reaches '0', the extinguishant is fully released. When the discharge is complete (either time elapsed or flow detected):

- Display indicates the extinguishant has been released.
- **Gas Released** LED continues to Flash
- Gas released sounders (2nd Stage Sounder) will continue to be activated, to warn that extinguishant has been released.

## Flooding (Stage 2)

During this phase, the now released extinguishant spreads out and settles in the flood zone:

- **Gas Released** LED continues to Flash.
- The display shows **FLOODING** and a countdown timer, with the elapsed time since the zone flooding began.
- Timer starts counting downwards to '0'
- Gas Released sounders (2nd Stage Sounder) will continue to operate.

## Extract (Stage 2)

When the timer reaches '0', flooding is complete and (if programmed), the panel will automatically activate the output to control the extract fan:

- **Gas Released** LED continues to Flash.
- The display shows **EXTRACT** and a countdown timer, with the elapsed time since the extinguishant extraction began.
- Timer starts counting downwards to '0'
- Gas released sounders continue to operate.

When the timer reaches '0', extraction is complete:

- the display indicates finished and prompts that the panel can be reset
- Gas Released sounders (2nd Stage Sounder) will be silenced.

To reset the panel, press the **Reset System** button. This resets the Activated Condition/Release Signal.

### Panel Programmed Condition - (Flow SW Y/N to N - Auto)

If, during configuration of the system's Gas Card options, the Flow Switch is set to N - Auto (for the panel programmed condition), the extinguishant release status is indicated as follows:

#### Release Imminent (Stage 1)

When the release/activated condition is established:

- The **Release Imminent** LED is illuminated steady.
- The display indicates **RELEASE IMMINENT** and shows a countdown timer with the number of seconds remaining before the extinguishant is released.
- Timer starts counting downwards to '0'
- Release imminent sounder (1st Stage Sounder), for the Flood Zone in the alarm condition, will be activated to warn that extinguishant release is imminent.

#### Release (Stage 2)

When the countdown timer reaches '0':

- **Release Imminent** LED is Off
- Flow switch is triggered, starting the release of extinguishant (Flow switch would need a trigger-470Ω).

After trigger, extinguishant release is started and:

- **Gas Released** LED illuminated steady.
- Gas Released sounder (2nd Stage Sounder) is activated.
- The display shows **RELEASED**, and a countdown timer with the time elapsed since the start of the release of the extinguishant.
- Timer counts downwards to '0'.

When the timer reaches '0', the extinguishant is fully released. When the discharge is complete (either time elapsed or flow detected):

- Display indicates the extinguishant has been released.
- **Gas Released** LED remains on
- Gas Released sounders (2nd Stage Sounder) will continue to be activated, to warn that extinguishant has been released.

#### Flooding (Stage 2)

During this phase, the now released extinguishant spreads out and settles in the flood zone:

- The display shows **FLOODING**, together with a countdown timer showing the time elapsed since the start of the zone flooding began.
- Timer starts- counting downwards to '0'
- Gas Released sounders (2nd Stage Sounder) will continue to be activated, to warn that extinguishant has been released.

## Extract (Stage 2)

When the timer reaches '0' flooding is complete and (if programmed), the panel will automatically activate the output to control the extract fan:

- The display shows **EXTRACT**, and a countdown timer with the time elapsed since the start of the zone extraction began
- Timer starts counting downwards to '0'
- Gas released sounders (2nd Stage Sounder) will continue to be activated, to warn that extinguishant is in the Flood Zone.

When the timer reaches '0', Extract is complete:

- The display indicates finished and prompts that the panel can be reset
- Zone alarm sounders will be silenced.

To reset the panel, press the **Reset System** button. This resets the Activated Condition/Release Signal.

**Note:** In accordance with EN 12094-1, the ECD shall not permit a reset until either the RELEASED condition has been established (flow detected) or until after a programmable time following activation of the mechanism to release the extinguishant.

## Hold Condition

If any Extinguishant Hold Off button is pressed and held in a Flood Zone that is in a Fire Alarm condition, and the Release Imminent countdown has started, the Release Imminent countdown for that Flood Zone is held for as long as the button is pressed.

The display shows the **COUNTDOWN ON HOLD** condition and the **Timer Held** LED is illuminated.

When the HOLD button is released, the Release Imminent countdown is reset to the beginning and restarts.

## Abort Condition

If an Extinguishant Abort button is activated; in a Flood Zone that is in a Fire Alarm condition, the Release Imminent countdown for that Flood Zone is aborted.

The display prompts for the panel to be reset and the **Aborted** LED is illuminated.

Ensure that the Extinguishant Abort button is de-activated and then press the **Reset System** button.

**Note:** In accordance with EN 12094-1; it is a requirement that for a Dual Flood Zone panel, a common output is needed to provide an indication of HOLD and ABORT activation from either flood zone. Refer to Configuring the System, Set Common Output for HOLD & ABORT.

## Fault Condition

If the panel detects a fault condition, the display will indicate the number and nature of the fault(s). The internal buzzer will sound with an intermittent tone and the **General Fault** LED, and any other specific Fault LED indications, will be illuminated.

Press the Up/Down arrow keys to scroll through the list of faults.

Press the **Mute Buzzer** button to silence the internal buzzer.

**Note:** The fault condition is non-latching (except System Fault) and the indications will automatically be cleared when the fault is remedied. Press the **Reset System** button to clear a System Fault.

**Note:** If silenced, the buzzer will re-sound when a new fault occurs.

If a fault is detected in the second stage sounder circuit, the release countdown timer is halted and extinguishant release is aborted. This is to prevent extinguishant release if a sounder fault prevents people from being alerted to evacuate the release zone.

## Functionality During a System Fault

A system fault is indicated when a processor controlling a function in the panel has a watchdog time out, or processor failure. In the event of a system fault, the board affected may not be functional. The following indications may be observed:

- Display Board (Main control board)
  - **System Fault** LED illuminated only
  - Continuous buzzer sound.
  - Display board (main control board) is halted and no other indication or control is possible.
  - Fault relay is activated.
- Gas Card Boards
  - **System Fault** LED illuminated continuous
  - **General Fault** LED illuminated pulsing
  - Continuous buzzer sound
  - LCD announces Gas card 1 or 2 offline fault
  - Fault relay is activated.
- Extension LED board (Gas Area 2 LEDs)
  - **System Fault** LED illuminated continuous
  - **General Fault** LED illuminated pulsing
  - The extension LED Board is halted
  - Fault relay is active, Fire alarms can still be detected and controlled by the panel.
- Power Supply Board
  - **System Fault** LED pulsing
  - **General Fault** LED pulsing
  - **Power Supply Fault** LED pulsing
  - Continuous buzzer sound
  - Fault relay activated.
  - Mains or battery power will still operate the panel. Batteries will not be charging
  - Indications will remain until the fault is rectified and the panel is reset.
  - Remote Status Units will cease to function.
- System Fault recovery
  - **System Fault** LED illuminated pulsing
  - **General Fault** LED illuminated pulsing
  - Pulsed buzzer (fault tone), indicates a system fault has occurred, and the affected board has recovered.
  - The indication will remain until the panel is reset.



## CONFIGURING THE PANEL

When the system is installed and is ready to be commissioned, configuring the system consists of:

- Use the **CONFIG PANEL** menu **LEARN** option - On initial commissioning; or following removal or addition of external device(s) (sounder, call point, detector, etc.), set the system to automatically learn what internal cards, external devices and RSUs are connected.
- Set Common Output for HOLD and ABORT – On initial commissioning; or following removal or addition of sounders, set any of the outputs for use as a common output indication, to show activation of HOLD and ABORT functions.
- Panel Setup (**User** menu) – Set Auto/Manual Modes, Display brightness, Internal Buzzer volume, system Time and Date, etc.
- Device Outputs (**CONFIG** Menu) – Set configuration options for the panel (sounder options, reset password, set inhibit time, reset panel defaults, etc.), internal cards (timer options, etc.), External Devices (device names, output options, etc.).
- Extinguishant release (**CONTROL** Menu) – Set configurable options for extinguishant release, including for FLOOD and EXTRACT.

### Accessing the Menu Structure

Power-on the panel and wait for it to perform a routine status check. Any faults detected will be displayed, accompanied by a warning tone. Press the **Mute Buzzer** button to silence the warning tone. Resolve any faults before proceeding.

Next proceed by pressing the ✓ button, the LCD unit displays the following Access Level 2 Menu (see picture below):

To access the menu structure:

- Turn **Activate Controls** key switch clockwise to **On**
- or
- use the keypad to enter Authorised User (Access level 2) code **1111**:
    - Press ✓ key to select Access level 2. The digital display will show the following message:  
**Enter Level 2 Access Code**
      - Use Up/Down arrow keys to increase/decrease the number value
      - Use Left/Right arrow keys to move to the next digit in the 4-digit sequence
      - When all 4 digits have been set to the code **1111**, press the ✓ key again
      - The LCD unit displays the Access Level 2 **Main Menu** (see picture below), which is available for operation

**Note:** Access level 2 Menu will deactivate after 30 sec if not used.

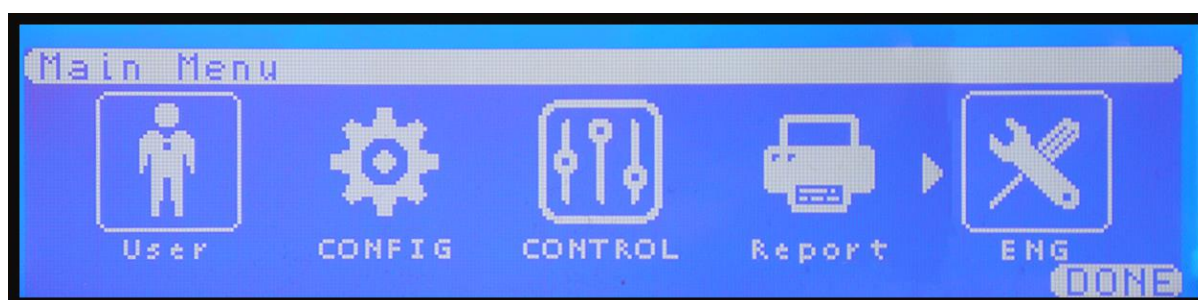

The Box surrounding the menu icon is the cursor, this is used to navigate through the menu options by using the Left/Right arrow keys to select required menu option and then press ✓ button.

The Left/Right and Up/Down arrow keys can then be used to access further sub-menus and options, within the main menus, and then press ✓ button to select required sub-menu or option and to make changes to a selected option.

Where there are options that have adjustable times, these are altered with the Up/Down arrow keys followed by pressing ✓ button when required time is reached.



Use the return  key to exit all menus and options.

## Learn System

To set the system to automatically learn what internal cards, external devices and RSUs are connected, access the **CONFIG PANEL** menu's **LEARN** sub-menu:

- On the **Main Menu**, use Left/Right arrow keys to move cursor to **CONFIG** menu icon
  - Press ✓ key to select **CONFIG** menu. The digital display will show the following message:
 

**Enter Level 3 Access Code**
  - Use the keypad to enter code **3333**:
    - Press ✓ key
    - Use the Up/Down arrow keys to increase/decrease the number value
    - Use the Left/Right arrow keys to move to the next digit in the 4-digit sequence
    - When all 4 digits have been set to the code **3333** press ✓ key once again. The Access level 3 menu will become available for operation.
- On the **CONFIG Menu**, highlight **PANEL** option and then press ✓ key to gain access to it.
- Next highlight the **LEARN** option, under the **CONFIG PANEL** menu and press ✓ key to select it.
- The system will perform a learning routine, in order to acknowledge the Internal Cards installed, the External Devices connected to it, and the P-BUS (Peripheral BUS, which is achieved using a RS485 network) connection. The following information will be displayed in turn, each accompanied by a progress bar:
  - **LEARNING INTERNAL CARDS:**
  - **LEARNING EXTINGUISHANT:**
  - **LEARNING P-BUS:**

- On completion of the learning routine, the **LEARN PANEL** sub-menu will display all the internal cards found connected, or not, indicated by **YES** or **NO**:  
**-INTERNAL CARDS-**  
1: PSU CARD: YES/NO  
2: GAS ONE: YES/NO  
3: GAS TWO: YES/NO  
4: AREA Two Fascia: YES/NO  
5: Relay ONE: YES/NO  
6: Relay TWO: YES/NO
- Press return  key to accept.
- **EXTINGUISHANT OUTPUT:** The **LEARN PANEL** menu will display the extinguishant release options:  
**- EXTINGUISHANT-**  
**Area 1: Solenoid/One Metron/Two Metron**  
**Area 2: Solenoid/One Metron/Two Metron**
- Use the Up/Down arrow keys to move between extinguishant area.
- Press the ✓ key to change between values – Solenoid/One Metron/Two Metron
- Press return  key again
- The **LEARN PANEL** sub-menu will display a list containing all 16 RSUs and show if they are connected or not, using the P-BUS, indicated by **PRESENT** or **NOT PRESENT**:  
**-P-BUS-**  
1: 1st RSU: PRESENT/NOT PRESENT  
2: 2nd RSU: PRESENT/NOT PRESENT  
3: 3rd RSU: PRESENT/NOT PRESENT  
to  
14: 14th RSU: PRESENT/NOT PRESENT  
15: 15th RSU: PRESENT/NOT PRESENT  
16: 16th RSU: PRESENT/NOT PRESENT
- Press the return  key to finally accept. A short acknowledgement sound will be present.

**Note:** The status of the RSUs may be changed, using the Up/Down arrow keys and the ✓ key to change between PRESENT or NOT PRESENT. However, any differences between detected devices and changes made by user, will result in a System Fault condition. The General Fault and System Fault status LEDs will be illuminated pulsing, with an accompanying fault tone from the internal buzzer. Additionally, on return to the Title screen, a FAULT display will list the applicable faults. This condition will require the panel to be re-configured to clear.



## Set Common Output for HOLD & ABORT

It is possible to set any of the outputs for use as a common output indication, to show activation of HOLD and ABORT functions for both Single and Dual flood zone Panels. A Sounder or Relay output can be used to provide this common indication.

**NOTE:** For dual flood zone panels, it is an EN 12094-1 requirement that a common output is used to indicate HOLD and ABORT activation from either flood zone area.

To set a common output for HOLD and ABORT functions:

- Turn **Activate Controls** key clockwise to **On**, or use the keypad to enter Authorised User (Access level 2) code 1111:
  - Press ✓ key
  - Use Up/Down arrow keys to increase/decrease the number value
  - Use Left/Right arrow keys to move to the next digit in the 4-digit sequence
  - When all 4 digits have been set to the code 1111, press the ✓ key again
- The Main Menu will become available for operation
- On the **Main Menu**, use Left/Right arrow keys to move cursor to **CONFIG** menu icon
- Press ✓ key to select **CONFIG** menu. The digital display will show the following message:  
**Enter Level 3 Access Code**
- Use the keypad to enter code 3333:
  - Press ✓ key
  - Use the Up/Down arrow keys to increase/decrease the number value
  - Use the Left/Right arrow keys to move to the next digit in the 4-digit sequence
  - When all 4 digits have been set to the code 3333 press ✓ key once again. The Access level 3 menu will become available for operation.
- On the **CONFIG** Menu, use Left/Right arrow keys to move the cursor to highlight **Devices** option and then press ✓ key to gain access to it.
- On the **CONFIG Devices** sub-menu, use left/right arrow keys to select either **SOUNDER** or **RELAY Menu**, depending on which type of output is to be used for common HOLD or ABORT indication:
  - **SOUNDER:** With the cursor over the **SOUNDER Menu** press ✓ button.
  - Use Left/Right arrow keys to toggle between the various Sounders
  - Use Up/Down arrow keys to select either:
    - option 12 for **ABORT** or
    - option 13 for **HOLD**.
  - **RELAY:** With the cursor over the **RELAY Menu** press ✓ button.
  - Use Left/Right arrow keys to toggle between the various Relays
  - Use Up/Down arrow keys to select either:
    - option 6 for **ABORT** or
    - option 7 for **HOLD**.
- Once required output and option have been selected, press ✓ button to change displayed setting from **NO** (de-selected) to **YES** (selected for activation). Further presses of ✓ button will toggle between these two states.

- When the required changes are completed, press return  button to return to **DEVICES** Menu. A short sequence of buzzer beeps will indicate that changes have been stored in memory.
- To go back to the main logo screen, press the return  button and the ✓ button as required.

## User Menu

Accessible from the **Main Menu** (Access level 2), the **User** menu and its subsequent sub-menus, are used to set-up the panel ready for configuration. The sub-menus available are:

- User
  - AUTO/MANUAL MODE
  - DISABLE
  - SET TIME & DATE
    - Time & Date
    - Set DST
  - LAMP TEST
  - CONTRAST
  - BUZZER

To access the Main Menu:

- Turn **Activate Controls** key to **On**
- or
- Use the keypad to enter code **1111**:
    - Press ✓ button
    - Use up/down arrow keys to increase/decrease the number value
    - Use left/right arrow keys to move to the next digit in the four-digit sequence
    - When all four digits are set to the code 1111, press ✓ button
    - The **Main Menu** will become available for operation.

**Note:** Access level 2 Menu will deactivate after 30 sec if not used.

### User Menu: AUTO/MANUAL MODE Menu

Used to select the operational mode between Auto/Manual mode and Manual Only mode (as an alternative to using the Select Mode key switch):

- From the **Main Menu**, use left/right arrow keys to move cursor box to **User** menu icon.
- Press ✓ button to select the User menu.
- Under **User Menu**, use left/right arrow keys to move cursor to the **AUTO MAN** sub-menu icon. Press ✓ button to open the **AUTO/MANUAL MODE Menu**:

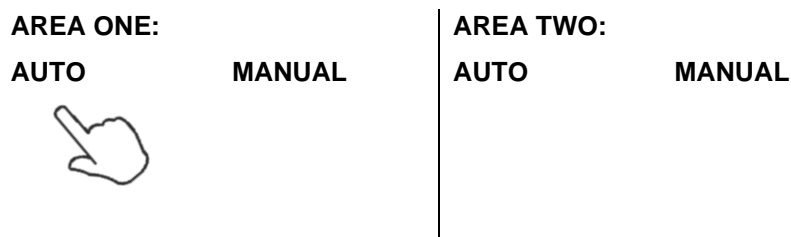

- The cursor will indicate current setting (AUTO or MANUAL).
- Use left/right arrow keys to move cursor to required setting and then press ✓ button.
- Press return  key when setting is completed.

- To go back to the main logo screen, press the return  key and the ✓ button, as required.

On selection of MANUAL mode, the Manual Only LED will be illuminated and the display shows:

**OTHER**                      **A00 F00 D00 O01**  
**1: MANUAL MODE ACTIVE**

### User Menu: DISABLE

To enable/disable outputs, devices and zones:

- From the **Main Menu**, use left/right arrow keys to move cursor box to **User** menu icon.
- Press ✓ button to select the **User** menu.
- Under **User** Menu, use left/right arrow keys to move cursor to the **DISABLE** sub-menu icon.
- Press ✓ button to select the **DISABLE** sub-menu.
- Under **DISABLE** sub-menu, the following options will be displayed:

**-GENERAL-**

- 1: SOUNDERS: ENABLED / DISABLED**
- 2: FIRE Relay: ENABLED / DISABLED**
- 3: FARE OUTPUT: ENABLED / DISABLED**
- 4: FAULT Relay: ENABLED / DISABLED**
- 5: FFRE OUTPUT: ENABLED / DISABLED**

**-GAS AREA ONE-**

- 6: Zone ONE: ENABLED / DISABLED**
- 7: Zone TWO: ENABLED / DISABLED**
- 8: Zone THREE: ENABLED / DISABLED**
- 9: EXTRACT Relay: ENABLED / DISABLED**
- 10: FIRST Stage Relay: ENABLED / DISABLED**
- 11: SECOND Stage Relay: ENABLED / DISABLED**
- 12: EXT-OP: ENABLED / DISABLED**
- 13: MAN RELEASE INPUT: ENABLED / DISABLED**
- 14: FLOW SWITCH INPUT: ENABLED / DISABLED**
- 15: LOW PRESSURE INPUT: ENABLED / DISABLED**
- 16: HOLD INPUT: ENABLED / DISABLED**
- 17: ABORT INPUT: ENABLED / DISABLED**
- 18: AUTO MAN INPUT: ENABLED / DISABLED**
- 19: LOCAL FIRE Relay: ENABLED / DISABLED**

**-GAS AREA TWO-**

- 20: Zone FOUR: ENABLED / DISABLED**
- 21: Zone FIVE: ENABLED / DISABLED**
- 22: Zone SIX: ENABLED / DISABLED**
- 23: EXTRACT Relay: ENABLED / DISABLED**
- 24: FIRST Stage Relay: ENABLED / DISABLED**
- 25: SECOND Stage Relay: ENABLED / DISABLED**

- 26: EXT-OP: ENABLED / DISABLED
- 27: MAN RELEASE INPUT: ENABLED / DISABLED
- 28: FLOW SWITCH INPUT: ENABLED / DISABLED
- 29: LOW PRESSURE INPUT: ENABLED / DISABLED
- 30: HOLD INPUT: ENABLED / DISABLED
- 31: ABORT INPUT: ENABLED / DISABLED
- 32: AUTO MAN INPUT: ENABLED / DISABLED
- 33: LOCAL FIRE Relay: ENABLED / DISABLED

- Use the Up/Down arrow keys to navigate between options.
- Press ✓ key to toggle between **ENABLED** or **DISABLED**.

**Note:** If any of these options are set to **DISABLED**, the amber **Disablement** LED will be illuminated as steady. If the **SOUNDERS** option is set to **DISABLED**, the amber **Sounder Status** LED will also be illuminated.

- When finished, press return ↵ key to accept the changes and return to **DISABLE** menu. A short acknowledgement sound will be present.
- Press the return ↵ key to return to User menu.

## User Menu: Time & Date

The **Time&Date** and **Set DST** sub-menus are used to set the system clock and the local Daylight Savings Time:

### Time&Date Menu: Time&Date

To set the system Time&Date:

- On the **Main Menu**, use Left/Right arrow keys to move cursor box to **User** menu
- Press ✓ key to select the **User** menu.
- Under **User** menu highlight the **Time&Date** option and press ✓ key to select it.
- On the **User Time&Date** sub-menu, highlight the **Time&Date** option and press ✓ key to access it.
- Adjust the time and date as required, using the Up/Down and Left/Right arrow keys.
- Press return ↵ key once to return to **Time&Date** menu.

### Time & Date Menu: Set DST

To set the start and end of local Daylight Savings Time on the system:

- On the **Main Menu**, use Left/Right arrow keys to move cursor box to **User** menu
- Press ✓ key to select the **User** menu.
- Under **User** menu highlight the **Time&Date** option and press ✓ key to select it.
- On the **User Time&Date** sub-menu, highlight **Set DST** option and press ✓ key to access it.



- Under the **Set DayLight Savings** sub-menu, the following options are displayed:
  - Set DayLight Savings Menu**
  - Starts: LAST Sunday MAR**
  - Ends: LAST Sunday OCT**
  - Auto Update DayLight Savings: YES/NO**
  - DST: ACTIVE/INACTIVE**
- To change the **Set DayLight Savings Menu** sub-menu options, to match local start and end of DST:
  - Use Left/Right arrow keys to move between the various fields (indicated by underline cursor). Use Up/Down arrow keys to toggle to the required setting for each field:
    - **Starts: LAST/1<sup>st</sup>/2<sup>nd</sup>/3<sup>rd</sup>/4<sup>th</sup> Monday – Sunday JAN – DEC** - adjust the date, to show when the local Day Light Savings time begins (e.g. – **Starts: Last Sunday MAY**)
    - **Ends: LAST/1<sup>st</sup>/2<sup>nd</sup>/3<sup>rd</sup>/4<sup>th</sup> Monday – Sunday JAN – DEC** - adjust the date, to show when the local Day Light Savings time ends (e.g. – **Ends: 4th Tuesday OCT**)
    - **Auto Update DayLight Savings: YES/NO** – adjust to turn on or off the automatic switching of the system clock forward by 1 hour to match local DST
    - **DST: ACTIVE / IN-ACTIVE** – not amendable, automatically shows the current DST state dependent on the above settings.
- Press return  key once to return to **Time&Date** menu.

## User Menu: LAMP TEST

To test the panel LCD display and warning LEDs:

- On the **Main Menu**, use Left/Right arrow keys to move cursor box to **User** menu
- Press ✓ key to select the **User** menu.
- Under **User** menu highlight the **Lamp Test** option, and then press ✓ key to select it.
- This action will enable the lamp test mode: the digital display will go off, and all LEDs on the front fascia will illuminate in sequence, along with main screen pixels. The internal buzzer will sound a long acknowledgement tone.
- After a few seconds the LCD digital display screen will turn back on (displaying the **User Menu**), after all LEDs have extinguished and the long acknowledgement sound has stopped.
- Press the ✓ key to return to the **Main Menu**.

## User Menu: Contrast

To set the LCD screen contrast and backlight, operate the **Contrast** menu:

- On the **Main Menu**, use Left/Right arrow keys to move cursor box to **User** menu
- Press ✓ key to select the **User** menu.
- Under **User Menu** highlight the **Contrast** option, and then press ✓ key to select it.
- Under the **Contrast** sub-menu, the two following options will be available:
  - **Contrast**: use the left and right arrow keys to adjust the value
  - **BACKLIGHT**: using the up and down arrow keys, one of the following values can be set: **MIN**, **HALF**, and **MAX**
- Press return  key to return to **User** menu. A short acknowledgement sound will be present.

## User Menu: BUZZER

To set the volume for the panel internal buzzer, operate the **BUZZER** menu:

- On the **Main Menu**, use Left/Right arrow keys to move cursor box to **User** menu
- Press ✓ key to select the **User** menu.
- Under **User Menu**, highlight the **BUZZER** option and then press ✓ key to select it.
- Under **BUZZER Menu** the following option will be available:  
**VOLUME**
- Use Left/Right arrow keys to adjust the buzzer volume
- Press return ↵ key to return to **User** Menu. A short acknowledgement sound will be present.

User Menu Breakdown

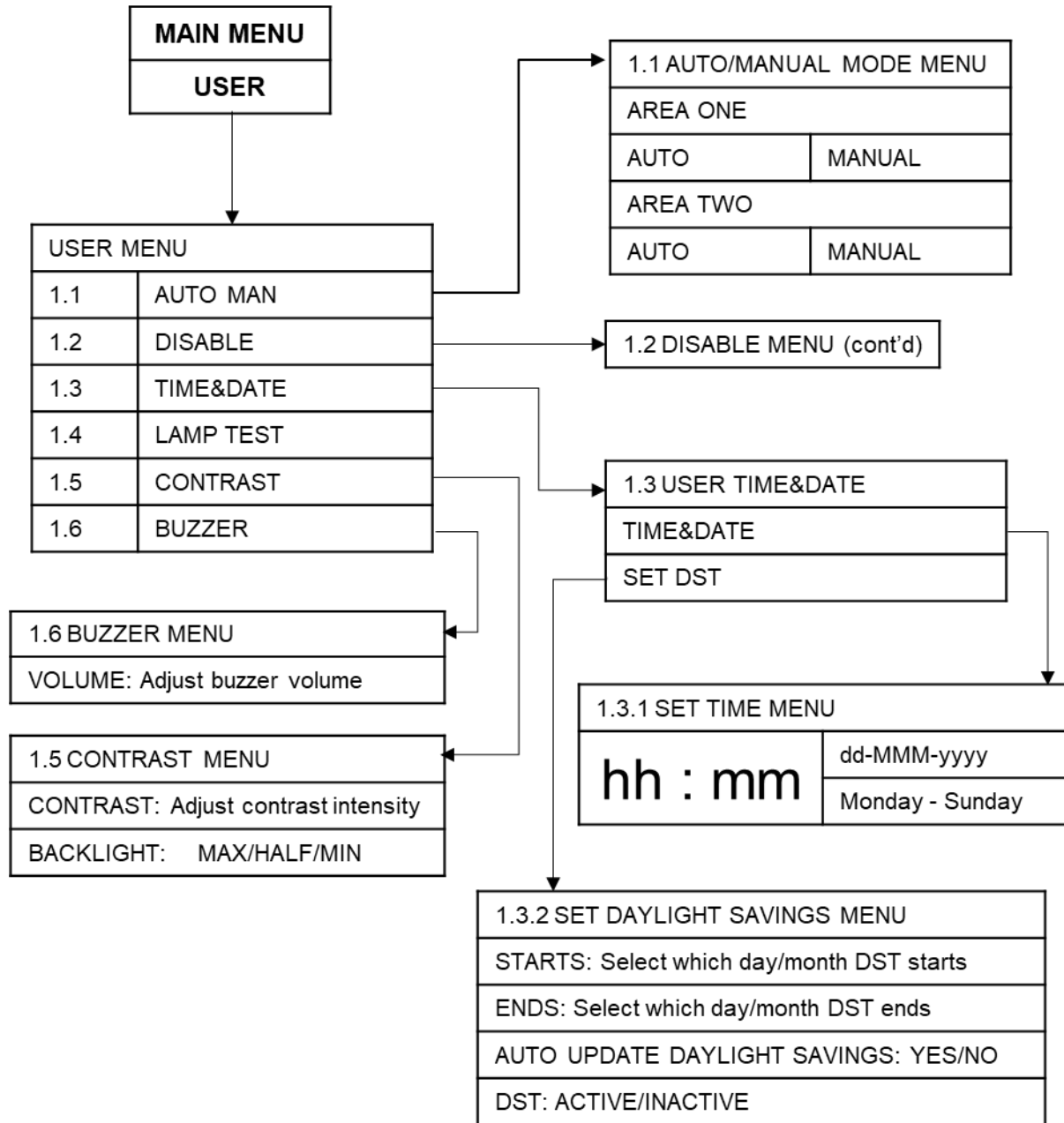

1.2 DISABLE (cont'd)

1.2 DISABLE MENU
-GENERAL-
1: SOUNDERS: ENABLED/DISABLED
2: FIRE RELAY: ENABLED/DISABLED
3: FARE RELAY: ENABLED/DISABLED
4: FAULT RELAY: ENABLED/DISABLED
5: FFRE OUTPUT: ENABLED/DISABLED
-GAS AREA ONE-
6: ZONE ONE: ENABLED/DISABLED
7: ZONE TWO: ENABLED/DISABLED
8: ZONE THREE: ENABLED/DISABLED
9: EXTRACT RELAY: ENABLED/DISABLED
10: FIRST Stage Relay: ENABLED / DISABLED
11: SECOND Stage Relay: ENABLED / DISABLED
12: EXT-OP: ENABLED / DISABLED
13: MAN RELEASE INPUT: ENABLED / DISABLED
14: FLOW SWITCH INPUT: ENABLED / DISABLED
15: LOW PRESSURE INPUT: ENABLED / DISABLED
16: HOLD INPUT: ENABLED / DISABLED
17: ABORT INPUT: ENABLED / DISABLED
18: AUTO MAN INPUT: ENABLED / DISABLED
19: LOCAL FIRE Relay: ENABLED / DISABLED
-GAS AREA TWO-
20: Zone FOUR: ENABLED / DISABLED
21: Zone FIVE: ENABLED / DISABLED
22: Zone SIX: ENABLED / DISABLED
23: EXTRACT Relay: ENABLED / DISABLED
24: FIRST Stage Relay: ENABLED / DISABLED
25: SECOND Stage Relay: ENABLED / DISABLED
26: EXT-OP: ENABLED / DISABLED
27: MAN RELEASE INPUT: ENABLED / DISABLED
28: FLOW SWITCH INPUT: ENABLED / DISABLED
29: LOW PRESSURE INPUT: ENABLED / DISABLED
30: HOLD INPUT: ENABLED / DISABLED
31: ABORT INPUT: ENABLED / DISABLED
32: AUTO MAN INPUT: ENABLED / DISABLED
33: LOCAL FIRE Relay: ENABLED / DISABLED

## CONFIG Menu

Accessible from the **Main Menu** (Access level 2); the **CONFIG** Menu (Access level 3), and its subsequent sub-menus, are used to configure the panel and its attached devices. The sub-menus available are:

- CONFIG
  - PANEL
    - LEARN
    - OPTIONS
    - DEFAULT
    - PASSWORD
  - GAS Card
  - Devices
    - Zones
    - SOUNDERS
    - RELAYS
  - P-BUS
  - PSU

To access the **CONFIG** menu:

- Turn **Activate Controls** key clockwise to **On**
- or
- Use the keypad to enter Authorised User (Access level 2) code 1111:
    - Press ✓ key
    - Use Up/Down arrow keys to increase/decrease the number value
    - Use Left/Right arrow keys to move to the next digit in the 4-digit sequence
    - When all 4 digits have been set to the code 1111, press the ✓ key again
    - The **Main Menu** will become available for operation

**Note:** Access level 2 Menu will deactivate after 30 sec if not used.

- On the **Main Menu**, use Left/Right arrow keys to move cursor to **CONFIG** menu icon
  - Press ✓ key to select **CONFIG** menu. The digital display will show the following message:  
**Enter Level 3 Access Code**
  - Use the keypad to enter code 3333:
    - Press ✓ key
    - Use the Up/Down arrow keys to increase/decrease the number value
    - Use the Left/Right arrow keys to move to the next digit in the 4-digit sequence
    - When all 4 digits have been set to the code 3333 press ✓ key once again. The Access level 3 menu will become available for operation.

## CONFIG Menu: PANEL

Under the **PANEL** sub-menu, the following sub-menus are available to configure the panel controls and outputs:

- LEARN
- OPTIONS
- SET DEFAULT PARAMETERS
- SET PASSWORDS

### CONFIG PANEL Menu: LEARN

To set the system to learn what internal cards, external devices and RSUs are connected, access the **LEARN PANEL** sub-menu:

- On the **CONFIG Menu**, highlight **PANEL** option and then press **✓** key to gain access to it.
- Next highlight the **LEARN** option, under the **CONFIG PANEL** menu, and press **✓** key to select it.
- The system will perform a learning routine, in order to acknowledge the Internal Cards installed, the External Devices connected to it, and the P-BUS (Peripheral BUS, which is achieved using a RS485 network) connection. The following information will be displayed in turn, each accompanied by a progress bar:
  - **LEARNING INTERNAL CARDS:**
  - **LEARNING EXTINGUISHANT:**
  - **LEARNING P-BUS:**
- On completion of the learning routine, the **LEARN PANEL** sub-menu will display all the options that were found available:
  - **INTERNAL CARDS:** The **LEARN PANEL** menu will display the internal cards found connected, or not, indicated by **YES** or **NO**:
    - INTERNAL CARDS-
    - 1: PSU Card: YES/NO
    - 2: Gas Card ONE: YES/NO
    - 3: Gas Card TWO: YES/NO
    - 4: AREA TWO FASCIA: YES/NO
    - 5: Relay ONE: YES/NO
    - 6: Relay TWO: YES/NO
  - Press return  key to accept.
  - **EXTINGUISHANT OUTPUT:** The **LEARN PANEL** menu will display the extinguishant release options:
    - EXTINGUISHANT OUTPUT-
    - 1: AREA 1: SOLENOID/ONE METRON/TWO METRON/THREE METRON/NOT PRESENT
    - 2: AREA 2: SOLENOID/ONE METRON/TWO METRON/THREE METRON/NOT PRESENT
  - Use the Up/Down arrow keys to move between extinguishant area.
  - Press the **✓** key to change between values – **Solenoid/One Metron/Two Metron/Three Metron/Not Present**.

- Press return  key again
- **P-BUS:** The **LEARN PANEL** sub-menu will display a list containing all 16 RSUs and show if they are connected or not, using the P-BUS, indicated by the Gas area the RSU is connected to, or **NOT PRESENT**:

**-P-BUS-**

**1: FIRST RSU: GAS AREA ONE/GAS AREA TWO/NOT PRESENT**

**2: SECOND RSU: GAS AREA ONE/GAS AREA TWO/NOT PRESENT**



**3: THIRD RSU: GAS AREA ONE/GAS AREA TWO/NOT PRESENT**

to

**14: FOURTEENTH RSU: GAS AREA ONE/GAS AREA TWO/NOT PRESENT**

**15: FIFTEENTH RSU: GAS AREA ONE/GAS AREA TWO/NOT PRESENT**





**16: SIXTEENTH: GAS AREA ONE/GAS AREA TWO/NOT PRESENT**

- For each of the RSUs fitted, configure to show which Gas Area they are installed in:
  - Use the Up/Down arrow keys to select each RSU to be configured
  - Press the enter  key to toggle through the options, **GAS AREA ONE/GAS AREA TWO/NOT PRESENT**,
- Press the return  key to finally accept. A short acknowledgement sound will be present.

**Note:** The status of the RSUs may be changed, using the Up/Down arrow keys and the  key to change between **GAS AREA ONE**, **GAS AREA TWO** or **NOT PRESENT**. However, any differences between detected devices and changes made by user, will result in a System Fault condition. The **General Fault** and **System Fault** status LEDs will be illuminated pulsing, with an accompanying fault tone from the internal buzzer. Additionally, on return to the Title screen, a **FAULT** display will list the applicable faults. This condition will require the panel to be re-configured to clear.



## CONFIG PANEL Menu: OPTIONS

To configure the panel sounder options, access the **OPTIONS** menu:

- On the **CONFIG Menu**, highlight **PANEL** option and then press  key to gain access to it.
- Next highlight the **OPTIONS** icon, under the **CONFIG PANEL** menu and press  key to select it.
- The information available under **PANEL OPTIONS** menu will be presented as follows (use the up/down arrows key to navigate between following settings):
  - 1: ZONES RESOUND 2ND ALARM: YES/NO**
  - 2: Sounder ONE FARE: YES/NO**
  - 3: Sounder TWO FFRE: YES/NO**
  - 4: RESET INHIBIT TIME (Min): nnnn**
    - Use the Up/Down arrow keys to move between options 1 to 4
- For options 1 to 3, press enter  key to toggle between **YES** or **NO**, as required.
- For option 4, press enter  key to enable changes, then use Up/Down arrow keys to set the time the sounders activation is to be inhibited by (up to a maximum of 30 minutes). Press the  key to exit **RESET INHIBIT TIME** adjustment function.

**Note:** If **SOUNDER ONE FARE** and/or **SOUNDER TWO FFRE** are set to **YES**, their status (**NORMAL/ACTIVE**) will be displayed on the LCD screen title display, and in place of the event counts (**A nn F nn D nn O nn**) on any of the **EVENT** reports (**ALARM, FAULT, DISABLE** and **OTHER**).

**Note:** When a circuit goes into Fire Alarm, option 4 sets a time delay of up to 30 minutes before the sounders and extinguishant release are activated. This is to protect against possible false alarms. This option is overridden if a second circuit goes into Alarm, or the extinguishant is released manually.

- Press return  key to exit Menu. A short sequence of buzzer beeps will indicate the changes have been stored in memory.
- Further presses of return  key will bring back to Title screen.

### CONFIG PANEL Menu: DEFAULT

To return the panel to its factory default setting, access the **DEFAULT** menu.

- On the CONFIG Menu, highlight **PANEL** option and then press ✓ key to gain access to it.
- Next highlight the **DEFAULT** icon, under the **CONFIG PANEL** menu and press ✓ key to select it.
- The following information will be displayed on the digital monitor:

**ARE YOU SURE?**

Set Panel Defaults?



- Use the Left/Right arrows key to choose between **YES** or **NO** options and then press the ✓ key in order to enable your action.
- If **NO** value has been selected, then the system will return to **CONFIG PANEL** Menu and all the current settings will be maintained.
- If **YES** is selected, then all current settings will be overwritten, and the system will return to original factory settings. A short acknowledgement sound will be present.

**Caution is recommended before choosing the YES value for the DEFAULT option! Choosing this option will remove ALL configuration that has been set and will return the panel to its factory default settings.**

- Next press the return  key once to return to **CONFIG PANEL** Menu. A short acknowledgement sound will be present.

### CONFIG PANEL Menu: PASSWORD

To set the 4-digit access codes, access the **Password** menu:

- On the **CONFIG Menu**, highlight **PANEL** option and then press ✓ key to gain access to it.
- Highlight the **Password** option under the **CONFIG PANEL** menu and press ✓ key again.
- The **Set Password Menu** will be presented as follows:

**OLD User Password: 1111**                      **Back**  
**User Password: 0000**                        **Confirm**

- Use the Up/Down arrow keys to increase/decrease the number value
- Use the Left/Right arrow keys to move to the next digit in the 4-digit sequence
- When all 4 digits have been set to the required new code press ✓ key once again.
- Press the return  key once to return to **Panel** menu.



## CONFIG Menu: GAS CARD

To configure the Gas Card:

- On the **CONFIG Menu**, highlight **PANEL** option and then press ✓ key to gain access to it.
- Highlight **GAS CARD** option and then press ✓ key in order to gain access to it.
- The Gas Card information will be displayed as follows:
  - CONFIG GAS CardGAS AREA ONE/TWO**
  - 1: EXTINGUISH DELAY (Secs) : nnnn**
  - 2: EXTINGUISH DUR (Secs) : nnnn**
  - 3: EXTRACT Time (Min) : nnnn**
  - 4: FLOODING Time (Secs) : nnnn**
  - 5: EXTRACT OUTPUT: AUTO/MANUAL/NO EXTRACT**
  - 6: FLOW SWITCH PRESENT: NO/YES**
  - 7: PRESSURE SWITCH: NORMAL OPEN/CLOSED**
  - 8: MANUAL RELEASE MODE: DELAYED/IMMEDIATE**
  - CONTRIBUTORY ALARM-**
  - 9: Zone ONE: YES/NO**
  - 10: Zone TWO: YES/NO**
  - 11: Zone THREE: YES/NO**
  - 12: Zone FOUR: YES/NO**
  - 13: Zone FIVE: YES/NO**
  - 14: Zone SIX: YES/NO**
  - 15: CONTRIBUTORY COUNT: ONE/TWO/THREE/FOUR**
- Configure the various options for the Gas Card(s), as follows:
  - Use Left/Right arrow keys to toggle between Gas Areas **ONE** and **TWO**
  - Use Up/Down arrow keys to select required option
  - For options 1 to 4, press ✓ key to activate time change function
  - Use Up/Down arrow keys to adjust indicated time (n) to required time (within limits available)
  - Press ✓ key to de-activate time change function
  - Up/Down arrow keys now return to selecting required option
  - For options 5 to 15, press ✓ key to toggle between the indicated states.

**Note:** for single Flood Zone Panels, access to options 12 to14 (zones 4 to 6) in this menu will be blocked
- When selections are completed press return  key to return to Title screen. A short sequence of buzzer beeps will indicate changes have been stored in memory.

## CONFIG Menu: DEVICES

Under the Devices sub-menu, the following sub-menus are available to configure the external devices and outputs:

- ZONES
- SOUNDERS
- Relay

### CONFIG DEVICES Menu: Zones

To configure the options for the Flood Zones/Detection Zones:

- On the **CONFIG Menu**, highlight **DEVICES** option and then press ✓ key to gain access to it.
- Next, on the **CONFIG Devices** sub-menu, highlight the **Zones** option press the ✓ key again.
- The **CONFIG ZONES** sub-menu will open. The **CONFIG ZONES** information will be displayed, as follows:

**CONFIG ZONES** <Zone 01 – 03> (single flood zone) or <Zone 01 – 06> (dual flood zone)

**1: LATCH FIRE: YES/NO**



**2: S/C TRIGGERS ALARM: YES/NO**

**3: INTRINS SAFE: YES/NO**

**4: PRIORITY ALARM: ENABLED/DISABLED**

**5: HEAD REMOVAL: ENABLED/DISABLED**

**6: Sounder DELAY: OFF/10 SEC/20 SEC/30 SEC/1 MIN/90 SEC/2 – 10 MIN**

- Use Up/Down arrow keys to select between the options.
- For options 1 – 5; press the ✓ key to toggle between the 2 states.
- On option 6 (**Sounder DELAY**); each press of the ✓ key will run through the time settings available.
- When finished press return  key to return to **CONFIG Devices** menu. A short sequence of buzzer beeps will indicate the changes have been stored in memory.
- Further presses of return  key will exit back to Title screen.

### CONFIG DEVICES Menu: SOUNDERS

To configure the Sounders outputs:

- On the **CONFIG Menu**, use Left/Right arrow keys to move the cursor to highlight **Devices** option and then press ✓ key to gain access to it.
- On the **CONFIG Devices** sub-menu, highlight the **SOUNDERS** option and press the ✓ key again.

- The information available under **SOUNDERS** menu will be presented as follows:

**SOUNDERS <PSU SNDR ONE/PSU SNDR TWO/GAS AREA ONE STAGE 1/GAS AREA ONE STAGE 2/GAS AREA TWO STAGE 1/GAS AREA TWO STAGE 2>**

**-PRE-ACTIVATED Stage-**

**1: Sounder: CONTINUOUS / PULSING / OFF**

**-ACTIVATED Stage-**

**2: Sounder: CONTINUOUS / PULSING / OFF**

**-RELEASED Stage-**

**3: Sounder: CONTINUOUS / PULSING / OFF**

**-EXTRACT Stage-**

**4: Sounder: CONTINUOUS / PULSING / OFF**

**-NON-CONTRIB ALARM-**

**5: Sounder: CONTINUOUS / PULSING / OFF**

**-OTHER OUTPUTS-**

**6: IN ALARM: CONTINUOUS / PULSING / OFF**

**7: IN ALERT: CONTINUOUS / PULSING / OFF**

**8: IN CLASS CHANGE: CONTINUOUS / PULSING / OFF**

**9: IN EVAC: CONTINUOUS / PULSING / OFF**

**10: IN DELAY: CONTINUOUS / PULSING / OFF**

**11: Sounder CAN BE SILENCED: YES / NO**

**12: Sounder ABORT OUTPUT: YES / NO**

**13: Sounder HOLD OUTPUT: YES / NO**

**Note:** Single Flood Zone Panels will have 4 Sounders (2 Common PSU Card Sounders and 2 Sounders for the Gas Card). Dual Flood Zone Panels will have 6 Sounders (2 Common PSU Card Sounders and 2 Sounders for each Gas Card fitted).

- Use Left/Right arrow keys to toggle between the various Sounders (**PSU SNDR ONE, PSU SNDR TWO, GAS AREA ONE STAGE 1, GAS AREA ONE STAGE 2**, etc.)
- Use Up/Down arrow keys to select required Sounder Output option.
- Once option selected, press the ✓ key to change indicated state.

**Note:** For options 1 to 10, each press of ✓ key will toggle between the 3 available states (**CONTINUOUS, PULSING** and **OFF**).

**Note:** For options 11 to 13, each press of ✓ key will toggle between **YES** and **NO**.

- When the required state for each of the options has been set, press the return ↵ key to return to **CONFIG Devices** sub-menu. A short sequence of buzzer beeps will indicate the changes have been stored in memory.
- Further presses of return ↵ key will exit back to Title screen.

## CONFIG DEVICES Menu: RELAYS

To configure the Relay outputs:

- On the **CONFIG Menu**, highlight **Devices** option and then press ✓ key to gain access to it.
- On the **CONFIG Devices** sub-menu, highlight the **Relay** option and press the ✓ key again.
- The information available under the **CONFIG Relay** sub-menu will be presented as follows:

**CONFIG Relay** <FIRE / FAULT / AREA ONE Stage ONE / AREA ONE Stage TWO / AREA ONE EXTRACT / AREA ONE LOCAL FIRE / AREA TWO Stage ONE / AREA TWO Stage TWO / AREA TWO EXTRACT / AREA TWO LOCAL FIRE>

1: GENERAL ALARM: CONTINUOUS / PULSING / OFF

2: PRE-ACTIVATED: CONTINUOUS / PULSING / OFF

3: ACTIVATED: CONTINUOUS / PULSING / OFF

4: RELEASED Stage: CONTINUOUS / PULSING / OFF

5: NON-CONTRIB ALARM: CONTINUOUS / PULSING / OFF

6: Relay ABORT OUTPUT: YES / NO

7: Relay HOLD OUTPUT: YES / NO

8: AREA 1 ALARM: YES / NO

9: AREA 2 ALARM: YES / NO

10: EVAC: CONTINUOUS / PULSING / OFF

11: FAULT: CONTINUOUS / PULSING / OFF

12: FAIL: YES / NO

13: EXTRACT AREA 1: YES / NO

14: EXTRACT AREA 2: YES / NO

**Note:** Single Flood Zone Panels will have 6 Relays (2 common Relays on the PSU Card – FIRE and FAULT – and 4 Relays for the Gas Card). Dual Flood Zone Panels will have 10 Relays (2 common Relays on the PSU Card – FIRE and FAULT - and 4 Relays on each Gas Card fitted).

- Use Left/Right arrow keys to toggle between the various Relays (**FIRE, FAULT, AREA ONE Stage ONE, AREA ONE Stage TWO**, etc.).
- Use Up/Down arrow keys to select required **Relay** Output option.
- Once selected, press the ✓ key to change indicated state.

**Note:** For options 1 to 5, 10 and 11, each press of ✓ key will toggle between the 3 available states (**CONTINUOUS, PULSING** and **OFF**).

**Note:** For options 6 to 9, 12 to 14 pressing the ✓ key will toggle between **YES** and **NO**.

- When finished, press the return ↵ key to return to **CONFIG Devices** Menu. A short sequence of buzzer beeps will indicate the changes have been stored in memory.
- Further presses of return ↵ key will exit back to Title screen.

## CONFIG Menu: P-BUS

To configure the P-BUS, access the **P-BUS** menu.

- From the **CONFIG** sub-menu, highlight **P-BUS** option and then press the ✓ key in order to gain access to it.
- The information available under **CONFIG P-BUS** will be presented as follows:  
**-P-BUS-**  
**1: FIRST RSU: GAS AREA ONE/GAS AREA TWO/NOT PRESENT**  
**2: SECOND RSU: GAS AREA ONE/GAS AREA TWO/NOT PRESENT**  
**3: THIRD RSU: GAS AREA ONE/GAS AREA TWO/NOT PRESENT**  
to  
**14: FOURTEENTH RSU: GAS AREA ONE/GAS AREA TWO/NOT PRESENT**  
**15: FIFTEENTH RSU: GAS AREA ONE/GAS AREA TWO/NOT PRESENT**  
**16: SIXTEENTH: GAS AREA ONE/GAS AREA TWO/NOT PRESENT**
- If, since the last panel LEARN routine, RSU(s) have been added to, or removed from, the P-BUS, their status can be changed manually:
  - Use the Up/Down arrow keys to select which RSUs are to be configured.
  - Press ✓ key to change between **GAS AREA ONE/GAS AREA TWO/NOT PRESENT**
  - Press the return  key once to return to **CONFIG Devices** menu. A short acknowledgement sound will be present.

**Note:** Any differences, between detected devices and changes made by user, will result in a General Fault condition. The **General Fault** status LED will be illuminated pulsing, with an accompanying fault tone from the internal buzzer. Additionally, on return to the Title screen, a **FAULT** display will list the applicable faults (i.e. '1: RSU RSU 01 OFFLINE'). This condition will require the panel to be re-configured to clear.

## CONFIG Menu: PSU

To configure Power Supply Unit settings, access the **CONFIG PSU** menu:

- From the **CONFIG** sub-menu, highlight **PSU** option and then press the ✓ key in order to gain access to it.
- The information available under **CONFIG PSU** menu will be presented as:  
**1: BATTERY MONITORING: YES/NO**  
**2: BATTERY HIGH-Z MONITORING: YES/NO**  
**3: CHARGE DURING ALARM: YES/NO**  
**4: EARTH FAULT MONITORING: YES/NO**  
**5: UPS MODE: YES/NO**
- Use the Up/Down arrow keys to navigate between options 1 – 5.
- Press ✓ key to change between **YES** or **NO** values, as required, for each option.

Next press the return  key to return to **CONFIG MENU**. A short acknowledgement sound will be present.

**CONFIG Menu Breakdown**

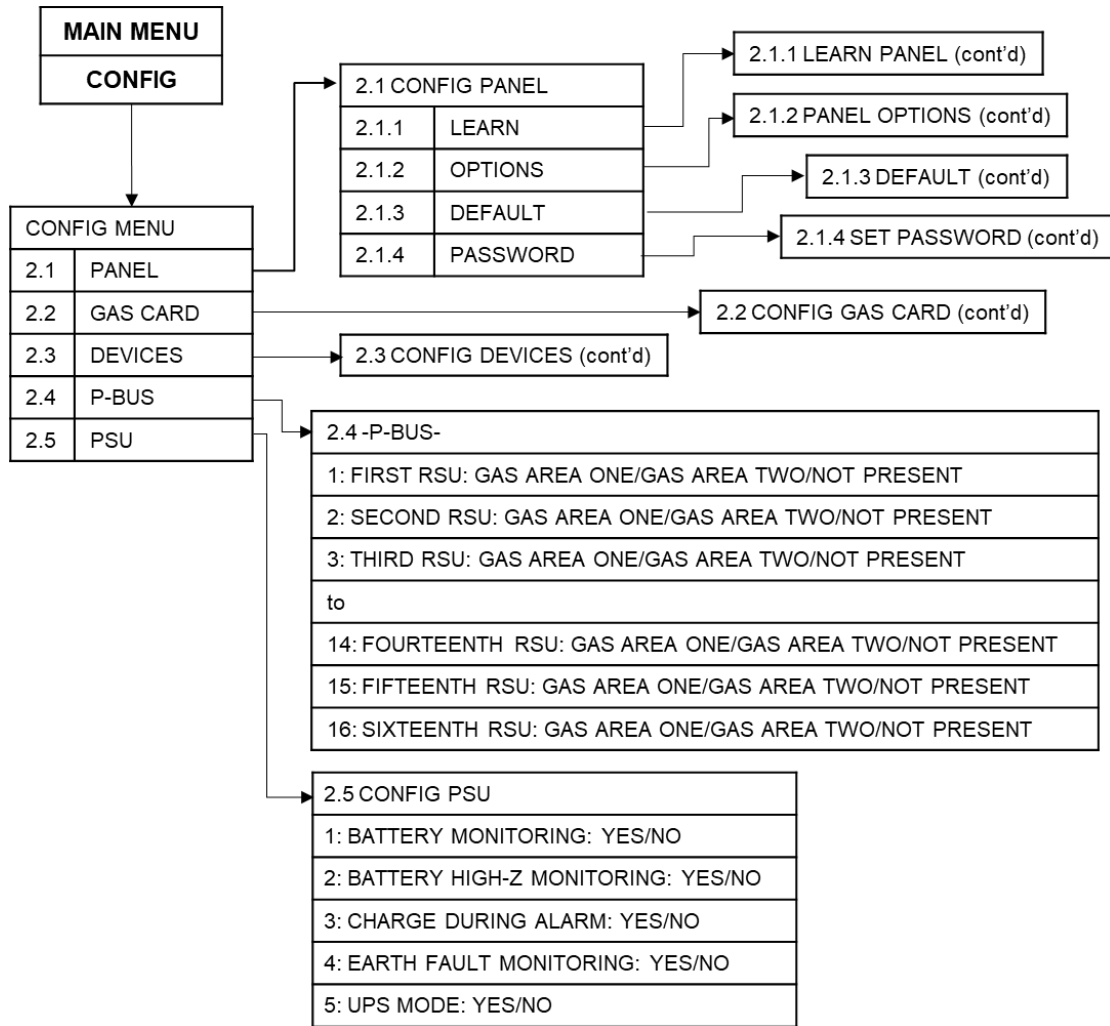

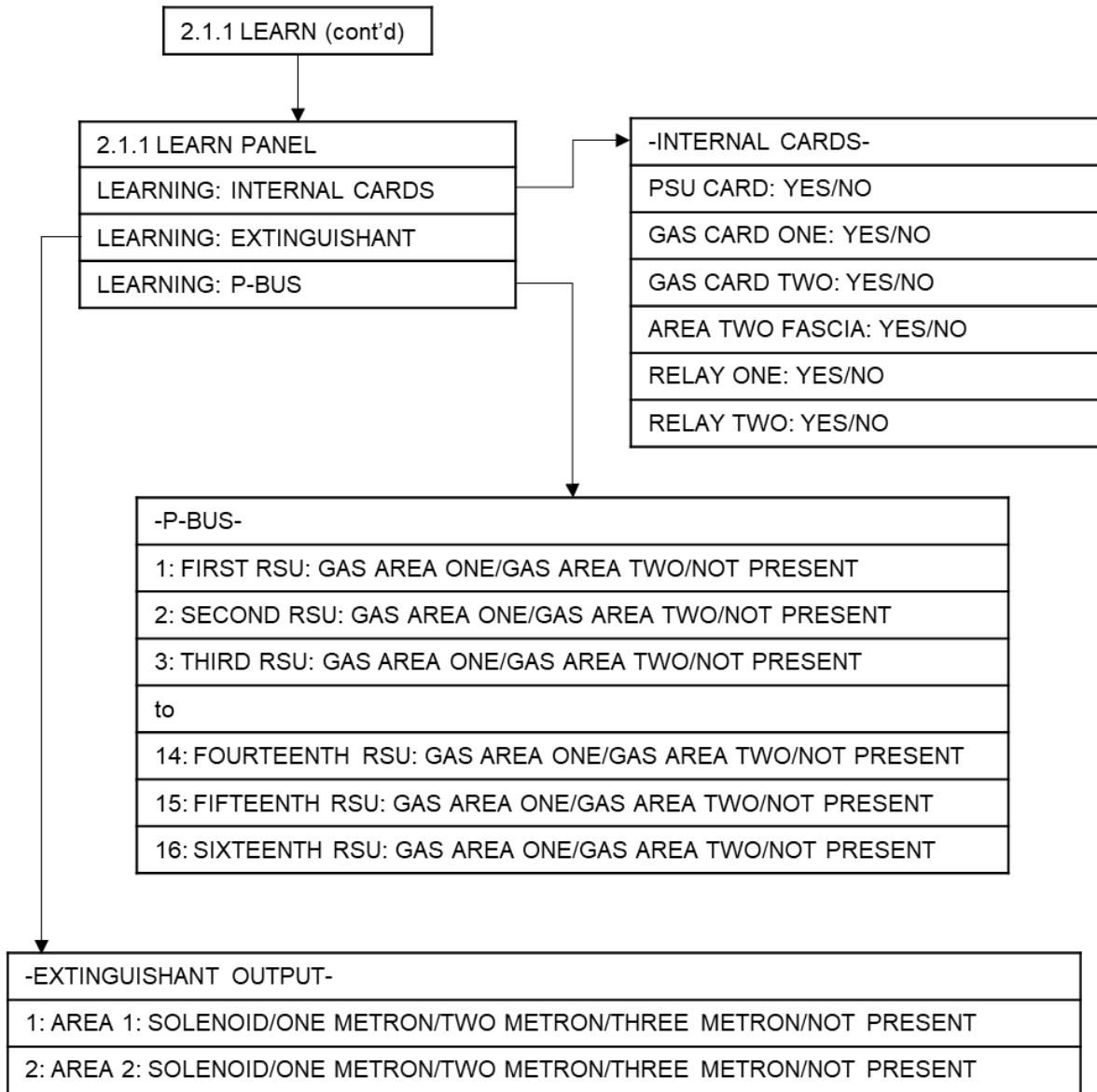

2.1.2 OPTIONS (cont'd)

2.1.2 PANEL OPTIONS	
1: ZONES RESOUND 2 <sup>ND</sup> ALARM: YES/NO	
2: SOUNDER ONE FARE: YES/NO	
3: SOUNDER TWO FFRE: YES/NO	
4: RESET INHIBIT TIME (Min): nnnn (0 – 30 Min)	

2.1.3 DEFAULT (cont'd)

2.1.3 DEFAULT	
ARE YOU SURE?	
SET PANEL DAEFAULTS	
YES	NO

2.1.4 PASSWORD (cont'd)

2.1.4 SET PASSWORD	
OLD USER PASSWORD: nnnn (1 – 9)	BACK
USER PASSWORD nnnn (1 – 9)	CONFIRM



2.2 GAS CARD (cont'd)



2.2 CONFIG GAS CARD	
CONFIG GAS CARD	GAS AREA ONE/TWO
1: EXTINGUISH DELAY (SECS): NNNN (0 – 60 SECS)	
2: EXTINGUISH DUR (SECS): NNNN (0 – 300 SECS)	
3: EXTRACT TIME (MIN): NNNN (1 – 90 MIN)	
4: FLOODING TIME (SECS): NNNN (60 – 1800 SECS)	
5: EXTRACT OUTPUT: AUTO/MANUAL/NO EXTRACT	
6: FLOW SWITCH PRESENT: YES/NO	
7: PRESSURE SWITCH: NORMAL OPEN/CLOSED	
8: MANUAL RELEASE MODE: IMMEDIATE/DELAYED	
-CONTRIBUTORY ALARM-	
9: ZONE ONE: YES/NO	
10: ZONE TWO: YES/NO	
11: ZONE THREE: YES/NO	
12: ZONE FOUR: YES/NO	
13: ZONE FIVE: YES/NO	
14: ZONE SIX: YES/NO	
15: CONTRIBUTORY COUNT: ONE/TWO/THREE/FOUR	

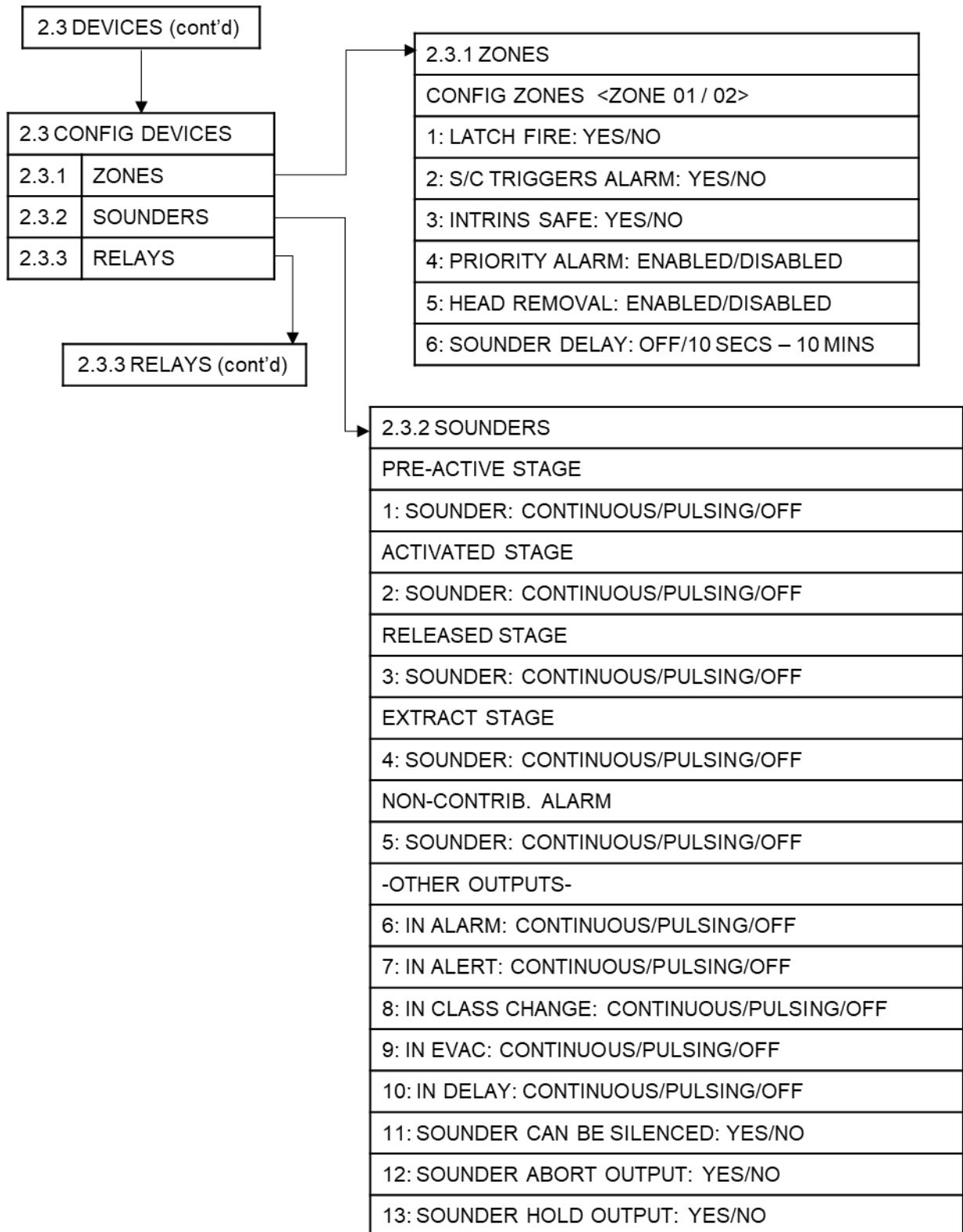

2.3.3 RELAYS (cont'd)

2.3.3 RELAYS
CONFIG RELAY <FIRE / FAULT / AREA ONE STAGE ONE / AREA ONE STAGE TWO / AREA ONE EXTRACT / AREA ONE LOCAL FIRE / AREA TWO STAGE ONE / AREA TWO STAGE TWO / AREA TWO EXTRACT / AREA TWO LOCAL FIRE>
1: GENERAL ALARM: CONTINUOUS/PULSING/OFF
2: PRE-ACTIVATED: CONTINUOUS/PULSING/OFF
3: ACTIVATED: CONTINUOUS/PULSING/OFF
4: RELEASED STAGE: CONTINUOUS/PULSING/OFF
5: NON-CONTRIB ALARM: CONTINUOUS/PULSING/OFF
6: RELAY ABORT OUTPUT: YES/NO
7: RELAY HOLD OUTPUT: YES/NO
8: AREA 1 ALARM: YES/NO
9: AREA 2 ALARM: YES/NO
10: EVAC: CONTINUOUS/PULSING/OFF
11: FAULT: CONTINUOUS/PULSING/OFF
12: FAIL SAFE: YES/NO
13: EXTRACT AREA 1: YES/NO
14: EXTRACT AREA 2: YES/NO

## CONTROL Menu

From the **Main Menu**, the **CONTROL** menu (Access level 3) option, and its sub-menus, is used to configure the extinguishant's release and extraction:

- **CONTROL**
  - **EXTRACT**
  - **FLOODING**
  - **DELAYS**

To access the **CONTROL** menu:

- Turn **Activate Controls** key clockwise to **On**, or use the keypad to enter Authorised User (Access level 2) code 1111:
  - Press ✓ key
  - Use Up/Down arrow keys to increase/decrease the number value
  - Use Left/Right arrow keys to move to the next digit in the 4-digit sequence
  - When all 4 digits have been set to the code 1111, press the ✓ key again
- The **Main Menu** will become available for operation
- On the **Main Menu**, use Left/Right arrow keys to move cursor to **CONTROL** menu icon
- Press ✓ key to select **CONTROL** menu. The digital display will show the following message:
 

**Enter Level 3 Access Code**
- Use the keypad to enter code 3333:
  - Press ✓ key
  - Use the Up/Down arrow keys to increase/decrease the number value
  - Use the Left/Right arrow keys to move to the next digit in the 4-digit sequence
  - When all 4 digits have been set to the code 3333 press ✓ key once again. The Access level 3 menu will become available for operation.

### Control Menu: EXTRACT

To configure the **EXTRACT** controls, access the **EXTRACT** menu:

- From the **CONTROL Menu**, highlight **EXTRACT** option and then press the ✓ key in order to gain access to it.
- The information available under **EXTRACT** Menu will be presented as follows:
 

**EXTRACT Menu                      GAS AREA ONE / TWO / BOTH**

**START EXTRACT**

**STOP EXTRACT**
- Use Left/Right arrow keys to toggle between the Gas Area options (**One**, **Two** or **Both**)
- Use the Up/Down arrow keys to navigate between them.
- Press the ✓ key to select required option.
- Press return ↵ key to return to **CONTROL Menu**, further presses of return ↵ key to return to logo screen.

## Control Menu: FLOODING

To configure the **FLOODING** controls, access the **FLOODING** menu.

- From the **CONTROL Menu**, highlight **FLOODING** option and then press the ✓ key in order to gain access to it, the following will be displayed:

### Enter Level 3 Access Code

- Use the keypad to enter code 3333:
  - Press ✓ key
  - Use the Up/Down arrow keys to increase/decrease the number value of the first digit in the 4-digit sequence.
  - Use the Left/Right arrow keys to move to the next digit in the 4-digit sequence
  - When all 4 digits have been set to the code 3333 press ✓ key once again.
- The **FLOODING** menu will be presented, as follows:

#### FLOODING

**AREA ONE:**

**STOP**

**STATE:**

**FLOODING / OFF**

**AREA TWO**

**STOP**

**STATE:**

**FLOODING / OFF**

- Use Left/Right arrow keys to move between Flood Zone Areas (dual flood zone panels only).
- Press the ✓ key to stop flooding time count (jumps to end of Flooding time count, when stopped).
- The indicated **STATE** on the screen will change from **FLOODING** to **OFF**.
- Press return ↵ key to return to **CONTROL Menu**, further pressing return ↵ key to return to Logo screen.

## Control Menu: DELAYS

To configure the system **DELAYS**, access the **DELAYS** menu:

- From the **CONTROL Menu**, highlight **DELAYS** option and then press the ✓ key in order to gain access to it.
- For Enabling of any set Zone Delays:
  - Use Left/Right arrow keys to move indicator between **OFF** and **ON**.
- Press return ↵ key to accept and return to **CONTROL Menu**, further pressing return ↵ key to return to Logo screen.

### CONTROL Menu Breakdown

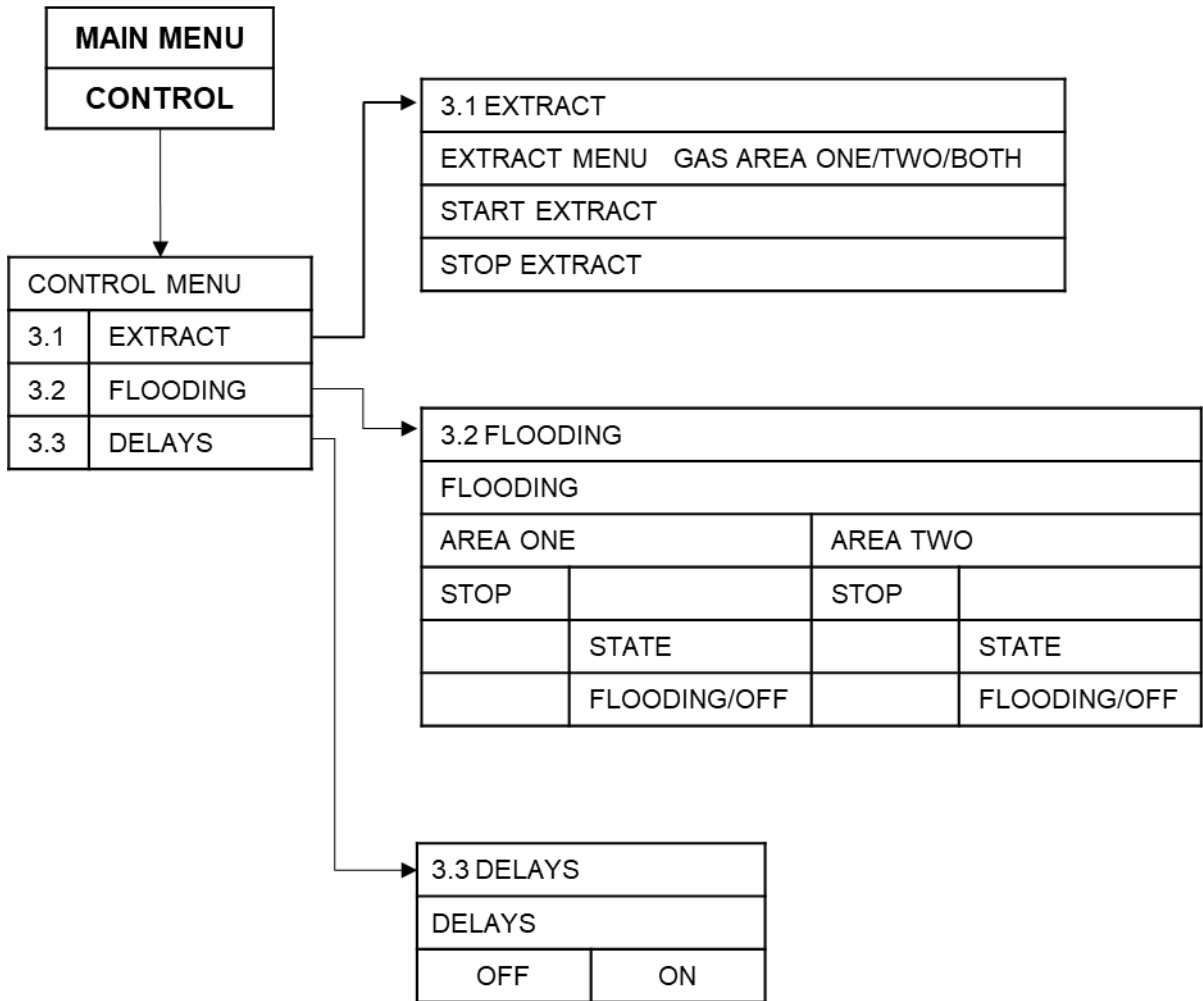

## Report Menu

From the Report Menu, accessible from the Main Menu, the following sub-menus are available:

- Report
  - ALARM
  - FAULT
  - DISABLE
  - OTHER
  - HISTORY
  - Versions
  - COUNTER
  - Gas Card
  - PSU Card
  - BATTERY

To access the **Report** Menu:

- Turn **Activate Controls** key clockwise to **On**
- or
- Use the keypad to enter Authorised User (Access level 2) code 1111:
    - Press ✓ key
    - Use Up/Down arrow keys to increase/decrease the number value
    - Use Left/Right arrow keys to move to the next digit in the 4-digit sequence
    - When all 4 digits have been set to the code 1111, press the ✓ key again
  - The **Main Menu** will become available for operation

### Report Menu: ALARM

From the **ALARM** sub-menu; the number of ALARM events, together with information on the Gas release status for the Gas Area(s), is displayed.

To get ALARM events information:

- On the **Main Menu**, use Left/Right arrow keys to move cursor to **Report** menu icon and press ✓ key to select.
- From the **Report Menu**, use Left/Right arrow keys to move cursor to select **ALARM** sub-menu. Press ✓ key to select.

- The number (n) of Alarm events will be displayed in the following manner:

**ALARM                                  A nn    F 00    D 00    O 00**

**List of detected alarms**

or

**ALARM                          FFRE : NORMAL/ACTIVE and/or FARE : NORMAL/ACTIVE**

**List of detected alarms**

(Displayed if Sounder One FARE and/or Sounder Two FFRE are selected to YES, under CONFIG : PANEL : OPTIONS, during configuration)

Where:

**A** means Alarm

**F** means Faults

**D** means Disablement

**O** means Other

- The status of the extinguishant release is also indicated. If a fire alarm occurs in a Detection Zone that has no effect on the extinguishant control, then the display shows **UNAFFECTED**.
- Press the return  key or ✓ key to return to the **Main Menu** display.

## Report Menu: FAULT

From the **FAULT** sub-menu; the number of **FAULT** events is displayed.

To get **FAULT** events information:

- On the **Main Menu**, use Left/Right arrow keys to move cursor to **Report** menu icon and press ✓ key to select.
- From the **Report Menu**, use Left/Right arrow keys to move cursor to select **FAULT** sub-menu. Press ✓ key to select.
- The number (n) of Fault events will be displayed in the following manner:

**FAULT                                  A 00    F nn    D 00    O 00**

**List of detected faults**

or

**FAULT                          FFRE : NORMAL/ACTIVE and/or FARE : NORMAL/ACTIVE**

**List of detected faults**

(Displayed if Sounder One FARE and/or Sounder Two FFRE are selected to YES, under CONFIG : PANEL : OPTIONS, during configuration)

Where:

**A** means Alarm

**F** means Faults

**D** means Disablement

**O** means Other

- Press the return  key or ✓ key to return to the **Main Menu** display.



## Report Menu: DISABLE

From the **DISABLE** sub-menu; the number of system disablements is displayed.

To get **DISABLE** events information:

- Turn **Activate Controls** key clockwise to **On**
- or
- Use the keypad to enter Authorised User (Access level 2) code 1111:
  - Press ✓ key
  - Use Up/Down arrow keys to increase/decrease the number value
  - Use Left/Right arrow keys to move to the next digit in the 4-digit sequence
  - When all 4 digits have been set to the code 1111, press the ✓ key again
- The **Main Menu** will become available for operation
- On the **Main Menu**, use Left/Right arrow keys to move cursor to **Report** menu icon and press ✓ key to select.
- From the **Report Menu**, use Left/Right arrow keys to move cursor to select **DISABLE** sub-menu. Press ✓ key to select.
  - The number (n) of Disablement events will be displayed in the following manner:

**DISABLE                                    A 00    F 00    D nn    O 00**

**List of detected disablements**

or

**DISABLE                                    FFRE : NORMAL/ACTIVE and/or FARE : NORMAL/ACTIVE**

**List of detected disablements**

(Displayed if Sounder One FARE and/or Sounder Two FFRE are selected to YES, under CONFIG : PANEL : OPTIONS, during configuration)

Where:

**A** means Alarm

**F** means Faults

**D** means Disablement

**O** means Other

- Press the return  key or ✓ key to return to the **Main Menu** display.

## Report Menu: OTHER

From the **OTHER** sub-menu; the number of **OTHER** system events (any event not covered by **ALARM**, **FAULT**, **DISABLE**, etc.) is displayed.

To get **OTHER** events information:

- On the **Main Menu**, use Left/Right arrow keys to move cursor to **Report** menu icon and press ✓ key to select.
- From the **Report Menu**, use Left/Right arrow keys to move cursor to select **OTHER** sub-menu. Press ✓ key to select.

- The number (n) of **OTHER** events will be displayed in the following manner:

**OTHER**                    **A 00**   **F 00**   **D 00**   **O nn**

**List of detected other events**

or

**OTHER**            **FFRE : NORMAL/ACTIVE and/or FARE : NORMAL/ACTIVE**

**List of detected other events**

(Displayed if Sounder One FARE and/or Sounder Two FFRE are selected to YES, under CONFIG : PANEL : OPTIONS, during configuration)

Where:

**A** means Alarm

**F** means Faults

**D** means Disablement

**O** means Other

- Press the return  key or ✓ key to return to the **Main Menu** display.

## Report Menu: HISTORY

To get event history information:

- On the **Main Menu**, use Left/Right arrow keys to move cursor to **Report** menu icon and press ✓ key to select.
- From the **Report Menu**, use Left/Right arrow keys to move cursor to select **HISTORY** sub-menu. Press ✓ key to select.

- The **EVENT HISTORY** will open, e.g.:

**nnnn** : **PANEL RESET**

**nnnn** : **BATTERY MISSING**

**nnnn** : **MAINS FAIL**

**Note:** Where **nnnn** represents an automatically assigned four-digit sequential number, allocated to each event.

- Use the Up/Down arrow keys to access relevant event and press ✓ key to display the date and time the selected event occurred:

**nnnn** : **dd-MMM-yy hh:mm:ss**

**Note:** where:

**nnnn** = sequential number automatically allocated to the event

**dd** = day

**MMM** = Month

**yy** = Year

**hh** = hour

**mm** = minutes

**ss** = seconds

- Press the return  key or ✓ key to return to the **Main Menu** display.

## Report Menu: Versions

To access the software Versions information:

- On the **Main Menu**, use Left/Right arrow keys to move cursor box to **Report** menu.
- Press ✓ key to select the **Report** menu.
- Under **Report Menu**, select the **Versions** option and then press ✓ key to access it.
- **Versions** information will be displayed, as follows:

**DISPLAY: VER: n.n\_nnnn**

**SITE DATA: dd-MMM-yy hh:mm:ss nnnn**

**PSU: VER: n.nn**

**GAS AREA ONE: VER: n.n.nn**

**GAS AREA TWO: VER: n.n.nn**

Where:

**n** = displayed number

**dd** = day

**MMM** = Month

**yy** = year

- Next, press return  key or ✓ key to return to the **Report Menu**.

## Report Menu: COUNTER

To get ALARM COUNT information:

- On the **Main Menu**, use Left/Right arrow keys to move cursor box to **Report** menu.
- Press ✓ key to select the **Report** menu.
- Under **Report Menu** select the **COUNTER** option and then press ✓ key to access it.
- The **ALARM COUNT** sub-menu will open, and the following information will be available:

**ALARM COUNT: nnnn** (number (**n**) of alarm events that have occurred)

**LAST ALARM AT: dd-MMM-yy hh:mm:ss** (date and time when the last event happened)

**HOLD DOWN SELECT TO RESET:**

- To reset the alarm count, press and hold down ✓ key and the following will be displayed:

**Enter Level 4 Access Code**

**0 \_ \_ \_**

- Use the keypad to enter code 4444:
  - Press ✓ key
  - Use the Up/Down arrow keys to increase/decrease the number value of the first digit in the 4-digit sequence.
  - Use the Left/Right arrow keys to move to the next digit in the 4-digit sequence
  - When all 4 digits have been set to the code 4444 press ✓ key once again.
- This action will clear to zero the value of any Alarm Count (if more than zero). A short acknowledgement sound will be present.



- Next, press return  key or ✓ key to return to the **Report Menu**. A short acknowledgement sound will be present.

### Report Menu Breakdown

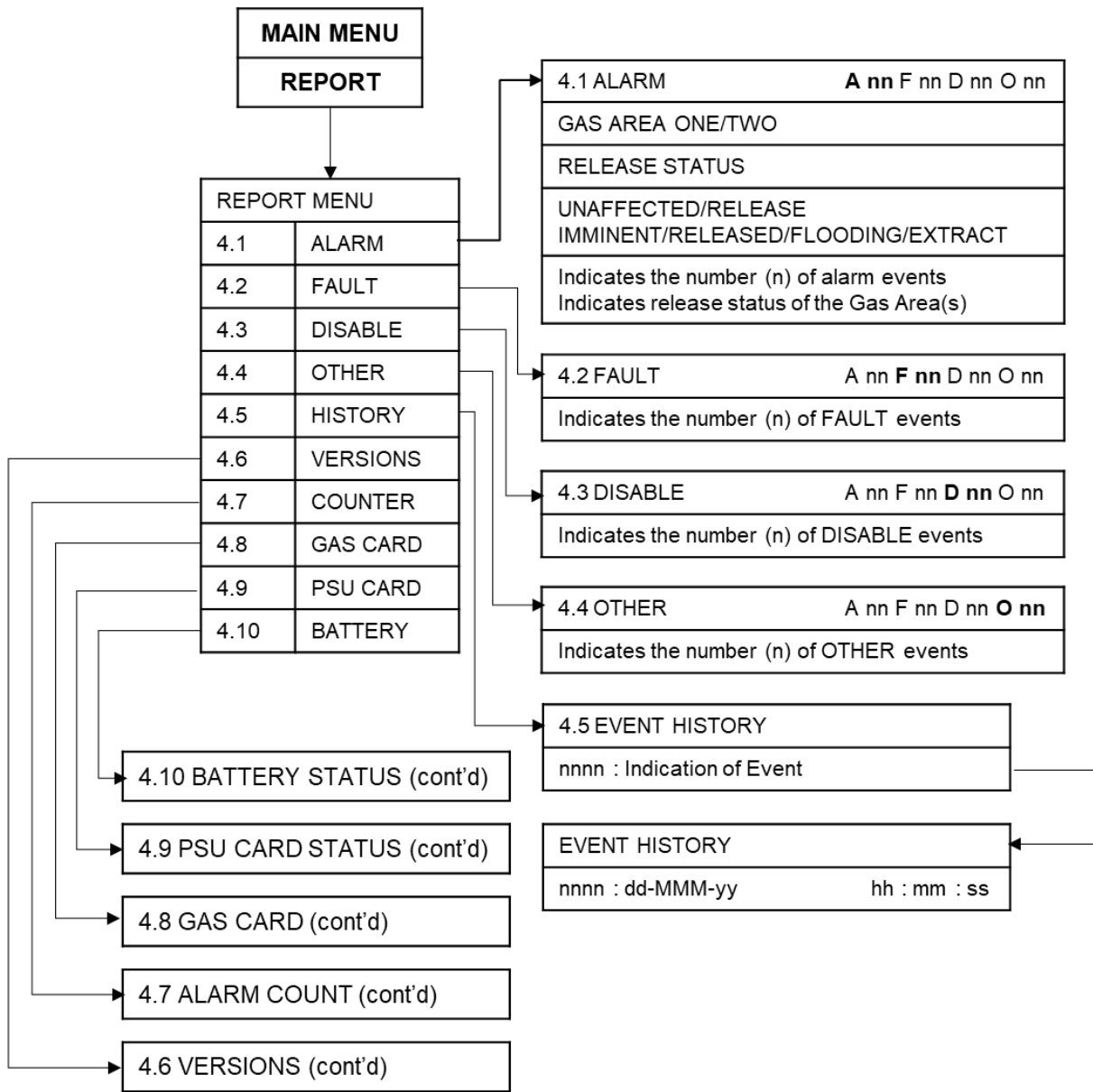

4.6 VERSIONS (cont'd)

4.6 VERSIONS	
DISPLAY:	VER: n.n_nnn
SITE DATA:	dd-MMM-yy hh : mm : ss nnnn
PSU:	VER: n.nn
GAS AREA ONE:	VER: n.n.nn
GAS AREA TWO:	VER: n.n.nn

4.7 COUNTER (cont'd)

4.7 ALARM COUNT	
ALARM COUNT:	nnnn
LAST ALARM AT:	dd-MMM-yy hh : mm : ss
HOLD DOWN SELECT TO RESET	



4.8 GAS CARD (cont'd)

4.8 GAS CARD
ZONE 1 STATUS & ANALOGUE VALUE
ZONE 2 STATUS & ANALOGUE VALUE
ZONE 3 STATUS & ANALOGUE VALUE
SOUNDERS FIRST STATUS
SOUNDERS SECOND STATUS
EXTINGUISHING OP STATUS
MANUAL RELEASE STATUS
PRESSURE SWITCH STATUS
FLOW SWITCH STATUS
HOLD SWITCH STATUS
ABORT INPUT STATUS
AUTO/MAN INPUT STATUS

4.9 PSU CARD (cont'd)

4.9 PSU CARD STATUS
TEMPERATURE
MAINS FAIL/VOLTS FAULT/BATTERY FAULT
IMP FAULT/DISABLED/EARTH FAULT
ONL ANALOGUE VALUE
PULSE INPUT AV/CLASS CHANGE INPUT AV
SOUNDER 1 AV
SOUNDER 2 AV
BATTERY VOLTS AV/BATTERY MON AV
28V AV/28V REF AV
EARTH INPUT AV/SNREF AV
SNMON AV/ITEMP AV

4.10 BATTERY (cont'd)

4.10 BATTERY STATUS
BATTERY TEMP DEGREES CELSIUS
BATTERY VOLTS
CHARGE VOLTS
CURRENT
DAC OP VOLTS VREF INT AV
CALIBRATION VALUE

## ENG Menu

From the **ENG** menu option on the Main Menu, the following sub-menus can be accessed:

- **ENG**
  - Test
    - **ON/OFF**
    - **SETTINGS**
  - **MISC**

The **ENG** menu is used to:

- Test the system and set which Gas Area zones are to be included/excluded from the test
- Remove all disablements, set during configuration.

To access the **ENG** menu:

- Turn **Activate Controls** key clockwise to **On**
- or
- Use the keypad to enter Authorised User (Access level 2) code 1111:
    - Press ✓ key
    - Use Up/Down arrow keys to increase/decrease the number value
    - Use Left/Right arrow keys to move to the next digit in the 4-digit sequence
    - When all 4 digits have been set to the code 1111, press the ✓ key again
  - The **Main Menu** will become available for operation

### ENG Menu: TEST

Test MODE is used when testing the Fire Alarm system. In test mode the devices in the zone(s) in test (detectors, call points, etc.), can be activated and the panel will automatically reset, enabling the system to be tested by one person.

Under the Test MODE sub-menu, the following sub-menus are available to set the parameters for the system test:

- **ON/OFF**
- **SETTINGS**

### Test MODE Menu: ON/OFF

This is the main activation control for Test Mode, any zones that have been set for Test Mode will be disabled (i.e. operate normally) unless overall Test Mode function has been set here.

To set the test mode required:

- On the **Main Menu**, use Left/Right arrow keys to move cursor to **ENG** menu icon and press ✓ key to select.
- From the **ENG Menu**, use Left/Right arrow keys to move cursor to select **Test** sub-menu. Press ✓ key to select.
- From the **Test MODE** menu, use the Left/Right arrow keys to select the **ON/OFF** sub-menu icon. Press ✓ key to select it.
- On the **Test ON/OFF** sub-menu, using Left/Right arrow keys; move cursor to either **ON** or **OFF**, as required. Press ✓ key to select.

**Note:** **ON** will activate Test Mode function, so that any zone set for this mode can be tested.

**Note:** **OFF** will de-activate Test Mode function, so that any zones set for this mode will still activate Fire Alarms in the standard way

- When selection is made, press return  key to return to **Test MODE** sub-menu screen.

### Test MODE Menu: SETTINGS

This menu is used to set which zone(s) are to be tested, along with Sounder option:

- On the **Main Menu**, use Left/Right arrow keys to move cursor to **ENG** menu icon and press ✓ key to select.
- From the **ENG Menu**, use Left/Right arrow keys to move cursor to select **Test** sub-menu. Press ✓ key to select.
- On the **Test MODE** menu, use Left/Right arrow keys to select **SETTINGS** sub-menu. Press ✓ key to select.
- The **Test SETTINGS** menu will display the following options:

#### -GENERAL-

1: SOUNDERS: EXCLUDED / TESTING

#### -GAS AREA ONE-

2: Zone ONE: EXCLUDED/TESTING

3: Zone TWO: EXCLUDED/TESTING

4: Zone THREE: EXCLUDED/TESTING

#### -GAS AREA TWO- (for twin Flood Zone panels)

5: Zone FOUR: EXCLUDED/TESTING

6: Zone FIVE: EXCLUDED/TESTING

7: Zone SIX: EXCLUDED/TESTING

- Use the Up/Down arrow keys to select the required option.
- Press ✓ key to toggle between **Excluded** and **Testing**.

Press return  key to accept and return to **Test MODE** sub-menu.

Press return  key to accept and return to **ENG** menu.

**Note:** The indicated states are either **EXCLUDED** (i.e. excluded from Test) or **TESTING** (i.e. included in the Test). Any zones set to **TESTING** will create a non-latching fire alarm with unaffected Release status when activated, without any sounder activation, unless sounders have been included in the test in which case, they will all pulse twice then go silent. Sounders if set for testing will still operate normally to fires detected on zones excluded from testing.

## ENG Menu: MISC

The **MISC** sub-menu is used to remove all disablements currently set in the system:

- On the **Main Menu**, use Left/Right arrow keys to move cursor to **ENG** menu icon and press ✓ key to select.
- From the **ENG Menu**, use Left/Right arrow keys to move cursor to select **MISC** sub-menu. Press ✓ key to select.
- The **MISC OPTIONS** menu will now be displayed, as follows:  
**1: REMOVE ALL Disablement**
- Highlight the **REMOVE ALL Disablement** option and press ✓ key to select.
- A confirmation dialog, with options for **NO/YES**, will appear.
- Use Left/Right arrow keys to highlight the **YES** option and press ✓ key to select. A short acknowledgement sound will be present.
- When selection is made, press return ↵ key to return to **MISC** menu.
- Press return ↵ key to return to **ENG** menu.

**ENG Menu Breakdown**

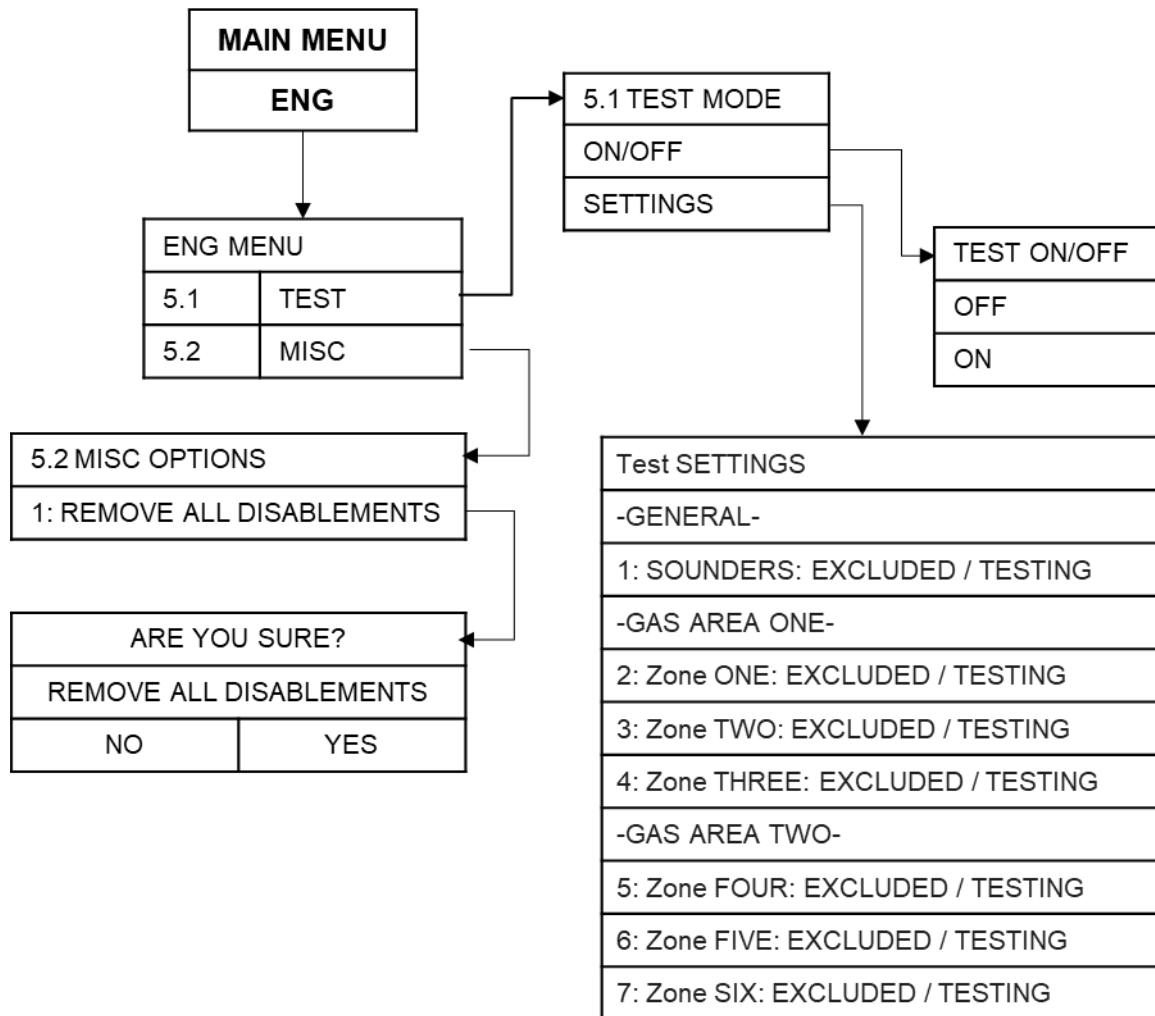

## SERVICE & MAINTENANCE

Periodic system maintenance should be carried out on the system as prescribed in the local design, maintenance and installation regulations.

The fire alarm panel's standby batteries should be checked for:

- integrity of the connections
- deposits indicating venting
- aperiodic load test, with the Mains supply disabled, to ensure adequate battery capacity.

Both batteries should be renewed if there is any doubt about their integrity. The memory log should be checked for any faults that have automatically cleared, and these dealt with accordingly.

The 'Responsible Person' should check perform periodic system maintenance. This equipment should be maintained in accordance with the local regulations and codes appropriate to the country and location of installation.

