



# ESENTO<sup>®</sup>

## ECLIPSE

EN54 APPROVED 2 - 4 ZONE CONVENTIONAL CONTROL  
PANEL

### Installation, Commissioning & Operating Manual



810a/03



2831

**Haes Technologies Ltd, Unit 3 Horton Industrial Park, West Drayton, UB7 8JD**

**13**

**Model Number**

Eclipse 2-4 zone conventional panel ECL-2/4

**CPD Number**

2831-CPR-F0670

European Standard EN54-2 : 1997 + A1 : 2006  
Control and indicating equipment for fire detection and fire alarm systems for buildings.

Provided Options (with requirements):  
Output to fire alarm devices, dependency type 'A', test condition

European Standard EN54-4 : 1997 + A1 : 2002 + A2 : 2006  
Power supply equipment for fire detection and fire alarm systems for buildings.

### IMPORTANT NOTE

**PLEASE READ THIS MANUAL BEFORE HANDLING THE EQUIPMENT AND  
OBSERVE ALL ADVICE GIVEN IN IT**

**THIS PARTICULARLY APPLIES TO THE PRECAUTIONS NECESSARY TO AVOID**

**E.S.D**

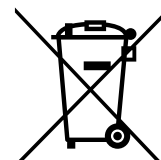

**ATTENTION**



**IMPORTANT SAFETY NOTES**

The panel is safe to operate provided it has been installed in compliance with the manufacturer's instructions and used in accordance with this manual.

Hazardous voltages are present inside the panel—DO NOT open it unless you are qualified and authorised to do so. There is no need to open the panel's enclosure except to carry out commissioning, maintenance and remedial work. This work must only be carried out by competent service personnel who are fully conversant with the contents of the panel's installation manual and have the necessary skills for maintaining this equipment.

This fire alarm system requires periodic checks as specified in BS 5839 Part 1 It is the responsibility of the system user to ensure it is regularly serviced and maintained in good working order.

Disclaimer

No responsibility can be accepted by the manufacturer or distributors of this fire alarm panel for any misinterpretation of an instruction or guidance note or for the compliance of the system as a whole. The manufacturer's policy is one of continuous improvement and we reserve the right to make changes to product specifications at our discretion and without prior notice. E & O E.

---

	<b>Page</b>
<b>ABOUT THIS PANEL</b>	<b>2</b>
PRODUCT OVERVIEW	2
CABINET DETAILS	3
CIRCUIT BOARDS	4
MAIN PCB TERMINALS	5
TECHNICAL SPECIFICATION	6
POWER SUPPLY MODULE	7
<hr/>	
<b>DESIGN CONSIDERATIONS</b>	<b>8</b>
SYSTEM DESIGN & PLANNING	8
GENERAL CONVENTIONAL WIRIING SCHEMATIC	10
GENERAL TWIN WIRE WIRIING SCHEMATIC	11
<hr/>	
<b>INSTALLATION</b>	<b>12</b>
SAFETY	12
ESD PRECAUTIONS	13
GENERAL	13
MOUNTING THE CABINET	13
MAINS CONNECTIONS	14
CONNECTING THE BATTERIES	15
<hr/>	
<b>SETUP &amp; PROGRAMMING</b>	<b>16</b>
TWIN WIRE MODE	16
LEVEL 3 ENGINEERING OPTIONS	17
ZONE INTERFACE FUNCTION	25
<hr/>	
<b>OPERATING</b>	<b>26</b>
PANEL CONTROLS & INDICATIONS	26
DISABLE MODE	28
TEST MODE	29
FAULT DIAGNOSIS	30
FUNCTIONALITY DURING A SYSTEM FAULT	31
USER INSTRUCTIONS	31
<hr/>	
<b>SERVICE &amp; MAINTENANCE</b>	<b>32</b>
THE NEED FOR MAINTENANCE	32
DUTIES OF THE RESPONSIBLE PERSON	32
ROUTINE MAINTENANCE & TESTING	32
SCHEDULE OF TESTING LOG BOOK	34
FALSE ALARMS, FAULTS & ENGINEER VISIT LOG BOOK	40

---

## PRODUCT OVERVIEW

Eclipse is a 2 or 4 zone Conventional /Twin Wire (sav-wire) control panel with integral power supply & space for standby batteries.

Eclipse panels are fully approved to European standards EN54-2 & 4, Fire Detection and Alarm Systems – Control & Indicating Equipment.

The control panel comprises of a sheet steel enclosure suitable for wall mounting with a hinged, lockable front access door. It can be semi recessed, using a suitable recessing bezel. Cable entry is via 20mm 'knockouts' located at the top and rear of the cabinet.

Different key types are used for the door lock and the 'activate controls' key-switch. It is also possible to enable the controls via a 4 digit code entry if preferred. An eight button keypad is used to control the system and allow access to the function options. The three main buttons, 'RESOUND' (red), 'SILENCE' (blue) and 'RESET' (green) being much larger and colour coded to assist the end users.

Two or four fire zone circuits are provided plus two monitored sounder circuits. Fire & Fault VFCO relays, Fire & Fault switched negative outputs, class change and an alert input are also included. The fire zone outputs can be set as 'Twin Wire' by DIL switch selection. In 'Twin Wire' configuration, special detector bases and call points must be used.

Eclipse panels support a large range of conventional detectors including, Apollo, Hochiki & Nittan.

The panels are supplied with a 1.5 amp internal power supply module. This module complies with the requirements of EN54-4 : 1988 and provides temperature compensated battery management charging.

Quiescent and alarm current details for standby battery calculations

Model	Standby Current	Alarm Current
ECL-2	75mA	116mA
ECL-2 (set to Twin Wire mode)	75mA	134mA
ECL-4	85mA	133mA
ECL-4 (set to Twin Wire mode)	85mA	170mA

**CABINET**

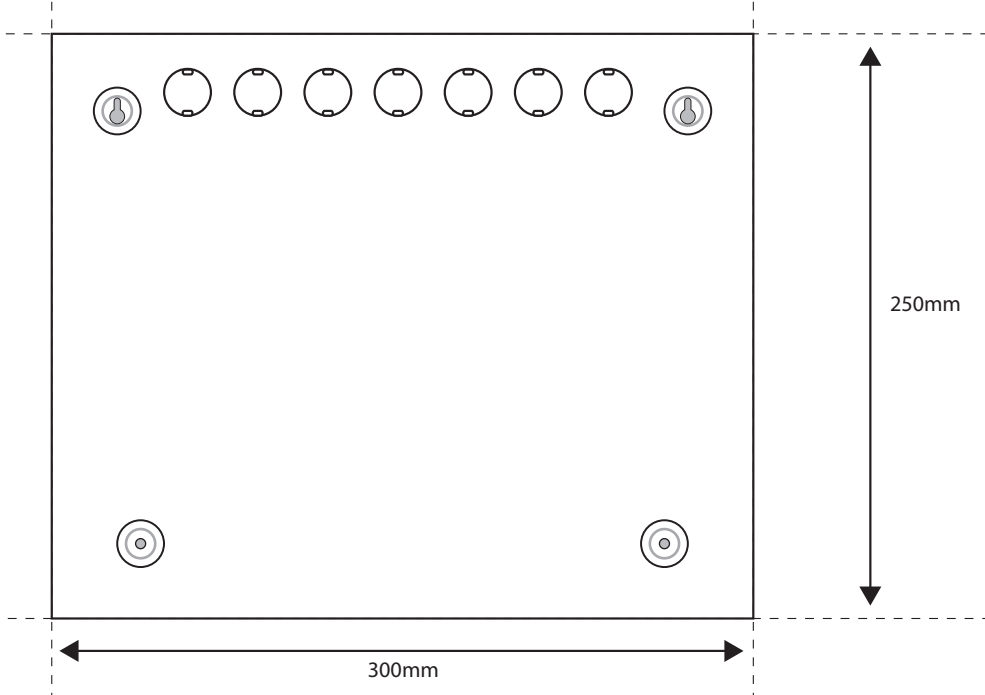
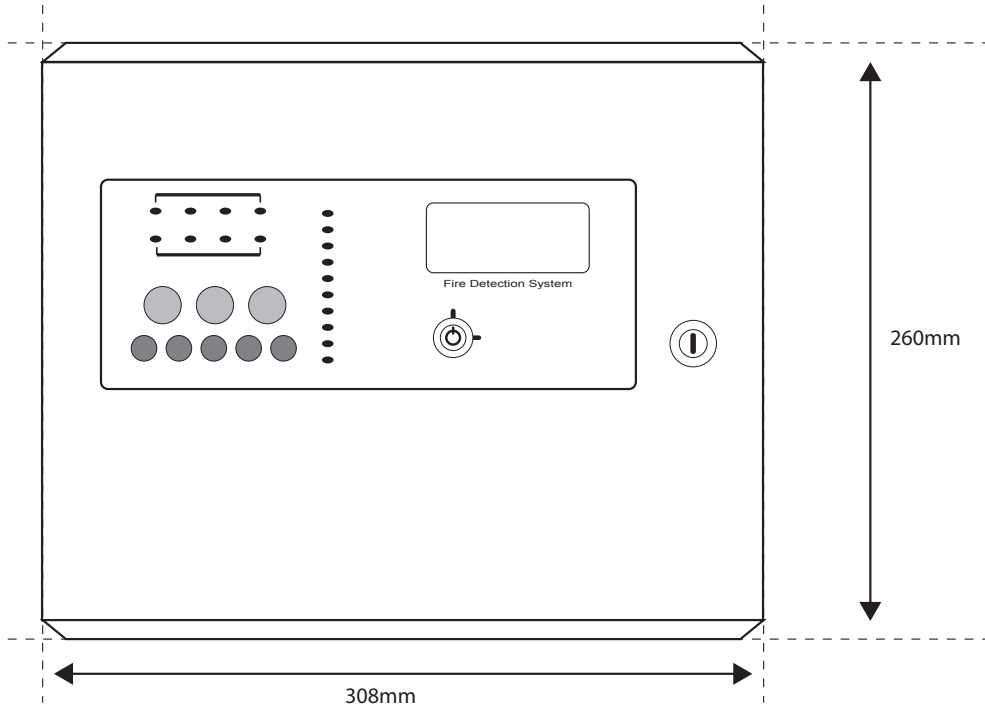
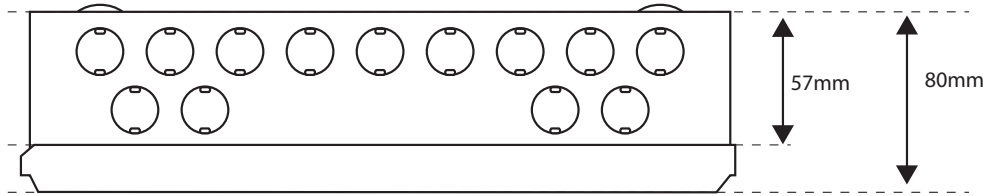

## CIRCUIT BOARDS

Eclipse panels comprise of two circuit boards

TPCA01-E2/E4 - 2 or 4 zone Master PCB

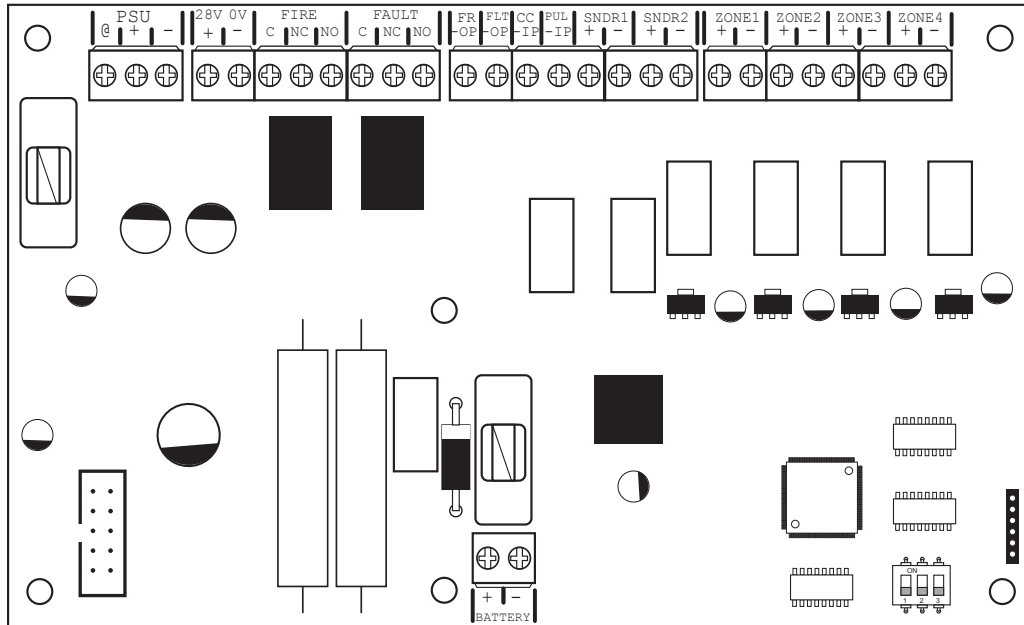

TPCA02 - LED Display & Controls PCB

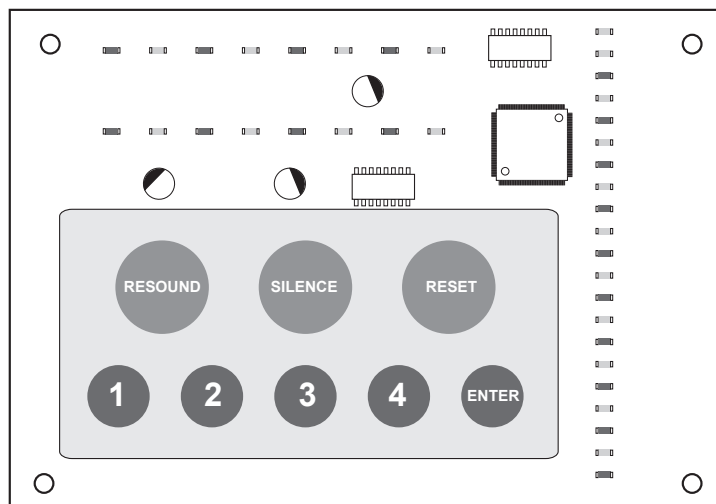

**MAIN PCB TERMINALS**

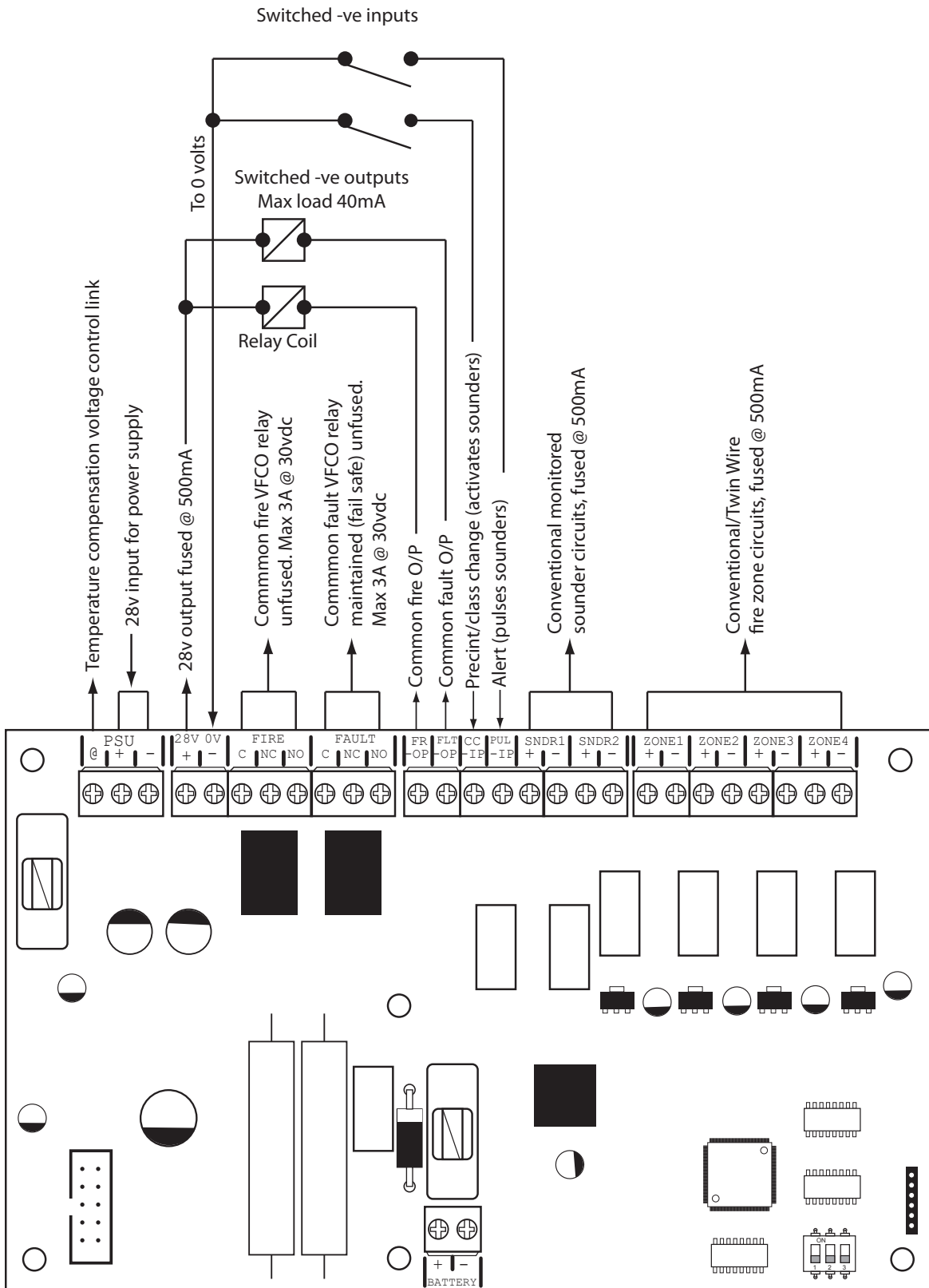

## TECHNICAL SPECIFICATION

<b>Electrical Specification Inputs &amp; Outputs - TPCA01-E2/E4</b>		
Cabling	Fire resistant screened cable, minimum size 1mm <sup>2</sup> . Max cable length 1Km (20 Ohm). FireBurn, FP200 or equivalent (max capacitance 1uF, max inductance 1 millihenry).	Suitable cable glands must be used.
Terminal capacity	0.5mm <sup>2</sup> to 2.5mm <sup>2</sup> solid or stranded wire.	
PSU @ output	Power supply voltage control line.	For temperature compensation control.
PSU Input + -	28vdc supply input. Diode protected for reversal and independent short circuit. Max current 3 amps.	Max input current 3 amps. Input voltage 22vdc to 32vdc.
28v+, 0v- power output	28vdc supply output for fire alarm accessory relays etc. Max continuous use = 400mA.	Fused @ 500mA. Fuse = 500mA resettable fuse.
Common fire relay	Fire relay contact. Clean C/O. Max 3A @ 30vdc	Unfused
Common fault relay	Maintained fault relay contact. Clean C/O. Max 3A @ 30vdc	Unfused
Outputs; FR, FLT	Switched -ve voltage outputs for relay control.	Overload voltage protected to 52vdc. Current limited 680R. Max load = 40mA
Inputs; CC, PUL	Switched -ve inputs, connect to 0v to trigger. Max input voltage = 28vdc. Non latching, max resistance 100R.	Protected via 10K Ohm impedance, 3v6 zener diode.
SNDR 1 - 2	28vdc polarity reversal monitored sounder outputs to fire alarm devices. 4K7 Ohm 5% 0.25W EOL resistor.	Monitoring current limit 28mA, fused @ 500mA. Typical max load 22 devices @ 18mA each per circuit. Ensure 0.9A is not exceeded.
Zone 1 - 4	Fire alarm zone circuits. Conventionally wired detection circuit or Twin Wire combined detection / sounder circuit. 4K7 Ohm 5% 0.25W EOL resistor.	Monitoring current limit 50mA, fused @ 500mA. Typical max load 22 alarm devices @ 18mA each per circuit. Ensure 0.9A is not exceeded.

<b>General Specification</b>	
Enclosure	Steel IP30. Epoxy powder coated Interpon Radon, silver grey
Temperature range	-5 deg C to +40 deg C max RH 95%
Number of conventional/Twin Wire detection circuits	2 or 4
Conventional/Twin Wire detector compatibility	Apollo: S65, Orbis. / Hochiki CDX. / Nittan EV



**POWER SUPPLY MODULE**

<b>Power Supply Specification</b>		
Mains supply	230vac +10% / -15% 50Hz max current 1A	
Mains supply fuse	2 Amp (T2A 250V)	Not accessible for servicing. Internal to switch mode power unit
Internal power supply rating	1.5 Amps total including battery charging	Maximum load shared between outputs = 0.9A
Power supply output voltage	19.92 - 30.09vdc	Tolerance +/- 0.1%
Maximum continuous load for battery standby (ImaxA)	ImaxA = 575mA	ImaxB not specified
Minimum current drawn by panel (example)	4 Zone I min = 85mA	2 Zone I min = 75mA
Maximum ripple	120 mV p-p	Supply and charger fault monitored
Min/max battery size and type	2 x 3.2Ahr 12volt VRLA Use Yuasa NP range batteries	Batteries shall comply to BS 62368-1 requirements. Fire rated batteries shall be used.
Battery charging voltage	27.3 vdc nominal at 20 deg C	Temperature compensated
Battery charging output current	1.5A PSU 630mA Current limited 10 Ohms	
Battery high impedance fault (Batt Hi Z)	Resistance > 1 Ohm	1 hour reporting time
Max current drawn from batteries	1.5 Amps with main power source disconnected. Battery fuse 3A LBC 20mm.	

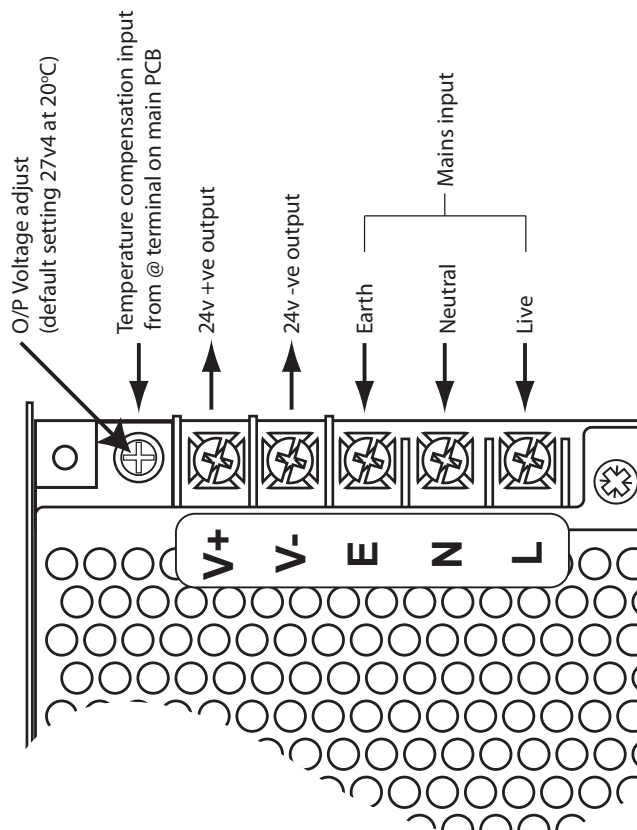

## SYSTEM DESIGN & PLANNING - A few handy tips

This guide is intended as an aid to designers and installers of fire detection systems. It is NOT to be used as a substitute to BS5839 which should be read in full.

### What is a detection zone?

In order to direct those responding to a fire alarm signal, particularly the fire service, to the area of a fire, all buildings, other than very small buildings, need to be divided into detection zones. Detection zones need to be small enough for a fire to be located quickly.

- If the total floor area of the building is greater than 300m<sup>2</sup>, each zone should be restricted to a single storey
- If the total floor area of the building is less than 300m<sup>2</sup> a zone may cover more than a single storey
- For voids above or below the floor area of a room, these may be included within the same zone of the room, provided that the void and the room constitute a single fire compartment
- The floor area of a single zone should not exceed 2000m<sup>2</sup>.

### Detectors

- A person searching a zone for a fire in a non- addressable fire system should not have to travel more than 60m to identify the source of a fire
- The sensing element of a smoke detection device should not be less than 25mm and not more than 600mm below ceiling
- The sensing element of a heat detector should not be less than 25mm and not more than 150mm below ceiling
- When mounted on a flat ceiling, smoke detection devices have an individual coverage of 7.5m radius. However these radii must overlap to ensure there are no 'blind spots'. Therefore individual coverage can be represented by a square measuring 10.6m x 10.6m giving an actual coverage of 112m<sup>2</sup> per device
- When mounted on a flat ceiling, heat detection devices have an individual coverage of 5.3m radius. However these radii must overlap to ensure there are no 'blind spots'. Therefore individual coverage can be represented by a square measuring 7.5m x 7.5m giving an actual coverage of 56.3m<sup>2</sup> per device.

### Call Points

- A person should not have to travel more than 45m along an escape route to reach a Manual Call Point (25m if disabled person to operate, or rapid fire development is likely). Manual Call Points should be sited at all stair wells and exits from the building.
- The frangible element of the manual call point should be positioned 1.4m (+/- 200mm) from the floor level. (Unless a wheelchair user is likely to be the first person to raise the alarm).

### Sounders

- Sounder device cabling should be arranged so that in the event of a fault, at least one sounder will remain operational during a fire condition.
- The minimum sound level should be 65dB(A) or 5dB(A) above a background noise which is louder than 60dB(A) (if lasting more than 30 seconds) and at a frequency of between 500Hz and 1000Hz. The maximum sound level should not be greater than 120dB(A) at any normally accessible point. This may be reduced to 60dB(A) in stairways, enclosures up to 60m<sup>2</sup> and specific points of limited extent.
- For areas where people are sleeping, sounder devices should produce a minimum 75dB(A) at the bed-head with all doors shut. In buildings providing sleeping accommodation for a significant number of people, all bedrooms should have both audible and visual alarms.

**Beacons**

- Visual alarms such as beacons, should always be mounted at a minimum height of 2.1m from floor level.

**General**

- Fire Alarm Control Panels should be installed at a location appropriate for staff and fire fighters
- All mains supply isolators must be double pole and suitably marked
- All joints to be fire resisting, junction boxes to be labelled 'FIRE ALARM'.
- All cables to be fire resisting with a minimum cross-sectional area of 1mm<sup>2</sup>.
- Cable using trunking as a means of containment must be clipped using fire resistant supports WITHIN THE TRUNKING.
- Zone charts should be fitted in all appropriate locations (adjacent to control equipment and repeaters).

**CABLE TYPES & LIMITATIONS**

To comply with EMC (Electro Magnetic Compatibility) regulations and to reduce the risk of electrical interference in the system wiring, we recommend the use of screened cables throughout the installation. Acceptable, commonly available, screened cables, which can be used on both the sounder and detector circuits include, NoBurn™ FP200™, Firetuff™, Firecel™, MICC (Pyro™) or any other cable complying with BS 6387 categories C, W, Z.. Refer to BS 5839 pt1 clause 26 for detailed information on cables wiring and interconnections.

**CABLING**

Suitable cables should be brought into the cabinet using the knockouts provided via a suitable cable gland recommended for use with that cable. The screen or drain wire of circuits should be bonded to earth at one location only, and should be continuous throughout the circuit. Drain wires should be terminated in the cabinet using the earthing terminal provided.

**CABLE LENGTHS**

The maximum recommended cable length for a zone or sounder circuit is 1Km. This, however, is highly dependant on the number and type of devices connected.

If in doubt, cable load and resistance calculations should be undertaken to ensure devices are working within specified limits.

**MAINS PROVISION**

The mains supply to the fire alarm panel should be hard wired, using suitable three core cable (no less than 1.0 mm<sup>2</sup> and no more than 2.5mm<sup>2</sup>) or a suitable three conductor system that meets the appropriate national wiring regulations. The panel should be fed from an isolating switched fused spur, supplied directly from the Main Distribution Board, fused at 3A. This should be secure from unauthorised operation and be marked 'FIRE ALARM'.

The mains supply must be exclusive to the fire panel.

As an alternative to a switched fused spur, an appropriately fused double pole isolating device may be used providing it meets the appropriate national wiring regulations.

All system wiring should be installed to meet BS5839 Pt 1 : 2002 and BS7671 (Wiring Regulations). Other national standards of installation should be used where applicable.

## GENERAL CONVENTIONAL SYSTEM SCHEMATIC

### Typical Conventional Detection Circuit Wiring

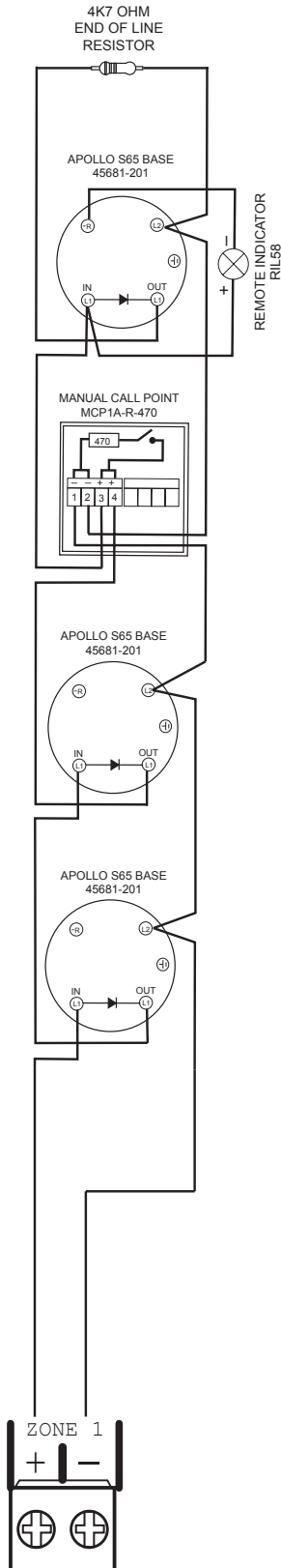

### Typical Conventional Sounder Circuit Wiring

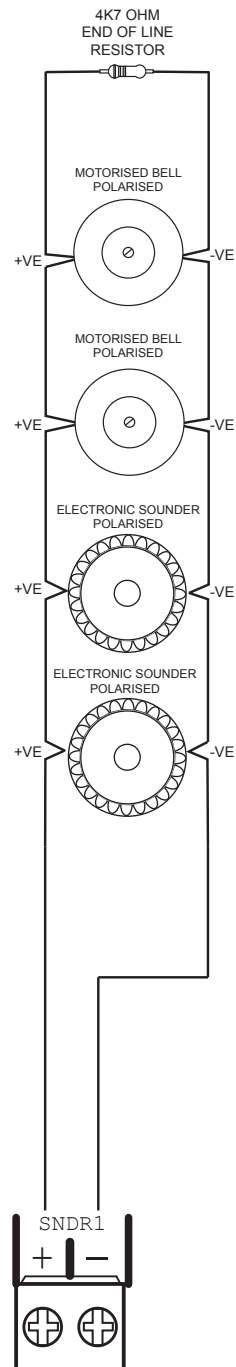

**GENERAL TWIN WIRE SYSTEM SCHEMATIC**

**Typical Twin Wire  
Circuit Wiring**

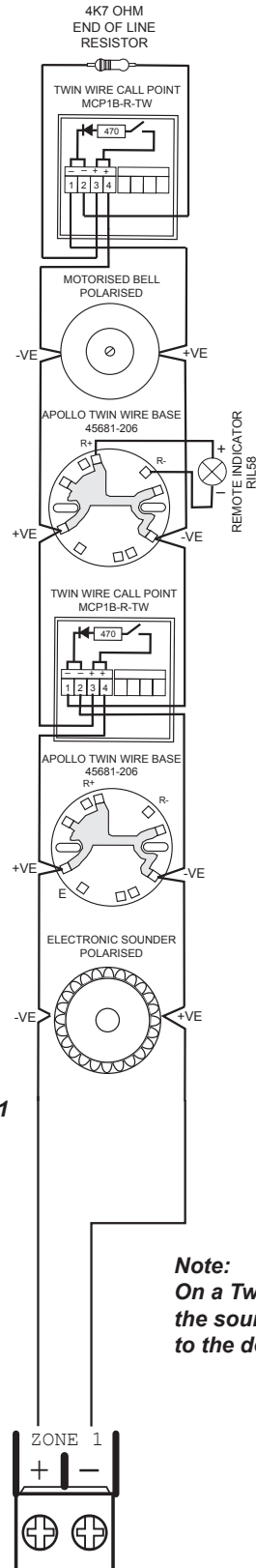

**Note:**  
Zone circuit configuration  
is set to 'Conventional' by default.  
'Twin Wire' mode must be set using DIL Switch 1  
on Main PCB.

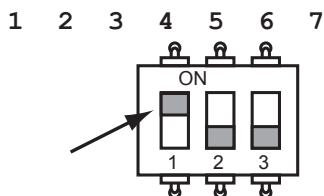

**Note:**  
On a Twin Wire circuit  
the sounders are connected in reverse polarity  
to the detectors and call points

## SAFETY

Suppliers of articles for use at work are required under section 6 of the Health and Safety at Work Act 1974 to ensure as reasonably as is practical that the article will be safe and without risk to health when properly used. An article is not regarded as properly used if it is used “without regard to any relevant information or advice” relating to its use made available by the supplier.

It is assumed that the system, of which this control panel is a part, has been designed by a competent fire alarm system designer in accordance with BS 5839 Part 1 and with regard to BS EN 54 parts 2 and 4 in the case of control equipment and power supplies. Design drawings should be provided to clearly show the position of any field devices and ancillary equipment.

This product should be installed, commissioned and maintained by, or under the supervision of, competent persons according to good engineering practice and,

- (i) BS 7671 (IEE wiring regulations for electrical installations)
- (ii) Codes of Practice
- (iii) Statutory requirements
- (iv) Any instructions specifically advised by the manufacturer

According to the provisions of the Act you are therefore requested to take such steps as are necessary to ensure that any appropriate information about this product is made available by you to anyone concerned with its use.

This equipment is designed to be operated from 230V AC 50/60 Hz mains supplies and is of Class I construction. As such it must be connected to a protective earthing conductor in the fixed wiring of the installation. Failure to ensure that all conductive accessible parts of this equipment are adequately bonded to the protective earth will render the equipment unsafe.

	<p>This equipment must only be installed and maintained by a suitably skilled and technically competent person.</p> <p><b>THIS IS A PIECE OF CLASS 1 EQUIPMENT AND MUST BE EARTHED</b></p>
---	--

These panels are designed to comply with the requirements of EN 54 part 2.

Installation of the panel should only be carried out by qualified personnel. The electronic components within the panel can be damaged by static charge. Suitable precautions must be taken when handling circuit boards. Never insert or remove boards or components, or connect cables, with the mains power on or batteries connected.

<b>Equipment Guarantee</b>	
This equipment is not guaranteed unless the complete system is installed and commissioned in accordance with the laid down national standards by an approved and competent person or organisation.	
	This product has been manufactured in conformance with the requirements of all applicable EU Council Directives

**ESD PRECAUTION**

Electronic components are vulnerable to damage by Electrostatic Discharges (ESD). An ESD wrist strap, suitably grounded, should be worn at all times when handling pcbs. These wrist straps are designed to prevent the build up of static charges, not only within a persons body, but on many other materials. ESD damage is not always evident immediately, faults can manifest themselves at anytime in the future. All pcbs should be stored in static shielded bags (silvered) for safe keeping, when not mounted in the control panel.

**GENERAL**

Care should be taken with regards to avoiding the close proximity of high voltage cables or areas likely to induce electrical interference. Earth links should be maintained on all system cables and grounded in the control panel. The detection and sounder circuit cabling is classed as extra low voltage and must be segregated away from mains voltage.

- Any junction boxes used should be clearly labelled FIRE ALARM.
- Any ancillary devices, e.g. door retaining magnets, must be powered from a separate power source.
- Any coils or solenoids used in the system must be suppressed, to avoid damage to the control equipment.

**MOUNTING THE CABINET**

The site chosen for the location of the panel should be clean, dry and not subject to shock or vibration. Damp, salt air or environments where water ingress or extremes of temperature may affect the panel must be avoided. The temperature should be in the range  $-5^{\circ}$  to  $+40^{\circ}\text{C}$ , and the relative humidity should not exceed 95%.

Before mounting the cabinet remove the main PCB.

Remove the power supply module connecting wires from the main PCB, taking care to note where to re-connect them. The main PCB can then be carefully pulled off it's mounting clips.

Secure the cabinet to the wall using the four indented holes in the back box. Ensure the box is mounted level and in a convenient location where it may be easily operated and serviced.

External cables should be glanded via preformed knockouts at the top and rear of the cabinet. Remove any knockouts and ensure the cabinet is clear of swarf etc prior to refitting the PCB. Always ensure that if a knockout is removed, the hole is filled with a good quality cable gland. Any unused knockouts must be securely blanked off.

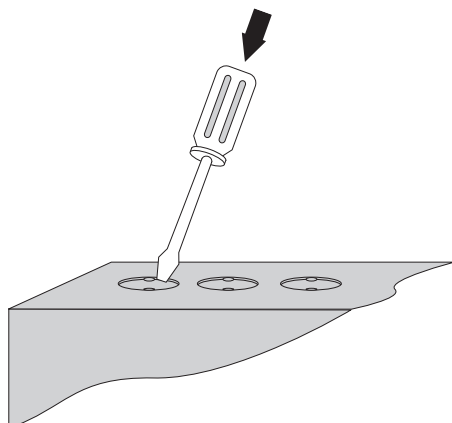

Knockouts should be removed with a sharp tap at the rim of the knockout using a flat 6mm broad bladed screwdriver.

Use of excessive force will damage the enclosure around the knockout.

Typical panel layout

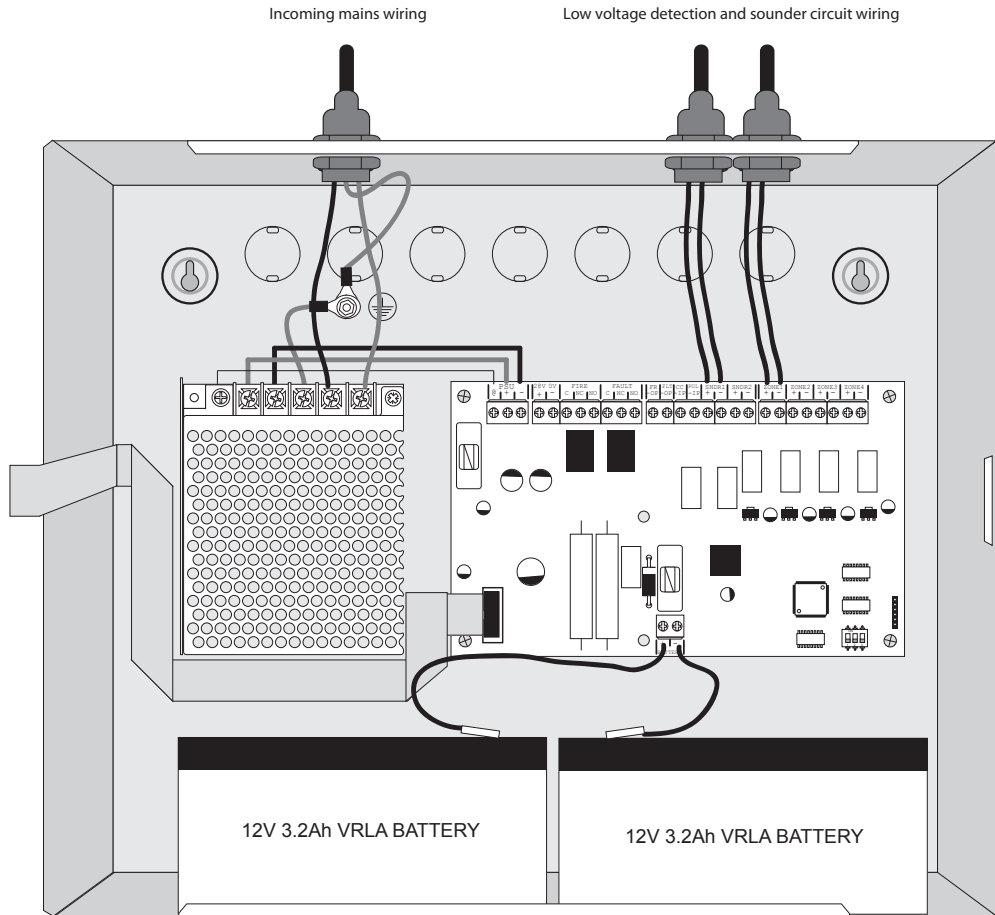

Drawing shows typical internal layout of the panel cabinet with two 3.2Ah, 12v batteries fitted

## MAINS CONNECTIONS

Do not connect the mains supply to the panel until you are fully conversant with the layout and features of the equipment.

A rating plate is attached to the power supply module describing the nature of the supply permitted.

The incoming mains supply should be brought into the panel via one of the knockouts provided.

A suitable cable gland must be used to secure the outer sheath of the cable used. The earth must first be connected to the primary earth stud (peg) marked with a , using a suitable ring crimp.

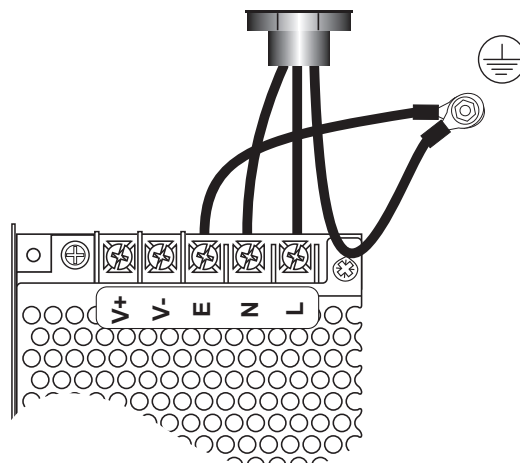

Sufficient earth lead should be left to allow Live and Neutral connections to be accidentally pulled from the terminal block while leaving the earth connection intact.



## CONNECTING THE BATTERIES

Batteries of even very small capacity are capable of delivering very high currents which can cause fire or injury, therefore battery connections should be done with caution.

The panel is supplied with battery leads already connected to the battery terminals on the main PCB. These leads are coloured red for +ve and black for -ve.

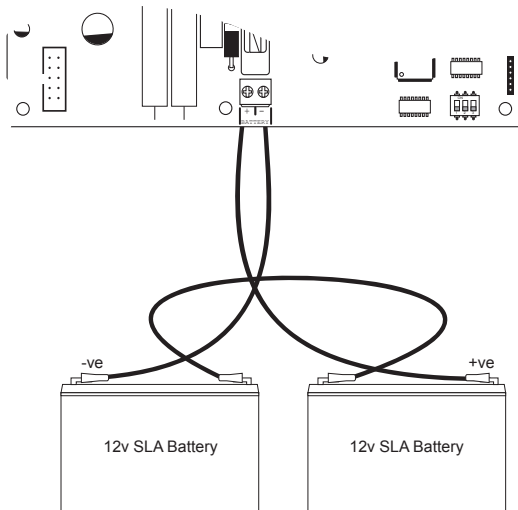

2 x 12v batteries should be connected in series using the white jumper lead provided. See diagram.

To optimise the service life of the batteries, the battery charger output voltage varies with temperature.

**N.B.**

In the event of mains failure, the battery charger circuit will protect the batteries from full discharge by disconnecting them when they reach below 19v. When the mains supply is restored the batteries will be automatically reconnected.

**NOTE:**

If the mains is connected before the batteries, the panel will show a Power Supply fault for up to 1 minute until the monitoring cycle has finished polling. This is normal. If the fault doesn't clear after 1 minute, check connections.

## BATTERY CHARGING VOLTAGE CHECKS

The battery charging voltage is factory calibrated to 27.3vdc +/- 0.2v @ 20°C. This should not normally require adjustment. Where battery problems are experienced, the following information should be considered.

- a) If a battery is disconnected from the charger, no voltage will appear on the output leads or terminals, due to intelligent battery controls.
- b) Check the power supply voltage at the 28v & 0v supply output terminals. With the batteries disconnected the voltage should be 27.6vdc +/- 0.2v @ between 11°C - 40°C.
- c) To test the batteries, turn off the mains and see if the system will run on the batteries. Check the battery voltage, should be 26.8v for a good battery or 22v for a flat battery.
- d) The power supply voltage can be adjusted using the potentiometer on the power supply module (see page 7), checking at the 28v & 0v output terminals with a calibrated volt meter. Batteries should be disconnected and the Access Level 3 DIL switch should be set to 'ON' (see page 17), which will override the temperature compensation controls. Carefully adjust the voltage to 27.6vdc +/- 0.2v. When completed, switch off Access Level 3 DIL switch and re-connect the batteries.
- e) When the panel is re-charging a low battery, it should be possible to see the voltage across the batteries increase gradually. If this is not occurring, the batteries or the panel may be faulty.

## TWIN WIRE MODE

### What is Twin Wire?

Twin Wire is Haes' version of what is often referred to as sav wire. The technology enables sounders and beacons to be connected to the same circuit as the detectors and call points. This can result in greatly reduced installation time and cost.

### How does it work?

In Twin Wire configuration the fire zone circuits reverse polarity in alarm condition to power the sounders and beacons. For this reason the sounders and beacons need to be wired in opposite polarity to the detectors and call points, i.e. zone positive wire connects to detector base and call point positive terminals but sounder and beacon negative terminals.

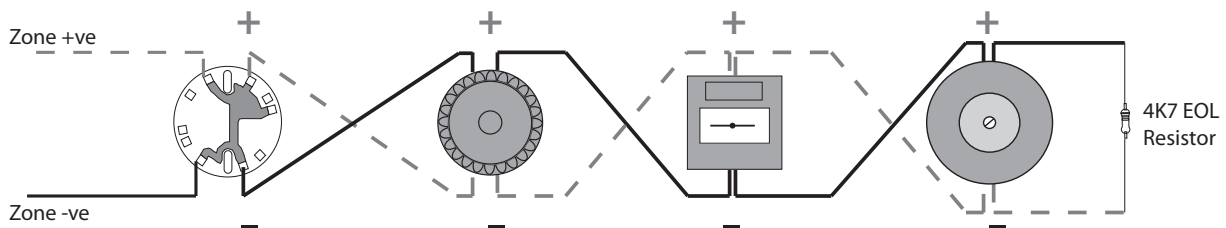

Haes Twin Wire systems require special 'sav-wire' detector bases and polarised call points but standard sounders. Most modern, non addressable, low current, polarised sounders, bells and beacons are compatible, Cooper Fulleon, Besson, Klaxon etc.

To set Twin Wire mode, move switch 1 on the 3 way DIL switch located on the main PCB to the 'ON' position.

**Note:** Setting this switch will change ALL zones to Twin Wire.

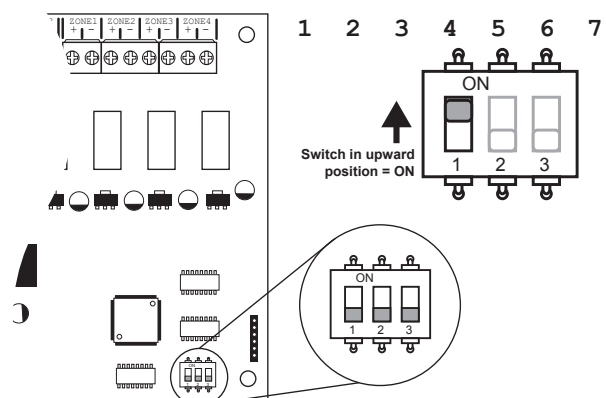

**LEVEL 3 ENGINEERING OPTIONS**

A series of programmable engineering options are available. These programming modes are initiated by entering a four digit code using buttons 1 - 4 on the keypad followed by the ENTER button.

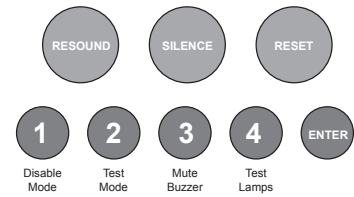

To access Level 3 options, first set switch 3 on the 3 way DIL switch located on the main PCB to the 'ON' position. Then activate the controls by turning the key switch or by entering the four digit code (see Activate Controls in the OPERATING section).

The 'Access Level' indicator will pulse rapidly to signify that Level 3 access is active.

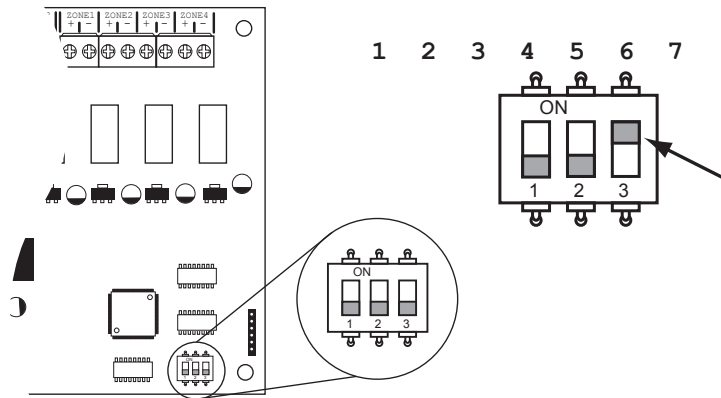

**Options**

① ① ① ③ **Reset all disablements, test modes and parameters back to factory settings.**

Enter the above code and press the ENTER button.

Then press the ENTER button again and hold for 3 seconds.

Any disablements or test mode settings will now clear and all engineering option parameters will revert back to factory settings.

The panel will bleep to acknowledge the reset.

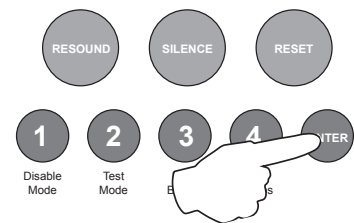

## 2 2 2 4 Set fault buzzer volume.

There are two levels of volume for the internal fault buzzer, high and low.

Enter the above code and press the ENTER button to increase or decrease the fault buzzer tone from the previous level.

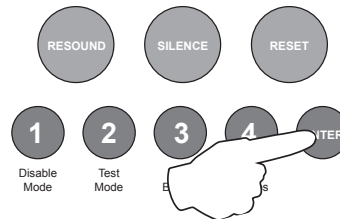

Setting will change when ENTER button is pressed.

When finished, enter the next programming code or disable the controls and return DIL switch 3 to 'OFF'.

## 2 1 2 3 Set keypad entry code (fire LED 1 option)

The keypad can be used to activate the panel controls instead of using the key switch. The default code is 1-2-3-4, however, this can be changed. It is also possible to disable the use of a code entry to enable controls, forcing the use of the key switch only.

Enter the above code and press the ENTER button. The Zone Fault/Disabled/Test LEDs will start to rapidly pulse in sequence to show the currently set code. The sequence will be repeated twice after which time the panel will automatically drop out of the set keypad entry mode.

Whilst the current code sequence is being repeated start to enter the new code. Enter the new code slowly and deliberately, one number at a time. The corresponding Zone Fault/Disabled/Test LED will rapidly pulse to confirm each entry.

**Note: Enable Controls codes must always start with a 1 or 2.**

When finished entering the new four digit code, press the ENTER button. The panel will then confirm the new code with rapidly pulsing LEDs in sequence, after which time the panel will automatically drop out of the set keypad entry mode.

Changing the keypad code to 1 - 1 - 1 - 1 will disable the use of a keypad to enable controls.

## 2 1 2 3 Fire LED 2 future option (not in use)

① ① ① ④ **Select sounder resound options for zones.**

By default, after an initial fire condition and the (blue) Silence Alarms button has been activated, any new fire condition in a different zone will cause the alarms to resound.

It is possible to change this on a zonal basis so that any new alarm in a different zone will not resound the alarms.

Enter the above code and press the ENTER button. The Sounder Status LED will pulse slowly. Zone Fault/ Disabled/Test LEDs will show their current status (see below) with Zone 1 pulsing to indicate it is under selection.

Use Button 1 (Disable Mode) to move to the zone for programming (indicated by a pulsing LED) and press the ENTER button to change the status. Pressing the ENTER button again will toggle the status, indicated by a rapid or slow pulsing LED (see below). Then use Button 1 to move to the next zone. If the zone has been set to not resound alarms, the LED will be off. If kept as default, new fire condition will resound alarms, then the LED will be on steady.

**Rapid Pulse** = Zone is under selection and is set to have alarms resound (default).

**Slow Pulse** = Zone is under selection and has been set to not resound alarms on new fire condition.

**LED Off** = Zone has been set to not resound alarms on new fire condition.

**LED On** = Zone is set to have alarms resound (default).

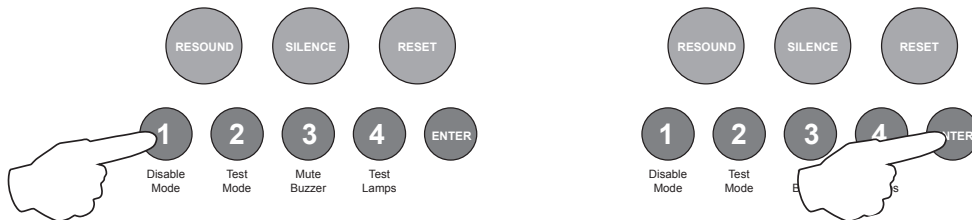

When finished, press and hold Button 1 (Disable Mode) for 3 seconds or alternatively wait approx 10 seconds and the panel will save the settings and revert back to Level 3 access mode.

Enter the next programming code or disable the controls and return DIL switch 3 to 'OFF'.

## 3 1 2 1 Zone Function Settings

There are 4 functional settings available for each zone. These are as follows:

### Fire latching

Normally a zone latches a fire input signal. This setting allows the panel to clear automatically when a fire signal is removed. This is useful for interfacing purposes.

### Short circuit as alarm (EN54!)

For Older non EN54 or BS5839 compliant systems. This allows a short circuit to activate a fire rather than a fault condition.

### Intrinsically safe operation

This option changes the zone alarm and short circuit thresholds to allow for an MTL 5061 type intrinsically safe barrier to be used in the circuit.

*Note: Twin Wire mode is not compatible with intrinsically safe operation.*

### Detector removal monitoring (EN54!)

The detector removal monitoring can be turned off. For use with older, non compliant detectors.

Enter the above code and press the ENTER button.

The zone 1 fire LED will light. This indicates setting the above attributes for zone 1.

The amber, fault / disabled / test LEDs will show the current settings for that zone.

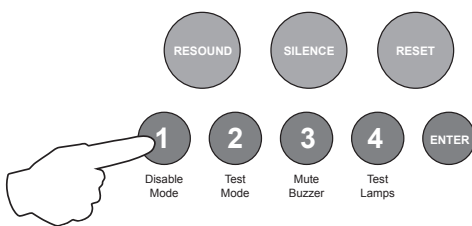
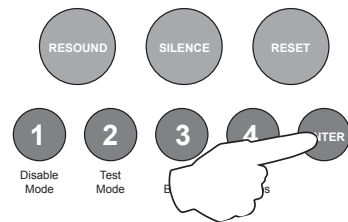

Use button 1 to move to the zone that requires editing.

With the required zone for editing LED lit, press the ENTER button to enter 'editing mode'.

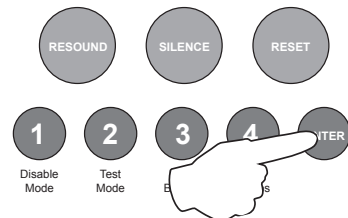

The fire zone 1 LED will now pulse to indicate the editing of attribute 1 (fire latching) for the selected zone.

Use button 1 to scroll to the attribute that requires editing, indicated by a pulsing fire LED 1 - 4 as per table below.

Fire LED (pulsing)	LED 1	LED 2	LED 3	LED 4
Attribute	Fire latching	Short circuit as fire	Intrinsically safe operation	Detector removal monitoring
Amber fault LED (default setting)	ON	OFF	OFF	ON

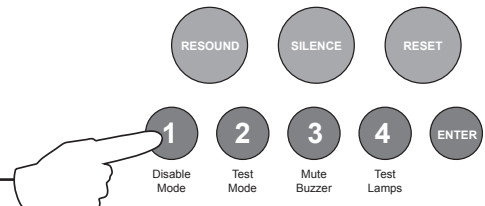

The setting of the attribute is indicated by the amber, fault / disabled / test LED, ON or OFF.

Use button 2 to switch the attribute ON or OFF, indicated by the amber, fault / disabled / test LED.

Then use button 1 to move to the next attribute if required.

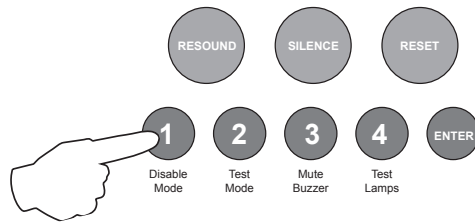
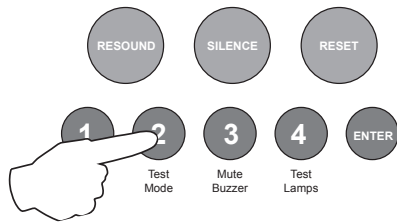

Press the ENTER button to return back to the zone selection, indicated by a steady zone fire LED

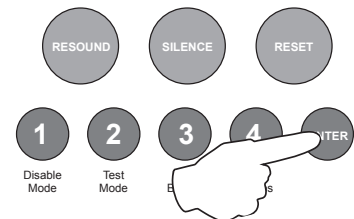

When finished all the zone function programming, enter the next programming code or disable the controls and return DIL switch 3 to 'OFF'.

② ① ① ④ **Type 'A' dependency mode.**

Dependency 'A' (confirmation alarm) is a requirement by some monitoring stations and local fire authorities to reduce the possibility of false alarms.

Dependency 'A' zones will apply the following sequence:

1. The first detector alarm is inhibited.
2. The panel resets and re-checks the inhibited zone within 15-30 seconds.
3. If an alarm is detected then the panel activates a full fire condition.
4. If no alarm is detected, the panel stays in an alert condition for 30 minutes. Any new alarm from the same zone within this time activates a full fire condition.
5. After 30 minutes or if RESET, the panel reverts to step 1.

**Note:** 220Ω 'Evacuate' call points should be used on such zones to provide an instant un-delayed alarm. A 470Ω call point will be included in the dependency delay sequence.

By default this is set to 'off' for all zones.

To set zones to Type 'A' Dependency, enter the above code and press the ENTER button. The Aux Output Status LED will pulse slowly. Zone Fault/Disabled/Test LEDs will show their current status (see below) with Zone 1 pulsing to indicate it is under selection.

Use Button 1 (Disable Mode) to move to the zone for programming (indicated by a pulsing LED) and press the ENTER button to change the status. Pressing the ENTER button again will toggle the status, indicated by a rapid or slow pulsing LED (see below). Then use Button 1 to move to the next zone. If the zone has been set to confirmation alarm mode, the LED will remain on. If kept as standard alarm mode then the LED will be off.

**Slow Pulse** = Zone is under selection and is set to standard alarm mode.

**Rapid Pulse** = Zone is under selection and has been set to confirmation alarm mode.

**LED Off** = Zone is set to standard alarm mode.

**LED On** = Zone has been set to confirmation alarm mode.

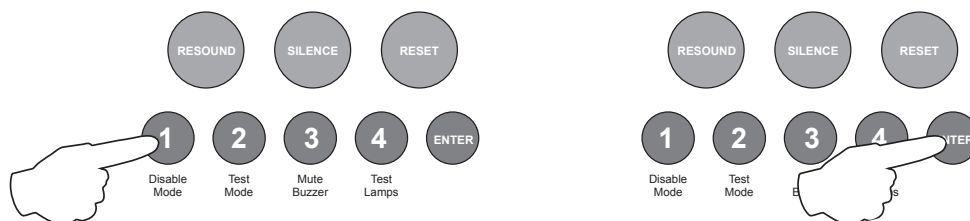

When finished, press and hold Button 1 (Disable Mode) for 3 seconds or alternatively wait approx 10 seconds and the panel will save the settings and revert back to Level 3 access mode.

Enter the next programming code or disable the controls and return DIL switch 3 to 'OFF'.



**2 1 3 4 Dependency mode Twin Wire detector compatibility**

If using dependency mode, Eclipse panels are designed to work with the following conventional detectors:-

- Apollo Series 65
- Apollo Orbis
- Hochiki CDX
- Nittan Evolution Conventional

However, if also using **Twin Wire** mode the panels are optimised for use with Apollo Series 65 heads & 45681-206 Sav-Wire bases.

In order for the other three detector types; Apollo Orbis, Hochiki CDX & Nittan Evolution Conventional to be used with their relevant Sav-Wire bases the above compatibility mode must be switched on.

Enter the code: 2 - 1 - 3 - 4. Zone 1 fire LED will pulse. Pressing the ENTER button will illuminate zone 1 Fault/Disabled/Test LED indicating that the compatibility mode is set to on,

Pressing the ENTER button again will toggle the compatibility mode on & off, indicated by the zone 1 Fault/Disabled/Test LED.

When finished, press and hold Button 1 (Disable Mode) for 3 seconds or alternatively wait approx 10 seconds and the panel will save the settings and revert back to Level 3 access mode.

Enter the next programming code or disable the controls and return DIL switch 3 to 'OFF'.

**N.B.**

**The above setting is only relevant if you are using Dependency mode & Twin Wire mode but NOT using Apollo Series 65 detectors.**

4 2 4 2 **Common fire outputs cancel on silence alarms**

The Common Fire VFCO relay output and the Common Fire switched -ve output, when activated, normally remain until the panel is RESET.

This option changes these outputs to reset on SILENCE ALARMS. This may be useful for panel interlink purposes.

Both outputs can be programmed independently.

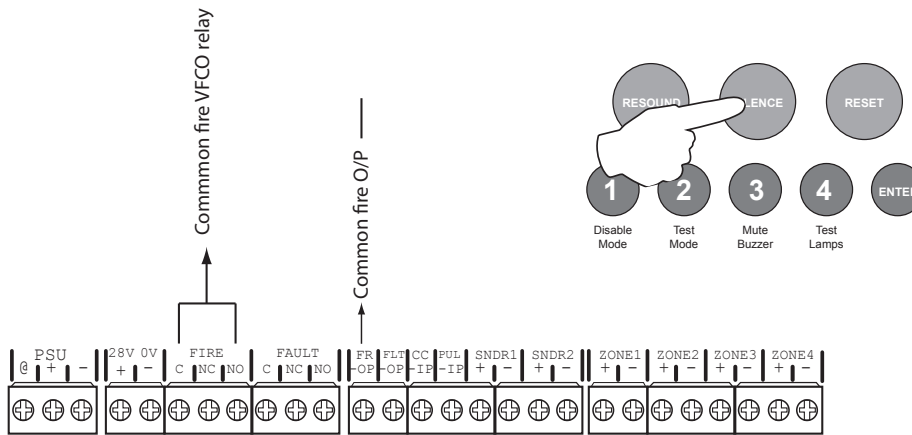

Enter the above code and press the ENTER button.

The red Zone 1 fire LED will illuminate, this LED represents the Common Fire VFCO relay output.

Pressing Button 1 (Disable Mode) will move to red Zone 2 fire LED which represents the Common Fire switched -ve output. Subsequent presses will toggle between them.

With the required fire LED lit press the ENTER button and Zone 1, fire LED will pulse.

Press button 2 (Test Mode) to alter the status of the output, represented by the Zone 1, Fault/Disabled/ Test LED either off or on.

- Off = Output cancels on RESET (factory default)**
- On = Output cancels on SILENCE ALARMS.**

When the output status has been set, press the ENTER button to return to the output selection mode.

When finished, press and hold Button 1 (Disable Mode) for 3 seconds or alternatively wait approx 10 seconds and the panel will save the settings and revert back to Level 3 access mode.

Enter the next programming code or disable the controls and return DIL switch 3 to 'OFF'.

④ ③ ④ ④ **Conventional sounder circuit functional options**

This option is used to programme each of the conventional sounder circuits on the main circuit board with custom responses as below.

Enter the above code and press ENTER. Then use button 1 to select the sounder circuit to be programmed (indicated by a steady fire zone LED) as per table.

LED 1	LED 2
SNDR1 (Main PCB)	SNDR2 (Main PCB)

With the required sounder LED lit, press the ENTER button. Fire zone LED 1 will now pulse. This indicates setting up function 1 (resets on silence alarms) for the selected circuit. Use button 1 to scroll to the required function, indicated by pulsing fire LEDs 1- 4 as per table below.

Fire LED (pulsing)	LED 1	LED 2	LED 3	LED 4
<b>Function</b>	Resets on Silence Alarms	Activates on Evacuate	Activates on Class Change	Activates on Alert
<b>Amber fault LED (default setting)</b>	OFF	ON	OFF	OFF

Use button 2 to change the response to ON or OFF, indicated by the amber fault LEDs.

Then use button 1 again to scroll to the next function if required.

Press the ENTER button to return back to sounder circuit selection, indicated by a steady fire LED.

**ZONE INTERFACE FUNCTION**

This is a special setting to configure the last zone on the panel, (i.e. zone 2 on the ECL-2 or zone 4 on the ECL-4), to be used for interconnection from other control panels.

The function is enabled by setting switch 2 on the 3 way DIL switch located on the main PCB to the 'ON' position.

With switch 2 in the 'ON' position, the last zone becomes;

1. Non latching &
2. Non aux operating.

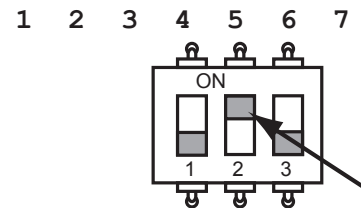

**Note:**

If the control panel is also set to Twin Wire mode (Switch 1 'ON') and sounders are connected to the interface zone circuit, the following sounder operation will apply:

A fire (470Ω) signal to the interface zone will **NOT** operate the sounders connected to that Twin Wire circuit. All other conventional (SNDR1 & SNDR2) and Twin Wire zone sounders will operate as normal.

A fire (470Ω) signal to any other zone will operate **ALL** conventional (SNDR1 & SNDR2) and Twin Wire sounder circuits, including the sounders connected to the interface zone, as normal.

*Example connection*

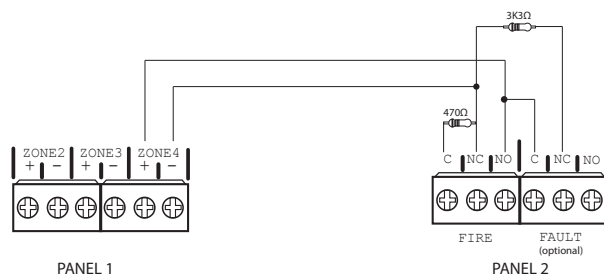

PANEL CONTROLS & INDICATIONS

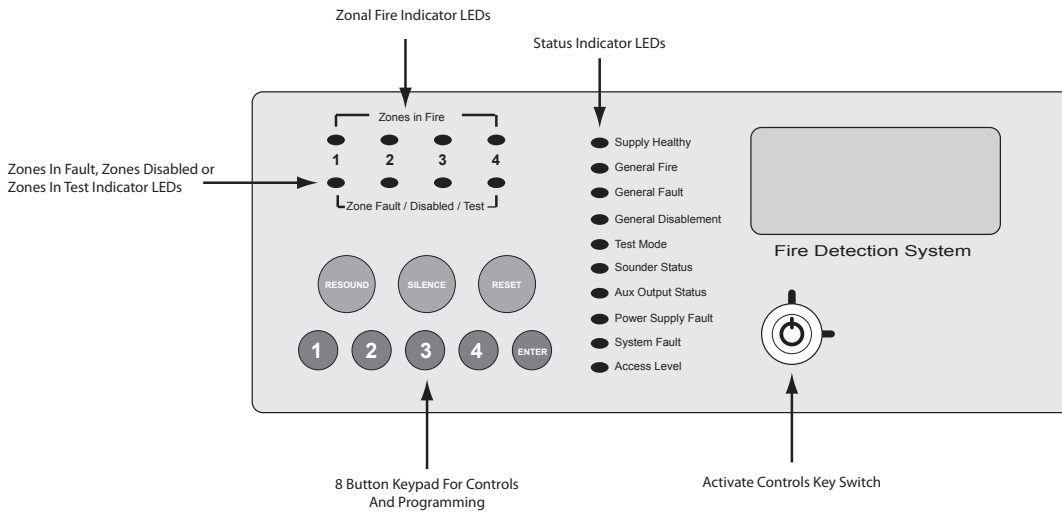

Activate Controls

In normal standby mode the keypad controls are inactive to protect from unauthorised operation. Controls can be activated by using the 'Activate Controls' key switch or by entering a four digit code using the keypad.

The use of a code entry to activate the controls is enabled by default but can be disabled in the engineering functions.

**To activate the controls using the key switch;** turn the key clockwise to the 'On' position. The 'Access Level' indicator LED will light and all buttons on the keypad will now be operational. To deactivate the controls, turn the key back to the 'Off' position and the 'Access Level' indicator LED will extinguish.

If the key switch is in the 'On' position the keypad will remain active.

**NOTE :** It is not possible to remove the key in the 'On' position.

**To activate the controls using the keypad;** enter the four digit code using buttons 1 - 4. The factory default code is 1-2-3-4 but can be changed in the engineering functions. After entering the four digit code press the 'ENTER' button. The 'Access Level' indicator LED will light and all buttons on the keypad will now be operational.

After activation by code entry, controls will automatically deactivate again after 2 minutes and the panel will return to standby mode.

The test lamps and mute buzzer functions are operational without the need to activate controls.

**Status LED Indicators**

	<b>LED On</b>	<b>LED Pulsing</b>
<b>Zones in Fire 1 - 4</b>	N/A	Indicates alarm condition in zone.
<b>Zone Fault/Disabled/Test 1 - 4</b>	Indicates zone circuit is disabled or in test mode.	Indicates a fault in the zone circuit.
<b>Supply Healthy:</b>	Indicates mains and/or battery supply is present.	N/A
<b>General Fire:</b>	N/A	Indicates panel is in alarm condition.
<b>General Fault:</b>	N/A	Indicates one or more faults are present.
<b>General Disablement:</b>	Indicates one or more circuits have been disabled.	Indicates disablement selection mode is active.
<b>Test Mode:</b>	Indicates one or more circuits are in test mode	Indicates test mode selection is active.
<b>Sounder Status:</b>	Indicates sounder circuits have been disabled or are in test mode	Indicates a fault on one or more sounder circuits.
<b>Aux Output Status:</b>	Indicates auxiliary outputs have been disabled.	N/A
<b>Power Supply Fault:</b>	N/A	Indicates a power supply or battery fault.
<b>System Fault:</b>	Indicates a system failure, panel not functional.	Indicates the panel has recovered from a system fault.
<b>Access Level:</b>	Indicates controls are active (access level 2).	Indicates panel is in configuration mode (access level 3).

**Keypad**

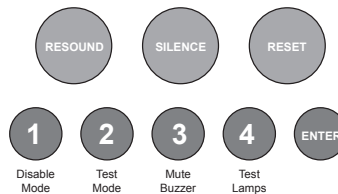

<b>RESOUND (red):</b>	Use to resound the alarms after they have been silenced. Can also be used to invoke full evacuation.
<b>SILENCE (blue):</b>	Use to silence the sounders during an alarm condition.
<b>RESET (green):</b>	Resets the panel back to standby mode.
<b>1: (Disable Mode)</b>	With controls inactive, use to initialise code entry mode for activation of controls. With controls active, use to disable zones, sounder circuits or aux outputs (see DISABLE MODE section). Also has the numeric value 1 for code entry.
<b>2: (Test Mode)</b>	With controls inactive, use to initialise code entry mode for activation of controls. With controls active, use to put zones or sounders circuits into test mode (see TEST MODE section). Also has the numeric value 2 for code entry.
<b>3: (Mute Buzzer)</b>	Mutes the panels internal fire and fault buzzer. (The buzzer will still blip every 5-6 seconds during a fire or fault condition). This function is operational without the need to activate controls. Also has the numeric value 3 for code entry.
<b>4: (Test Lamps &amp; Buzzer)</b>	Use this button to illuminate all LEDs and sound the internal buzzer to check that they are working correctly. This function is operational without the need to activate controls. Also has the numeric value 4 for code entry.
<b>ENTER:</b>	This button is used to confirm code entries. It can also be used for fault diagnosis (see FAULT DIAGNOSIS section).

Some buttons have other functions within the engineering facilities. These functions are described in the relevant sections.

## DISABLE MODE

Disable Mode is used to disable or isolate individual zone circuits or all sounder circuits or all auxiliary outputs.

To initialise Disable Mode, firstly activate the controls by turning the key switch or by entering the four digit code. Then press and hold the Disable Mode button (1) for 3 seconds.

After 3 seconds the panel will bleep and the General Disablement LED and Zone 1 Fault/Disabled/Test LED will pulse slowly, indicating that Zone 1 is in disable selection mode.

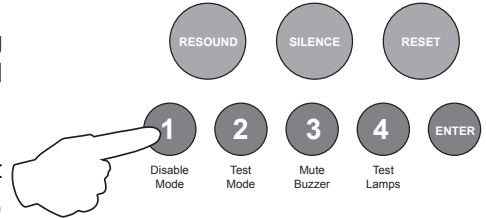

Pressing the Disable Mode button again will move disable selection mode to Zone 2 and the Zone 2 Fault/Disabled/Test LED will be pulsing instead. Subsequent presses will move the selection to Zones 3 and 4.

After Zone 4 the next press will move the selection mode to the sounder circuits, indicated by the Sounder Status LED and then to the Aux outputs, indicated by the Aux Output Status LED. Pressing the button once more will move the selection back to Zone 1 again.

When the desired circuit or output to be disabled is indicated by a slow pulsing LED, use the ENTER button to select it. Once selected the indicator LED will change to a rapid pulse. Pressing ENTER again will toggle the circuit between disabled and enabled. Then use Disable Mode button again to move to the next circuit. Any or all circuits can be disabled simultaneously.

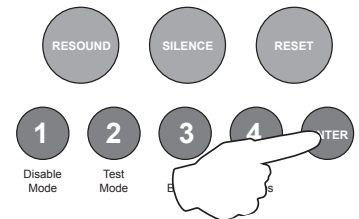

When all disablements have been set, press and hold the Disable Mode button for 3 seconds again. This will exit the disable selection mode and the panel will return to standby. All disabled circuits and the General Disablement will now be indicated by a steady LED.

To enable the circuits again, repeat the above process using the Disable Mode button to select the circuit and the ENTER button to remove the disablement.

### Tip:

With the controls active, pressing the Disable Mode button briefly will reveal which circuits are disabled (as opposed to in test mode). This is useful if using Disable Mode and Test Mode at the same time.

**TEST MODE**

Test Mode is used when testing the fire alarm system. In test mode the devices in the zone(s) in test, detectors and call points etc, can be activated and the panel will automatically reset, enabling the system to be tested by one person. It is possible to test head removal monitoring and to test the system with or without the sounders.

To initialise Test Mode, firstly activate the controls by turning the key switch or by entering the four digit code. Then press and hold the Test Mode button (2) for 3 seconds.

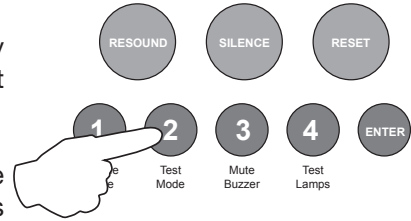

After 3 seconds the panel will bleep and the Test Mode LED and Zone 1 Fault/Disabled/Test LED will pulse slowly, indicating that Zone 1 is in test selection mode. The Sounder Status LED will also be pulsing rapidly, this indicates that the test will be **with** sounders. (Test mode without sounders is explained below)

Pressing the Test Mode button again will move test selection mode to Zone 2 and the Zone 2 Fault/Disabled/Test LED will be pulsing instead. Subsequent presses will move the selection to Zones 3 and 4.

After Zone 4 the next press will move the selection mode to the sounder circuits, indicated by no Zone Fault/Disabled/Test LEDs on. This position selects whether or not the sounders will ring during test. Pressing the button once more will move the selection back to Zone 1 again.

When the desired zone to be tested is indicated by a slow pulsing LED, use the ENTER button to select it. Once selected the indicator LED will change to a rapid pulse. Pressing ENTER again will toggle the zone between in and out of test. Then use Test Mode button again to move to the next zone. Any or all zones can be in test mode simultaneously.

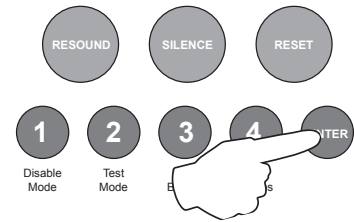

When at the sounder status position, use the ENTER button to toggle between testing with or without sounders. A rapid pulse = with sounders (default), a slow pulse = without sounders.

When all zones to be tested have been set, press and hold the Test Mode button for 3 seconds again. This will exit the test selection mode. All zones in test and the Test Mode will now be indicated by a steady LED.

To take zones out of test mode, repeat the above process using the Test Mode button to select the zone and the ENTER button to change the status.

**Test Mode With Sounders**

Activation of a call point or detector - sounders will pulse twice, device is automatically reset.  
Removal of a detector - sounders will pulse once.

**Test Mode Without Sounders**

Activation of a call point or detector - panel buzzer and LED response only, device is automatically reset.

**Tip:**

With the controls active, pressing the Test Mode button briefly will reveal which circuits are in test mode (as opposed to disabled). This is useful if using Disable Mode and Test Mode at the same time.

## FAULT DIAGNOSIS

If the panel has detected a fault on the system the General Fault LED will be illuminated and the internal fault buzzer will sound. Secondary LEDs will also be illuminated depending on the location of the fault.

Pressing and holding the ENTER button will reveal more detailed information about the location and type of fault.

This function will not work if the panel is in a fire condition. If no faults exist pressing the ENTER button will have no effect.

This function is only operational when controls are not active.

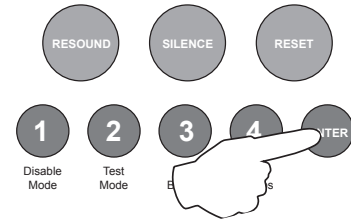

The following table shows details of the indications in fault diagnosis mode:

LED Indicator & State before pressing ENTER	LED Pulsing after pressing ENTER	LED Steady after pressing ENTER	LED Off after pressing ENTER	Location
Zone 1 Fire LED (off)	Sounder circuit 1 short circuit	Sounder circuit 1 open circuit	OK	Main PCB SNDR 1
Zone 2 Fire LED (off)	Sounder circuit 2 short circuit	Sounder circuit 2 open circuit	OK	Main PCB SNDR 2
Zone 1 - 4 Fault/ Disabled/Test LED (pulsing)	Zone # short circuit	Zone # open circuit	(slow pulse) Zone # detector removed	Main PCB Zones 1 - 4
Zone 1 - 4 Fault/ Disabled/Test LED (steady)	N/A	N/A	Zone # disabled or in test mode	
Power Supply Fault LED (pulsing)	Mains failure	Battery failure or high impedance	Voltage fault	Main PCB



**FUNCTIONALITY DURING A SYSTEM FAULT**

A system fault is indicated when a processor controlling a function in the panel has a watchdog time out or processor failure. In the event of a system fault the particular board affected may not be functional. The following indications may be observed.

**Display Board**

System Fault LED only continuous and continuous buzzer sound. Display board TPCA02 is halted and no other indication or control is possible. Fault relay and fault output are activated. If a fire occurs alarm sounders and outputs will still function.

**Main Board**

System Fault LED continuous and General Fault LED pulsing and continuous buzzer sound. Main board is halted. Fault relay is activated. No alarms may be activated on the system.

**System Fault recovery**

System Fault LED pulsing and General Fault LED pulsing along with a pulsed buzzer (fault tone) a system fault has occurred and the affected board has recovered. The indication will remain until the panel is reset.

**USER INSTRUCTIONS**

If an alarm condition is present YOU MUST FOLLOW YOUR NORMAL FIRE DRILL PROCEDURES.

A responsible person should then:-

1. Check the control panel to see which area or zone has caused the system to go into alarm. This will be indicated by a pulsing red LED on the front of the control panel.
2. Go to the area which has caused the alarm to check if a fire exists.
3. Only when it is safe to do so should the alarms be silenced. Activate the controls by turning the key switch or by entering the four digit code (see Activate Controls in the OPERATING section) and press the (blue) SILENCE ALARMS button (fig 1). To sound the alarms again press the (red) RESOUND button (fig 2).
4. In the event of a false alarm look for the device that has caused the alarm. A detector will have a red LED lit, or check to see if a call point glass is broken (if so replace the glass or call an engineer).
5. When fully satisfied that there is no fire, return to the control panel and press the (green) RESET button, (fig 3). The panel display should return to normal and only the green SUPPLY HEALTHY LED should be lit on the control panel.

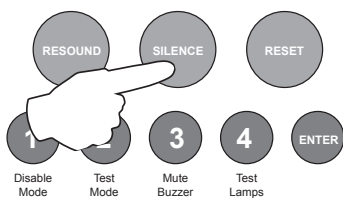

fig 1

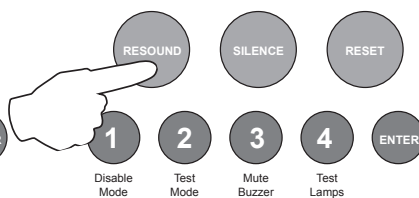

fig 2

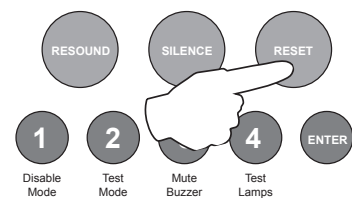

fig 3

**The following section is a summary of the requirements in BS5839 Part 1**

For comprehensive information a copy of BS5839 Part 1 can be purchased from the British Standards Institution via their web site at [www.bsi-global.com](http://www.bsi-global.com).

## THE NEED FOR MAINTENANCE

Your Fire Alarm System is working 24 hours a day, 365 days a year. The detectors and control & indicating panel are operating continuously and the fire alarm circuits are constantly monitored.

Legislation such as the Regulatory Reform (Fire Safety) Order 2005 and other legislation protecting both employees and the public require premises operators to conform with standards for Fire Alarm Systems.

It is a requirement of BS 5839 Part 1 that the system is subject to periodic inspection and servicing so that faults are identified, preventive measures can be taken to ensure the continued reliability of the system, false alarm problems are identified and suitably addressed, and the user is made aware of any changes to the building that affect the protection afforded by the system.

The inspection and servicing recommendations in this clause should be carried out by a competent person. A 'Competent Person' is a person or fire alarm servicing organisation with specialist knowledge of fire detection and fire alarm systems, including knowledge of the causes of false alarms, sufficient information regarding the system, and adequate access to spares.

The period between successive inspection and servicing visits should be based upon a risk assessment, taking into account the type of system installed, the environment in which it operates and other factors that may affect the long term operation of the system. The recommended period between successive inspection and servicing visits should not exceed six months. If this recommendation is not implemented, it should be considered that the system is no longer compliant with this part of BS 5839

## DUTIES OF THE RESPONSIBLE PERSON

The system user needs to appoint a single, named member of the premises management to supervise all matters pertaining to the fire detection and fire alarm system. The role of this person is to ensure that the system is tested and maintained in accordance with the recommendations of BS 5839 Part 1, that appropriate records are kept and that relevant occupants in the protected premises are aware of their roles and responsibilities in connection with the fire detection and fire alarm system.

This person also needs to ensure that necessary steps are taken to avoid situations that are detrimental to the standard of protection afforded by the system and to ensure that the level of false alarms is minimized.

## ROUTINE MAINTENANCE & TESTING

### DAILY

The 'Responsible Person' should check the control panel to make sure no faults or pre-alarm conditions are indicated and that the green 'Supply Healthy' lamp is lit.

### WEEKLY

The Fire Alarm System should be tested on a weekly basis as recommended in BS5839 Part 1 clause 44.2.

Every week a manual call point should be operated during normal working hours. The weekly test should be carried out at approximately the same time each week. Instructions to the occupants should be that they report any instance of poor audibility of the fire alarm signal.

A different manual call point should be used at the time of every weekly test so that all manual call points in the building are tested in rotation over a prolonged period.

The result of the weekly test and the identity or location of the manual call point used should be recorded in the system log book.

**WEEKLY TEST**

The call point test key should be inserted firmly and deliberately into the bottom of the manual call point. Once activated it may be necessary to wait up to four seconds before the alarms sound.

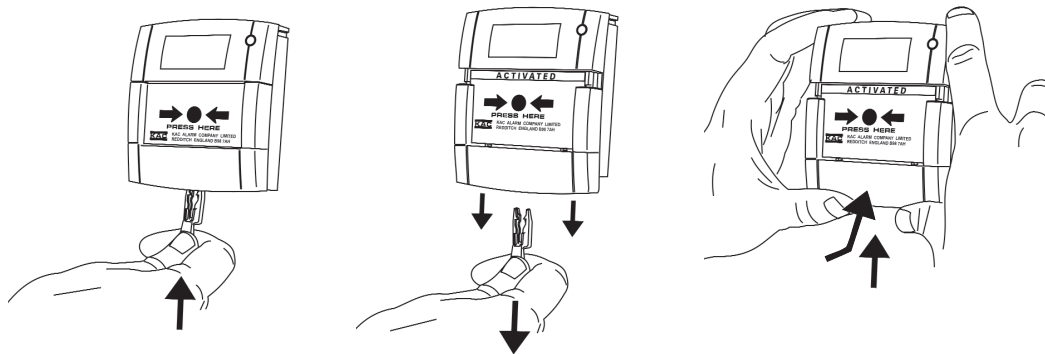

Your manual call points may not be the same as the ones described above. If not please refer to your service and maintenance company for instructions.

**Note:**

*Before testing the fire alarm system it may be necessary to isolate ancillary outputs.*

*It is essential that any alarm receiving centre is contacted immediately before and immediately after, the weekly test to ensure that unwanted alarms are avoided and that fire alarm signals are correctly received at the alarm receiving centre.*

**PERIODIC INSPECTION & SERVICING**

Inspection & servicing should only be carried out by a ‘Competent Person’ who has sufficient knowledge to check the whole system. This would normally be a qualified electrical contractor or fire alarm specialist.

Inspection & servicing visits are normally conducted on a quarterly basis unless such factors as a dirty environment warrant servicing on a more regular basis. The maximum period between inspections must not exceed six months.

**Recommendations of BS5839-1 for periodic service visits include:**

- Every device on the system should be tested annually. The testing of each device can be split between periodic visits but with a minimum of one detector or call point tested on each circuit, per visit.
- On each visit the ‘Competent Person’ should check the record of false alarms. Any persistent occurrence should be investigated and corrective action taken as appropriate.
- Battery and connections should be examined and load tested to check serviceable condition and that they are not likely to fail before the next service visit.
- All other devices and control & indicating equipment should be checked for correct operation and any faults should be recorded and rectified.
- Details of the service visit must be recorded in the log book

**EVERY FOUR YEARS**

Renew the sealed lead acid batteries and record the fact in the log book

# SCHEDULE OF TESTING

**This Section To Be Used To Record ALL Weekly Tests Of The Fire Alarm System**

DATE & TIME OF TEST	DEVICE TESTED & LOCATION	COMMENTS <i>(IF ANY)</i>	INITIALS OF TESTER

## SCHEDULE OF TESTING

This Section To Be Used To Record ALL Weekly Tests Of The Fire Alarm System

DATE & TIME OF TEST	DEVICE TESTED & LOCATION	COMMENTS (IF ANY)	INITIALS OF TESTER

# SCHEDULE OF TESTING

**This Section To Be Used To Record ALL Weekly Tests Of The Fire Alarm System**

DATE & TIME OF TEST	DEVICE TESTED & LOCATION	COMMENTS <i>(IF ANY)</i>	INITIALS OF TESTER

# SCHEDULE OF TESTING

This Section To Be Used To Record ALL Weekly Tests Of The Fire Alarm System

DATE & TIME OF TEST	DEVICE TESTED & LOCATION	COMMENTS <i>(IF ANY)</i>	INITIALS OF TESTER





## SCHEDULE OF TESTING

This Section To Be Used To Record ALL Weekly Tests Of The Fire Alarm System

DATE & TIME OF TEST	DEVICE TESTED & LOCATION	COMMENTS <i>(IF ANY)</i>	INITIALS OF TESTER

## FALSE ALARMS, FAULTS & ENGINEERS VISITS

Fault/Reason For Call-Out	Action Taken	Date	Work Completed	Engineer's Details

# FALSE ALARMS, FAULTS & ENGINEERS VISITS

Fault/Reason For Call-Out	Action Taken	Date	Work Completed	Engineer's Details

## FALSE ALARMS, FAULTS & ENGINEERS VISITS

Fault/Reason For Call-Out	Action Taken	Date	Work Completed	Engineer's Details

## USER INSTRUCTIONS

If an alarm condition is present YOU MUST FOLLOW YOUR NORMAL FIRE DRILL PROCEDURES.

A responsible person should then:-

1. Check the control panel to see which area or zone has caused the system to go into alarm. This will be indicated by a pulsing red LED on the front of the control panel.
2. Go to the area which has caused the alarm to check if a fire exists.
3. Only when it is safe to do so should the alarms be silenced. Activate the controls by turning the key switch or by entering the four digit code (see Activate Controls in the OPERATING section) and press the (blue) SILENCE ALARMS button (fig 1). To sound the alarms again press the (red) RESOUND button (fig 2).
4. In the event of a false alarm look for the device that has caused the alarm. A detector will have a red LED lit, or check to see if a call point glass is broken (if so replace the glass or call an engineer).
5. When fully satisfied that there is no fire, return to the control panel and press the (green) RESET button, (fig 3). The panel display should return to normal and only the green SUPPLY HEALTHY LED should be lit on the control panel.

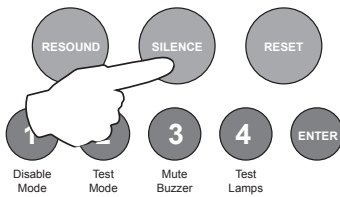

fig 1

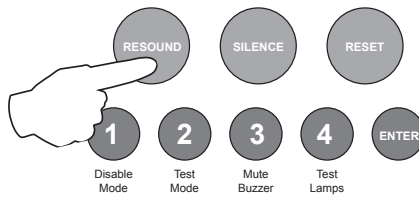

fig 2

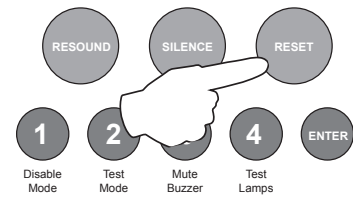

fig 3

**If the system continues to false alarm, call an engineer**

### Fault Condition

If a buzzer is sounding in the control panel but the sounders or bells are not ringing, then there is either a fault on the system, or zones / sounders have been disabled. CALL AN ENGINEER

**The internal fault buzzer can be silenced by pressing MUTE BUZZER (button 3 on the keypad). DO NOT RESET THE SYSTEM UNTIL AN ENGINEER HAS INVESTIGATED THE FAULT.**





[www.haes-tech.com](http://www.haes-tech.com)