

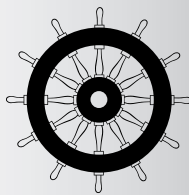

**MARINE APPROVED 8 - 12 ZONE CONVENTIONAL
CONTROL PANEL**

Installation, Commissioning & Operating Manual



MED Ref: 2831/15

Haes Technologies Ltd, Unit 3 Horton Industrial Park, West Drayton, UB7 8JD

Model Number

Esento Marine 8 zone conventional panel ESEN-8MAR

Esento Marine 12 zone conventional panel ESEN-12MAR

MED Ref No.

2831-MED-1086

2831-MED-1086

European Standard EN54-2 : 1997 + A1 : 2006
Control and indicating equipment for fire detection and fire alarm systems for buildings.

Provided Options (with requirements):
Output to fire alarm devices, dependency type 'A', test condition

European Standard EN54-4 : 1997 + A1 : 2002 + A2 : 2006
Power supply equipment for fire detection and fire alarm systems for buildings.

European Standard BS IEC60092-504 : 2001
Electrical installations in ships, special features, control and instrumentation.

European Standard BS IEC60533 : 1999
Electrical and electronic installations in ships, electromagnetic compatibility.

IMPORTANT NOTE

**PLEASE READ THIS MANUAL BEFORE HANDLING THE EQUIPMENT AND
OBSERVE ALL ADVICE GIVEN IN IT**

THIS PARTICULARLY APPLIES TO THE PRECAUTIONS NECESSARY TO AVOID

E.S.D

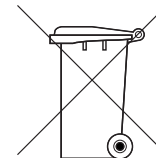

ATTENTION



IMPORTANT SAFETY NOTES

The panel is safe to operate provided it has been installed in compliance with the manufacturer's instructions and used in accordance with this manual.

Hazardous voltages are present inside the panel—DO NOT open it unless you are qualified and authorised to do so. There is no need to open the panel's enclosure except to carry out commissioning, maintenance and remedial work. This work must only be carried out by competent service personnel who are fully conversant with the contents of the panel's installation manual and have the necessary skills for maintaining this equipment.

This fire alarm system requires periodic checks as specified in BS 5839 Part 1 It is the responsibility of the system user to ensure it is regularly serviced and maintained in good working order.

Disclaimer

No responsibility can be accepted by the manufacturer or distributors of this fire alarm panel for any misinterpretation of an instruction or guidance note or for the compliance of the system as a whole. The manufacturer's policy is one of continuous improvement and we reserve the right to make changes to product specifications at our discretion and without prior notice. E & O E.

	Page
ABOUT THIS PANEL	2
PRODUCT OVERVIEW	2
CABINET DETAILS	3
CIRCUIT BOARDS	4
MAIN PCB TERMINALS	6
ZONE CARD TERMINALS	7
TECHNICAL SPECIFICATION	8
POWER SUPPLY MODULE	9
DESIGN CONSIDERATIONS	10
GENERAL DETECTION CIRCUIT SCHEMATIC	10
GENERAL SOUNDER CIRCUIT SCHEMATIC	11
INSTALLATION	12
SAFETY	12
ESD PRECAUTIONS	13
GENERAL	13
MOUNTING THE CABINET	13
MAINS CONNECTIONS	14
CONNECTING THE BATTERIES	15
SETUP & PROGRAMMING	16
NETWORK PANELS SETUP	16
LEVEL 3 ENGINEERING MODE	18
LEVEL 3 ENGINEERING OPTIONS INDEX	19
OPERATING	48
PANEL CONTROLS & INDICATIONS	48
DISABLE MODE	50
TEST MODE	51
FAULT DIAGNOSIS	52
FUNCTIONALITY DURING A SYSTEM FAULT	53
SERVICE & MAINTENANCE	54
DUTIES OF THE RESPONSIBLE PERSON	54
ROUTINE MAINTENANCE & TESTING	54
SCHEDULE OF TESTING LOG BOOK	56
FALSE ALARMS, FAULTS & ENGINEER VISIT LOG BOOK	60
USER INSTRUCTIONS	63

PRODUCT OVERVIEW

The Esento Marine 8 to 12 zone is a conventional control panel with integral power supply & space for standby batteries.

Esento Marine panels are fully approved to European standards EN54-2 & 4, Fire Detection and Alarm Systems – Control & Indicating Equipment.

The control panel comprises of a sheet steel enclosure suitable for wall mounting with a hinged, lockable front access door. It can be semi recessed, using a suitable recessing bezel. Cable entry is via 20mm ‘knockouts’ located at the top and rear of the cabinet.

An eight button keypad is used to control the system and allow access to the function options. The three main buttons, ‘RESOUND’ (red), ‘SILENCE’ (blue) and ‘RESET’ (green) being much larger and colour coded to assist the end users.

Eight or twelve fire zone circuits are provided plus four monitored sounder circuits. Fire & fault VFCO relays, fire & fault switched negative outputs, class change and an alert input are also included.

The panels are supplied with a 3.0 amp internal power supply module. This module complies with the requirements of EN54-4 : 1988 and provides temperature compensated battery management charging.

Quiescent and alarm current details for standby battery calculations

Models	Standby Current	Alarm Current
ESEN-8MAR	139mA	220mA
ESEN-12MAR	182mA	267mA
TPCA04-S 4 zone ext card, standard	43mA	47mA
TPCA04-H 4 zone ext card, high spec	49mA	87mA
TPCA05 comms card	5.2mA	N/A

CABINET

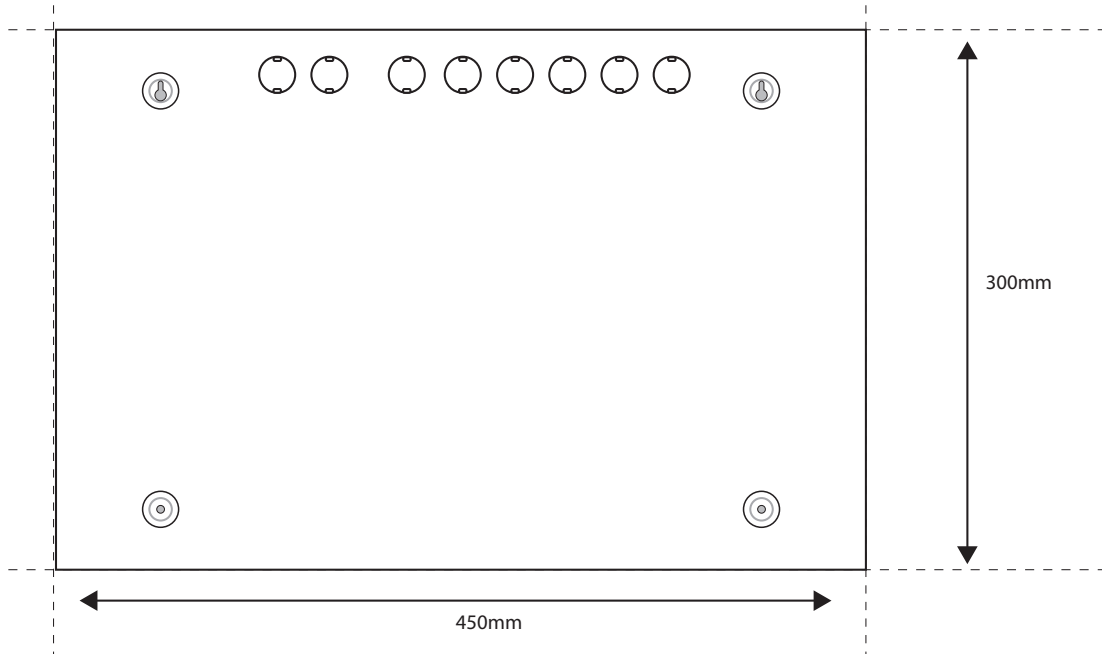
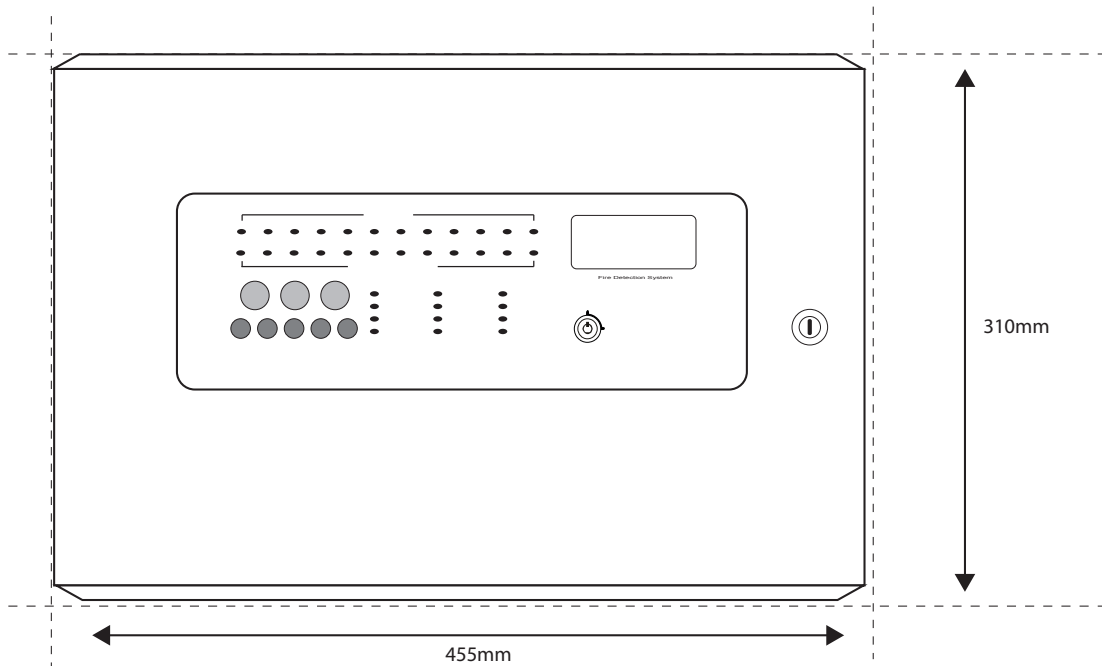
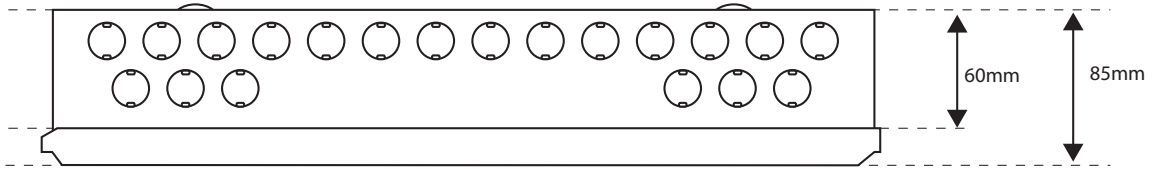

CIRCUIT BOARDS

Esento Marine 8-12 panels comprise of two main circuit boards plus optional ancillary boards

TPCA01-X2MAR/X4MAR - Master PCB

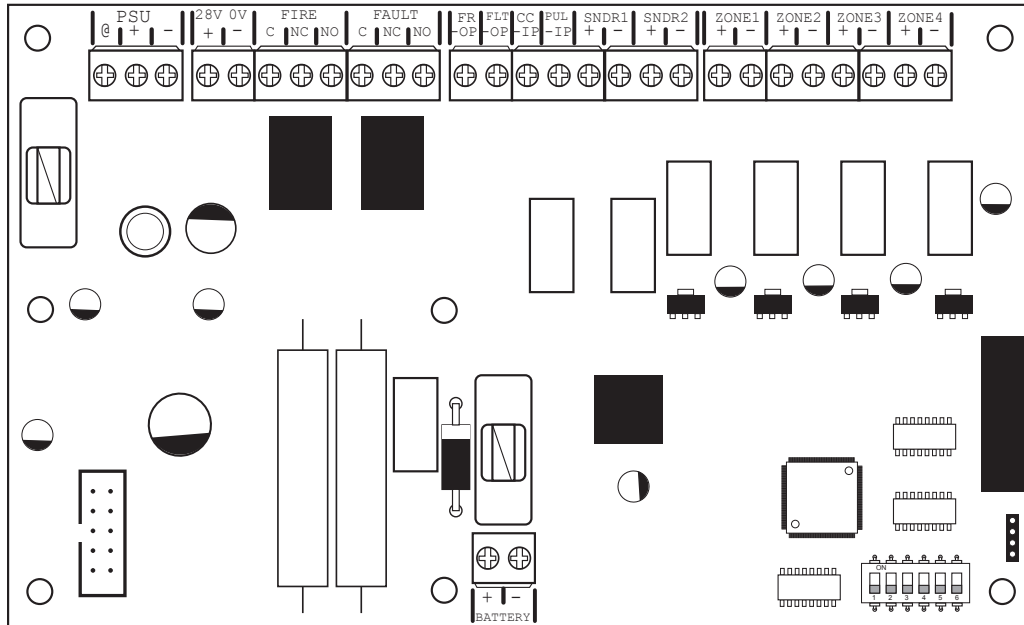

TPCA03 - LED Display & Controls PCB

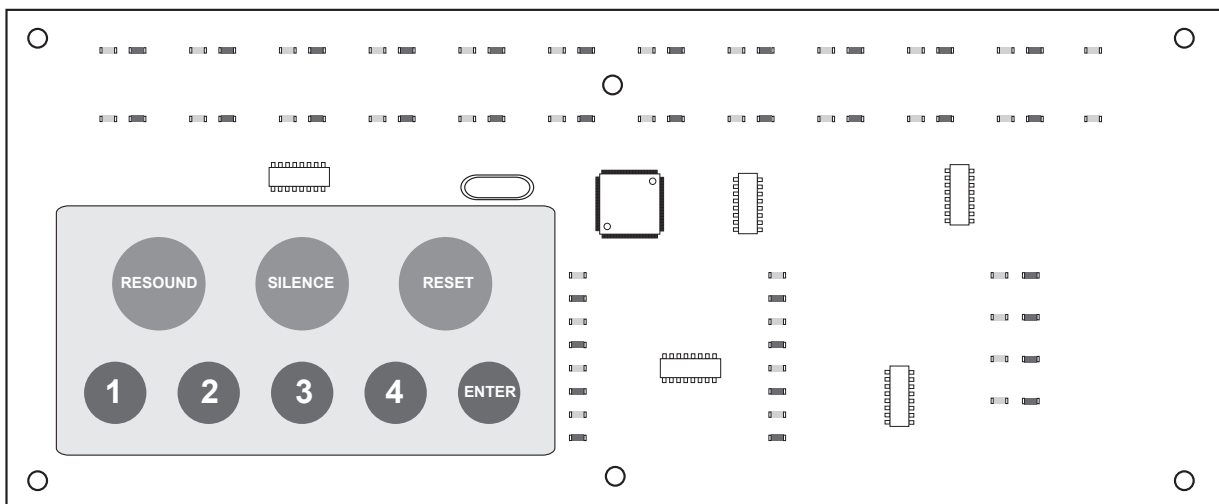

ANCILLARY CIRCUIT BOARDS

TPCA04-S - Std spec 4 zone extension card

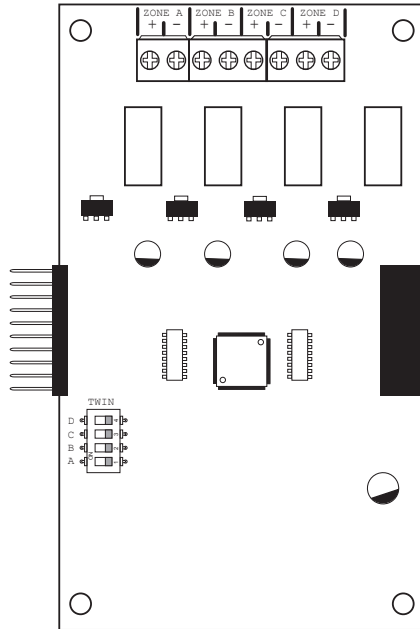

- 4 x conventional zone circuits.

TPCA04-H - High spec 4 zone extension card

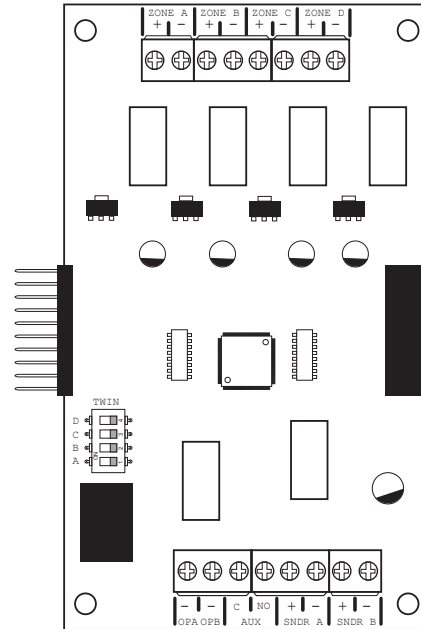

- 4 x conventional zone circuits.
- 2 x switched -ve outputs
- 1 x Aux relay output
- 2 x monitored sounder circuits

TPCA05 - Comms PCB

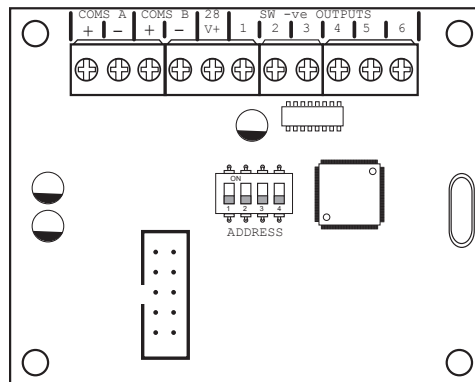

- Piggy backs on Main PCB for connection to network & repeater panels
- 6 programmable switch -ve outputs

MAIN PCB TERMINALS

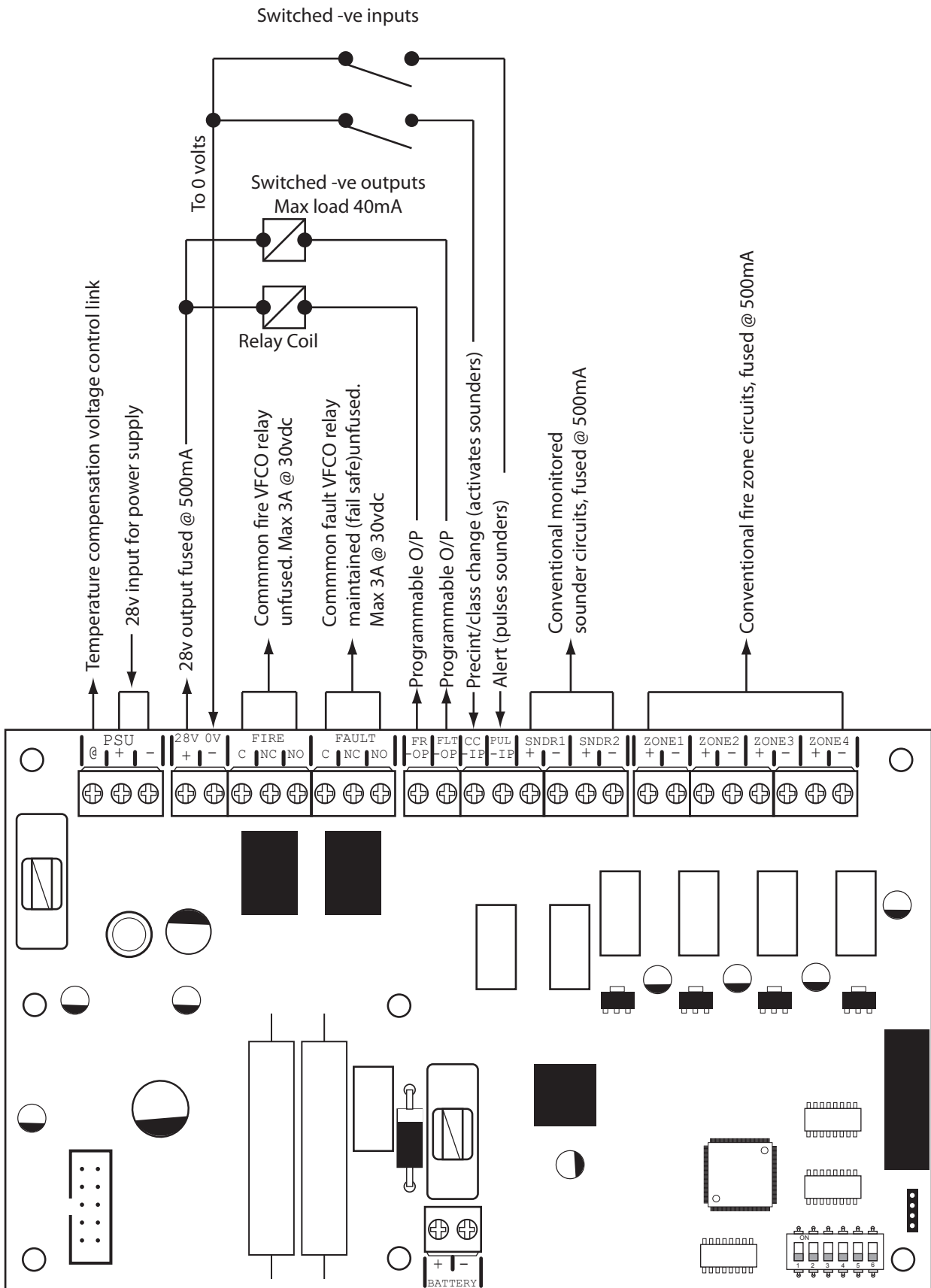

ZONE CARD TERMINALS

Drawing shows the high spec version of the zone extension PCB (TPCA04-H).

The std version does not contain the additional outputs or sounder circuits shown at the bottom.

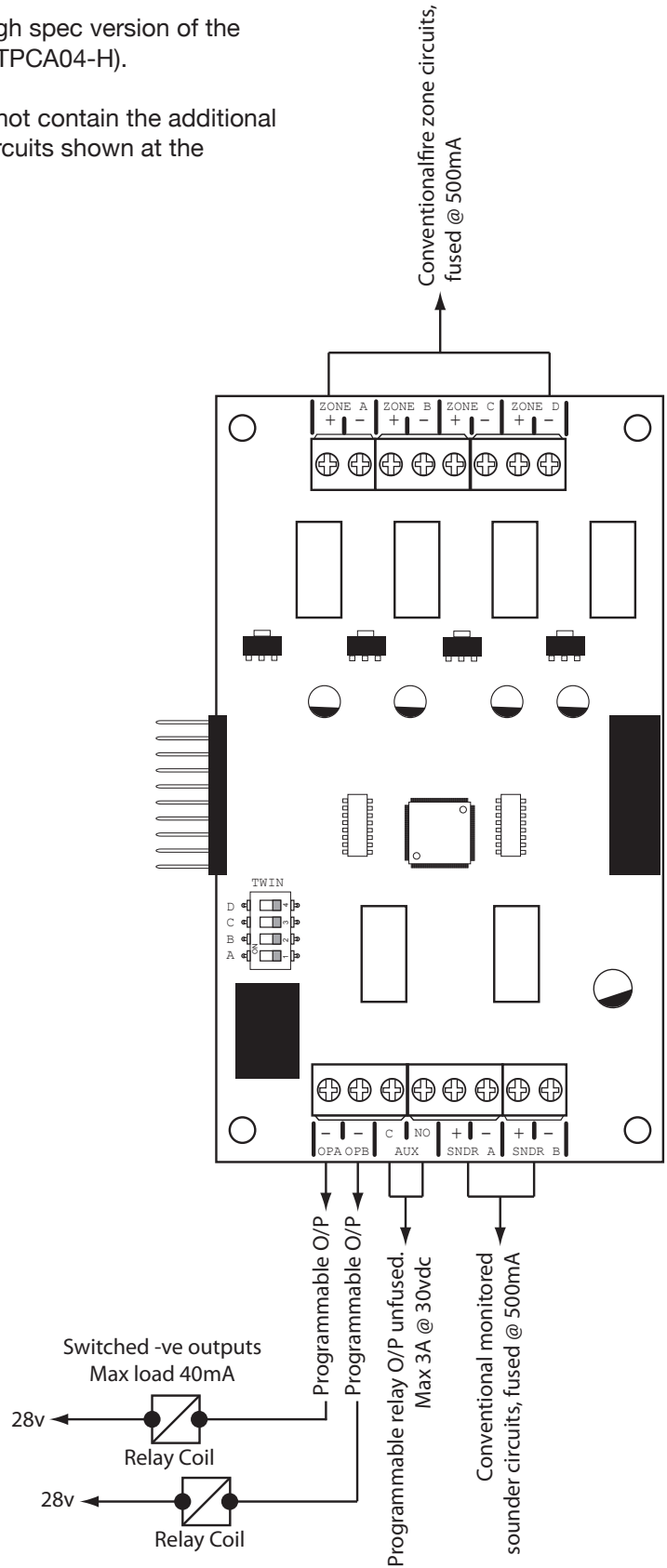

TECHNICAL SPECIFICATION

Electrical Specification Inputs & Outputs - TPCA01-X2/X4 Main PCB		
Terminal capacity	0.5mm ² to 2.5mm ² solid or stranded wire.	
PSU @ output	Power supply voltage control line.	For temperature compensation control.
PSU Input + -	28vdc supply input. Diode protected for reversal and independent short circuit. Max current 3 amps.	Max input current 3 amps. Input voltage 22vdc to 32vdc.
28v+, 0v- power output	28vdc supply output for fire alarm accessory relays etc. Max continuous use = 400mA.	Fused @ 500mA. Fuse = 500mA resettable fuse.
Common fire relay	Fire relay contact. Clean C/O. Max 3A @ 30vdc.	Unfused
Common fault relay	Maintained fault relay contact. Clean C/O Max 3A @ 30vdc.	Unfused
Outputs; FR, FLT	Switched -ve voltage outputs for relay control.	Overload voltage protected to 52vdc. Current limited 680R. Max load = 40mA
Inputs; CC, PUL	Switched -ve inputs, connect to 0v to trigger. Max input voltage = 28vdc. Non latching, max resistance 100R.	Protected via 10K Ohm impedance, 3v6 zener diode.
SNDR 1 - 2	28vdc polarity reversal monitored sounder outputs to fire alarm devices. 4K7 Ohm 5% 0.25W EOL resistor.	Monitoring current limit 28mA, fused @ 500mA. Typical max load 22 devices @ 18mA each per circuit. Ensure 2.4A is not exceeded.
Zone 1 - 4	Conventionally wired fire alarm zone circuits. 4K7 Ohm 5% 0.25W EOL resistor.	Maximum detector load 3.5mA per zone, Typical qty 40-50 Apollo marine optical detectors, Note:- Max 32 detectors with line continuity diode bases fitted

Electrical Specification Inputs & Outputs - TPCA04-S/H zone cards		
Terminal capacity	0.5mm ² to 2.5mm ² solid or stranded wire.	
Zone A - D	Conventionally wired fire alarm zone circuits. 4K7 Ohm 5% 0.25W EOL resistor.	Maximum detector load 3.5mA per zone, Typical qty 40-50 Apollo marine optical detectors, Note:- Max 32 detectors with line continuity diode bases fitted
Programmable outputs OP A & OP B	Switched -ve voltage outputs for relay control.	Overload voltage protected to 52vdc. Current limited 680R. Max load = 40mA
Programmable relay output	Fire relay contact. Clean C/O, C & N/O Max 3A @ 30vdc.	Unfused
SNDR A - B	28vdc polarity reversal monitored sounder outputs to fire alarm devices. 4K7 Ohm 5% 0.25W EOL resistor.	Monitoring current limit 28mA, fused @ 500mA. Typical max load 22 devices @ 18mA each per circuit. Ensure 2.4A is not exceeded.

Electrical Specification Inputs & Outputs - TPCA05 comms PCB		
Comms A - B	RS485	Repeater Comms, fused @ 20mA
28v	Supply output	Fused @ 500mA
Programmable outputs 1 - 6	Switched -ve outputs	Overload voltage protected to 52vdc Current limited 680R Max load = 40mA

General Specification	
Enclosure	Steel IP30. Epoxy powder coated Interpon Radon, silver grey
Cabling	Fire resistant screened cable, minimum size 1mm ² . Max cable length 1Km (20 Ohm), (max capacitance 1uF, max inductance 1 millihenry).
Temperature range	-5 deg C to +55 deg C max RH 95%
Vibration	IEC 60068-2-6 Test F
Inclination	IEC 60092-501 22.5°
Number of conventional/Twin Wire detection circuits	2 - 12
Detector compatibility	Apollo: S65, Orbis. / Hochiki CDX. / Nittan EV

POWER SUPPLY MODULE

Power Supply Specification		
Mains supply	230vac +10% / -15% 50Hz max current 1.2A	
Mains supply fuse	4 Amp (F4A 250V)	Not accessible for servicing. Internal to switch mode power unit
Internal power supply rating	3.0 Amps total including battery charging	Maximum load shared between outputs = 2.4A
Power supply output voltage	21.27 - 29.68vdc	Tolerance +/- 0.1%
Max continuous load (ImaxA). Max continuous load whilst battery charging is not required (ImaxB).	ImaxA = 610mA	ImaxB = ImaxA
Minimum current drawn by panel (example)	4 Zone I min = 90mA	12 Zone I min = 188mA
Maximum ripple	1.0V p-p	Supply and charger fault monitored
Min/max battery size and type	2 x 7.0Ah 12volt VRLA Use Yuasa NP range batteries	Batteries shall comply to BS 62368-1 requirements. Fire rated batteries shall be used.
Battery charging voltage	27.3 vdc nominal at 20 deg C	Temperature compensated
Battery charging output current	3.0A PSU 1.34A Current limited 4.7 Ohms	
Battery high impedance fault (Batt Hi Z)	Resistance = 1 Ohm or greater	1 hour reporting time
Max current drawn from batteries	3.15 Amps with main power source disconnected. Battery fuse 3.15A LBC 20mm.	

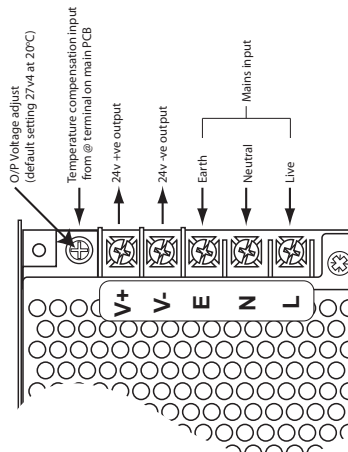

GENERAL DETECTION CIRCUIT SCHEMATIC

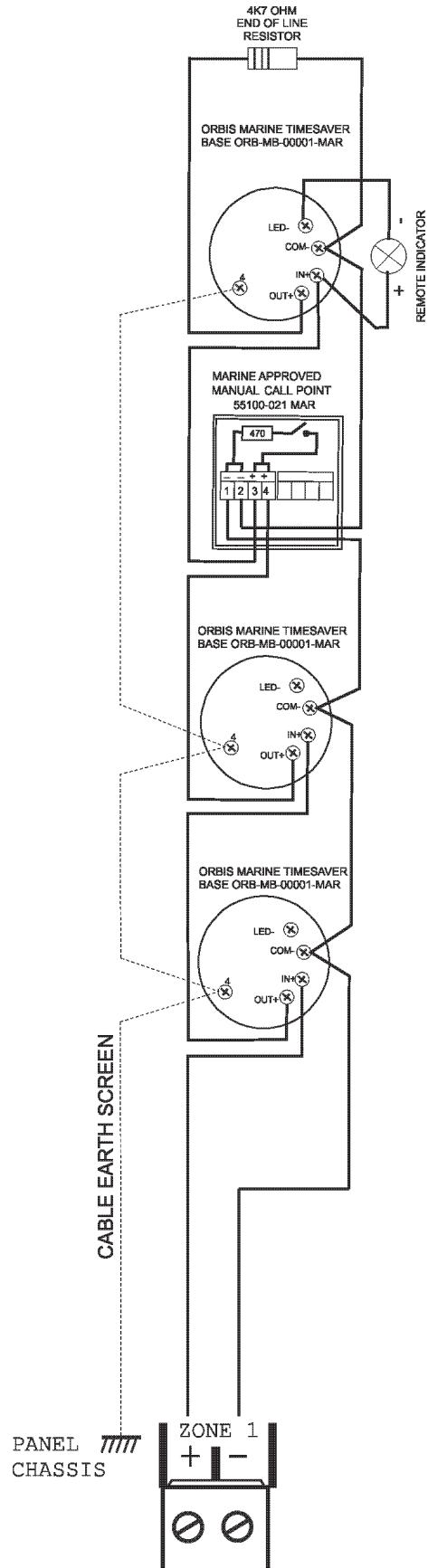

GENERAL SOUNDER CIRCUIT SCHEMATIC

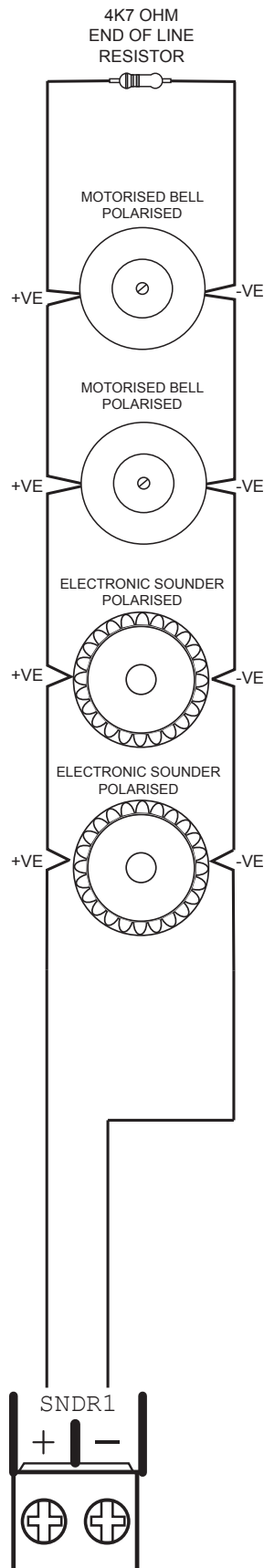

SAFETY

Suppliers of articles for use at work are required under section 6 of the Health and Safety at Work Act 1974 to ensure as reasonably as is practical that the article will be safe and without risk to health when properly used. An article is not regarded as properly used if it is used “without regard to any relevant information or advice” relating to its use made available by the supplier.

It is assumed that the system, of which this control panel is a part, has been designed by a competent fire alarm system designer in accordance with IMO FSS Code and with regard to BS EN 54 parts 2 and 4 in the case of control equipment and power supplies. Design drawings should be provided to clearly show the position of any field devices and ancillary equipment.

This product should be installed, commissioned and maintained by, or under the supervision of, competent persons according to good engineering practice and,

- (i) Codes of Practice
- (ii) Statutory requirements
- (iii) Any instructions specifically advised by the manufacturer

According to the provisions of the Code you are therefore requested to take such steps as are necessary to ensure that any appropriate information about this product is made available by you to anyone concerned with its use.

This equipment is designed to be operated from 230V AC 50/60 Hz mains supplies and is of Class I construction. As such it must be connected to a protective earthing conductor in the fixed wiring of the installation. Failure to ensure that all conductive accessible parts of this equipment are adequately bonded to the protective earth will render the equipment unsafe.

	<p>This equipment must only be installed and maintained by a suitably skilled and technically competent person.</p> <p>THIS IS A PIECE OF CLASS 1 EQUIPMENT AND MUST BE EARTHED</p>
---	--

These panels are designed to comply with the requirements of EN 54 part 2.

Installation of the panel should only be carried out by qualified personnel. The electronic components within the panel can be damaged by static charge. Suitable precautions must be taken when handling circuit boards. Never insert or remove boards or components, or connect cables, with the mains power on or batteries connected.

Equipment Guarantee	
<p>This equipment is not guaranteed unless the complete system is installed and commissioned in accordance with the laid down national standards by an approved and competent person or organisation.</p>	
	<p>This product has been manufactured in conformance with the requirements of all applicable EU Council Directives</p>

ESD PRECAUTION

Electronic components are vulnerable to damage by Electrostatic Discharges (ESD). An ESD wrist strap, suitably grounded, should be worn at all times when handling pcbs. These wrist straps are designed to prevent the build up of static charges, not only within a persons body, but on many other materials. ESD damage is not always evident immediately, faults can manifest themselves at anytime in the future. All pcbs should be stored in static shielded bags (silvered) for safe keeping, when not mounted in the control panel.

GENERAL

Care should be taken with regards to avoiding the close proximity of high voltage cables or areas likely to induce electrical interference. Earth links should be maintained on all system cables and grounded in the control panel. The detection and sounder circuit cabling is classed as extra low voltage and must be segregated away from mains voltage.

- Any junction boxes used should be clearly labelled FIRE ALARM.
- Any ancillary devices, e.g. door retaining magnets, must be powered from a separate power source.
- Any coils or solenoids used in the system must be suppressed, to avoid damage to the control equipment.

MOUNTING THE CABINET

The panel is only suitable for mounting in dry control rooms or dry accomodation spaces. The site chosen for the location of the panel should be clean, dry and not subject to shock or vibration. Damp, salt air or environments where water ingress or extremes of temperature may affect the panel must be avoided. The temperature should be in the range -5° to +55°C, and the relative humidity should not exceed 95%.

Before mounting the cabinet remove the main PCB.

Remove the power supply module connecting wires from the main PCB, taking care to note where to re-connect them. The main PCB can then be carefully pulled off it's mounting clips.

Secure the cabinet to the wall using the four indented holes in the back box. Ensure the box is mounted level and in a convenient location where it may be easily operated and serviced.

External cables should be glanded via preformed knockouts at the top and rear of the cabinet. Remove any knockouts and ensure the cabinet is clear of swarf etc prior to refitting the PCB. Always ensure that if a knockout is removed, the hole is filled with a good quality cable gland. Any unused knockouts must be securely blanked off.

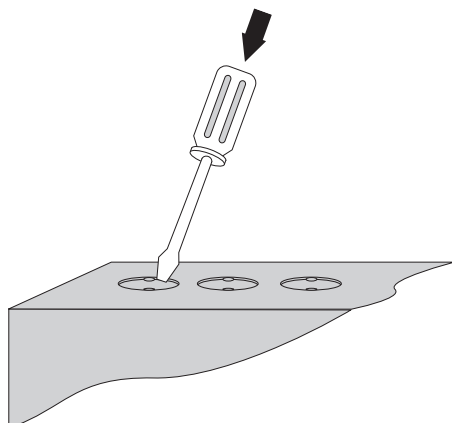

Knockouts should be removed with a sharp tap at the rim of the knockout using a flat 6mm broad bladed screwdriver.

Use of excessive force will damage the enclosure around the knockout.

Typical panel layout

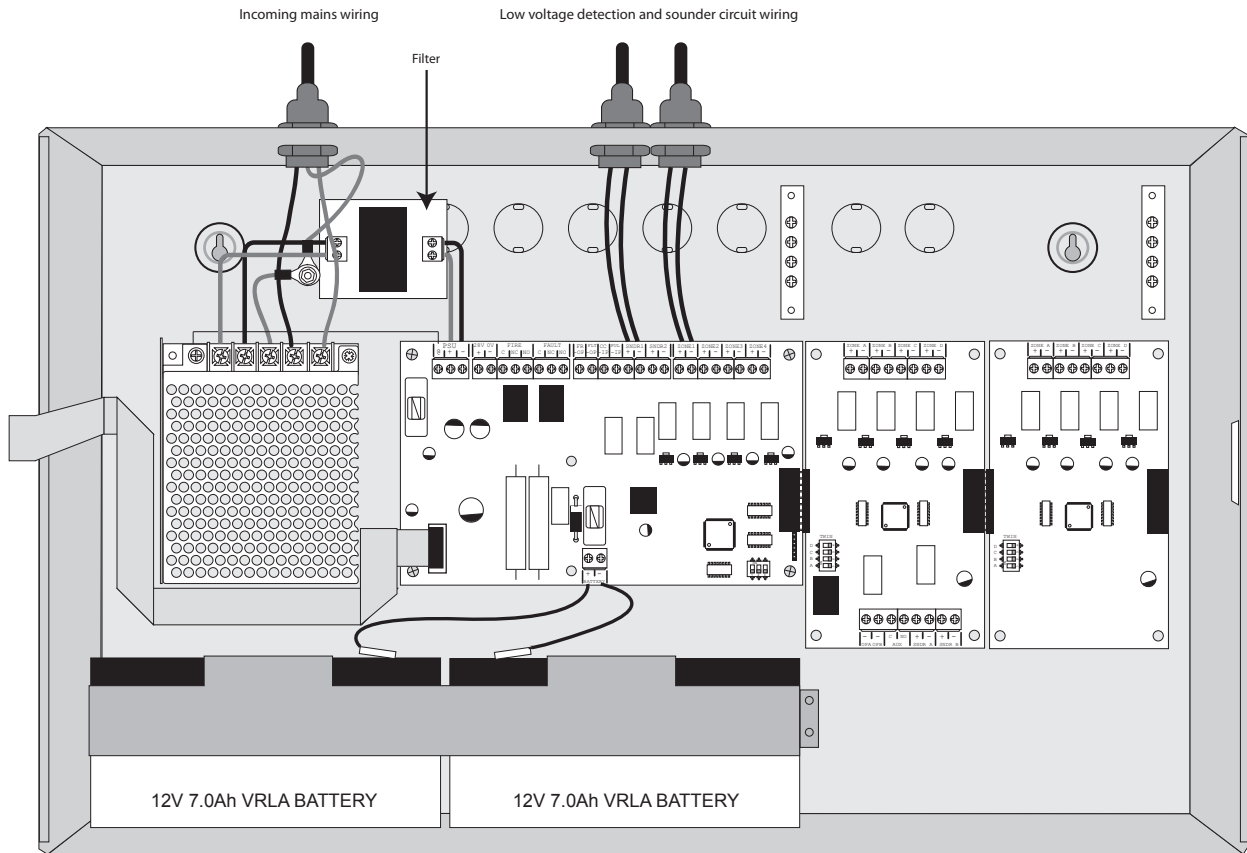

Drawing shows typical internal layout of a 12 zone panel with two 7.0Ah, 12v batteries fitted

MAINS CONNECTIONS

Do not connect the mains supply to the panel until you are fully conversant with the layout and features of the equipment.

A rating plate is attached to the power supply module describing the nature of the supply permitted.

The incoming mains supply should be brought into the panel via one of the knockouts provided.

A suitable cable gland must be used to secure the outer sheath of the cable used. The earth must first be connected to the primary earth stud (peg) marked with a  symbol, using a suitable ring crimp.

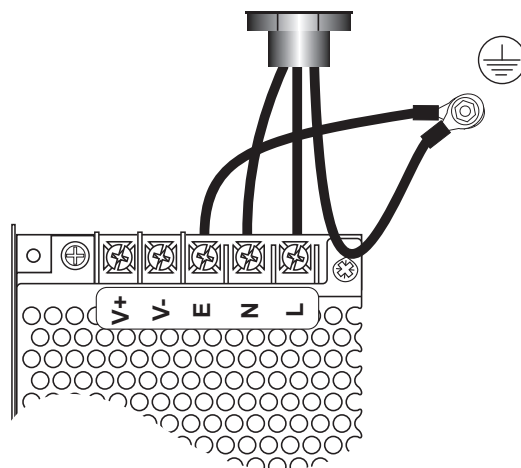

Sufficient earth lead should be left to allow Live and Neutral connections to be accidentally pulled from the terminal block while leaving the earth connection intact.

CONNECTING THE BATTERIES

Batteries of even very small capacity are capable of delivering very high currents which can cause fire or injury, therefore battery connections should be done with caution.

The panel is supplied with battery leads already connected to the battery terminals on the main PCB. These leads are coloured red for +ve and black for -ve.

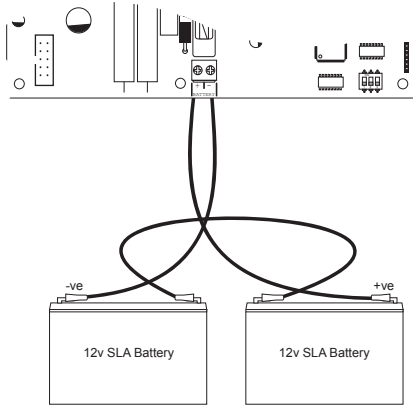

2 x 12v batteries should be connected in series using the white jumper lead provided. See diagram.

To optimise the service life of the batteries, the battery charger output voltage varies with temperature.

N.B.

In the event of mains failure, the battery charger circuit will protect the batteries from full discharge by disconnecting them when they reach below 19v. When the mains supply is restored the batteries will be automatically reconnected.

NOTE:

If the mains is connected before the batteries, the panel will show a Power Supply fault for up to 1 minute until the monitoring cycle has finished polling. This is normal. If the fault doesn't clear after 1 minute, check connections.

For on ship use:- battery retaining clamps must be fitted.

BATTERY CHARGING VOLTAGE CHECKS

The battery charging voltage is factory calibrated to 27.3vdc +/- 0.2v @ 20°C. This should not normally require adjustment. Where battery problems are experienced, the following information should be considered.

- If a battery is disconnected from the charger, no voltage will appear on the output leads or terminals, due to intelligent battery controls.
- Check the power supply voltage at the 28v & 0v supply output terminals. With the batteries disconnected the voltage should be 27.6vdc +/- 0.2v @ between 11°C - 40°C.
- To test the batteries, turn off the mains and see if the system will run on the batteries. Check the battery voltage, should be 26.8v for a good battery or 22v for a flat battery.
- The power supply voltage can be adjusted using the potentiometer on the power supply module (see page 7), checking at the 28v & 0v output terminals with a calibrated volt meter. Batteries should be disconnected and the Access Level 3 DIL switch should be set to 'ON' (see page 17), which will override the temperature compensation controls. Carefully adjust the voltage to 27.6vdc +/- 0.2v. When completed, switch off Access Level 3 DIL switch and re-connect the batteries.
- When the panel is re-charging a low battery, it should be possible to see the voltage across the batteries increase gradually. If this is not occurring, the batteries or the panel may be faulty.

EARTH FAULT MONITORING

The Marine panels are equipped with earth fault monitoring to the 28v supply rails. Any cable connected to earth will cause an earth fault to be indicated. The earth fault LED is located internally next to the program options switch on the main circuit board. If an earth fault exists a PSU Fault (and General Fault) will be indicated externally. The internal LED will show continuously for earth faults on the -ve polarity cables and pulse for +ve polarity cables. (Be aware sounder cables monitor in reverse). Identifying the source of the earth fault requires systematically removing cables until the fault clears. There is a 30 second delay to the earth fault signal to avoid spurious faults due to noise.

NETWORK PANELS SETUP

The system can support up to 8 networked 8-12 zone control panels, 1 x Master and up to 7 x Slaves.

Comms PCB

To run a network, a Comms PCB (TPCA05) must be fitted to each control panel.

The Comms PCB fits into the control panel on top of the main circuit board where the ribbon cable from the display board comms is normally plugged.

To fit the Comms PCB, power down the panel, un-plug the display board ribbon cable from the main circuit board and plug the Comms PCB into the socket instead.

A socket is provided on the top of the Comms PCB to re-connect the display board ribbon cable.

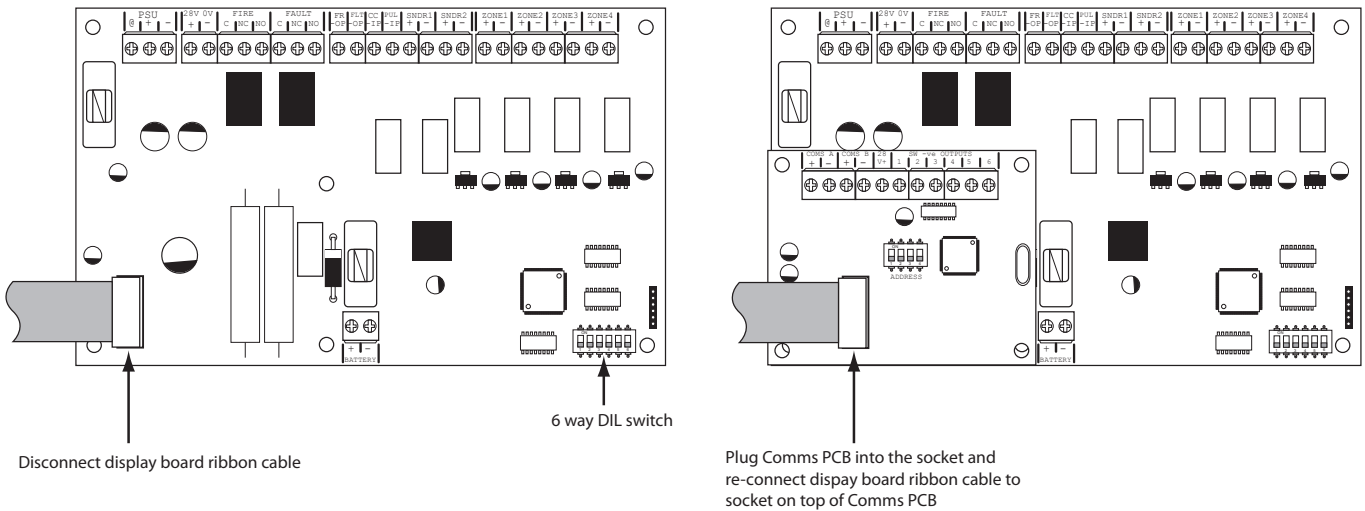

Each panel to be included in the network is defined by setting switch 5 on the 6 way DIL switch located on the main circuit board.

OFF = Stand Alone mode, ON = Network/Repeater mode.

With this switch in the ON position the panel will automatically recognise & operate the Comms PCB (TPCA05).

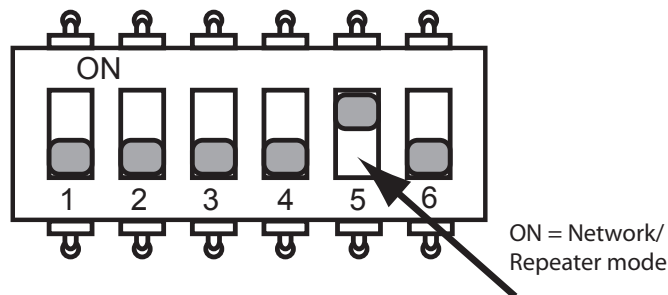

Programming

The Master panel will need to be programmed for the number of network panels on the system. See panel wide programming settings, code 2-1-2-3, option 10, (Set Number of Network Slave Panels on System).

Addressing

Each panel needs to have a unique address. The addressing is done using the 4 DIL switches on each of the Comms PCBs using binary code values, see diagram below.

The addresses should be set in sequence from 1 - 8, first slave panel = address 01, second slave panel = address 02 etc.

The Master panel is defined by being address 00 (all switches off).

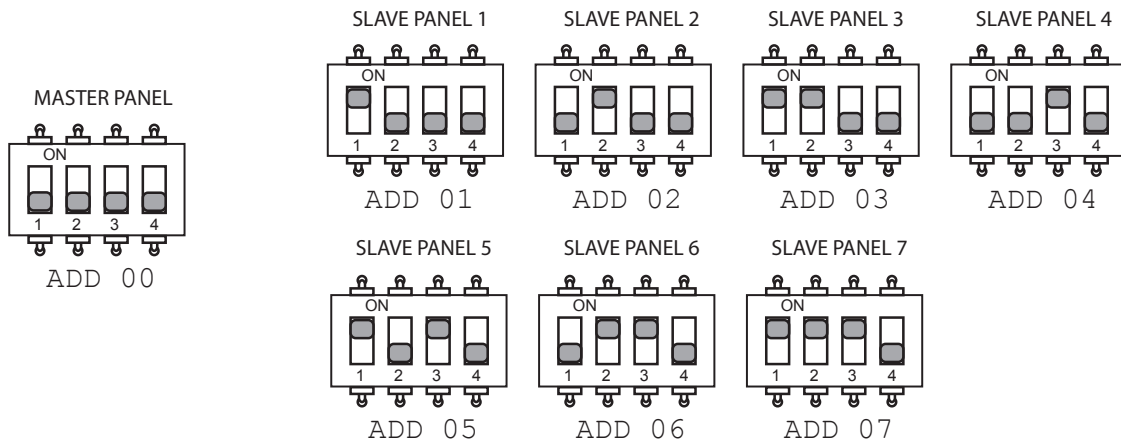

Network slave panels and/or repeater panels are designed to be wired in a fault tolerant (fail safe) loop configuration, from comms A to B and back to the Master panel again (see drawing below). This enables the network to still function if there is a break in the cables.

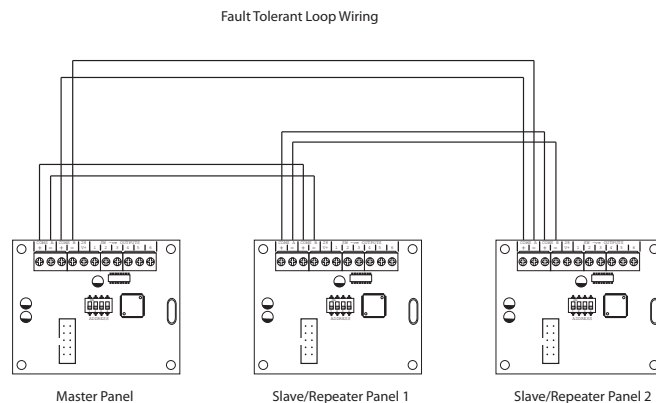

If replacing an older system where the existing cabling cannot be configured in a loop as above, it is possible to change the panel settings to legacy, radial circuit comms monitoring.

See panel wide programming settings, code 2-1-2-3, option 6, (Change Network/Repeater Comms Monitoring Type).

LEVEL 3 ENGINEERING OPTIONS

A series of programmable engineering options are available. These programming modes are initiated by entering a four digit code using buttons 1 - 4 on the keypad followed by the ENTER button.

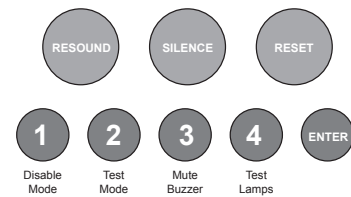

To access Level 3 options, first set switch 6 on the 7 way DIL switch located on the main PCB to the 'ON' position. Then activate the controls by turning the key switch or by entering the four digit code (see Activate Controls in the OPERATING section).

Once the controls are active, the 'Access Level' indicator will pulse to signify that Level 3 access is active.

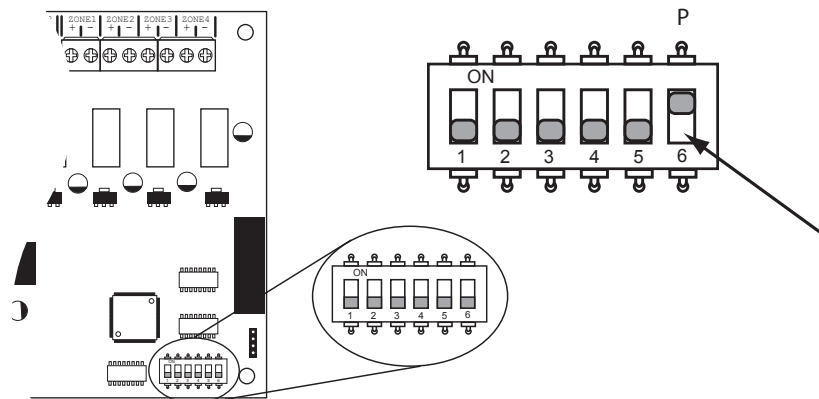

Programming throughout the panel is carried out in a sequence where the fire LEDs indicate the options to set and the fault LEDs indicate the status of these settings.

Generally button 1 is used to scroll the indications (button 3 can also be used to scroll backwards). Pressing and holding button 1 for 3 seconds at any time will exit the programming mode completely.

N.B.

The panel will automatically save settings & drop out of programming modes if left idle for more than approximately 30 seconds.

It is possible to review the settings within a programming mode without changing them. Steady Fire LEDs indicate review mode. To edit a setting first use button 1 to select the required option, pressing ENTER enables editing of the option. Flashing fire LEDs indicates edit mode and button 2 is used to change the setting.

Pressing ENTER again will exit 'edit' mode back to 'review' mode.

Some programming modes are denoted with (EN54!). Where this symbol appears EN54 compliance may be affected by this setting.

PROGRAMMING OPTIONS INDEX

Option/Setting	Description	Code(s)	Page
View History	View the last 40 events	1111	20
Set Fault Buzzer Volume	Set the fault buzzer volume to high or low	2224	21
Clear All Disablements	Remove all disablements which have been set for any zone, sounder circuit, output or delay	1121	21
Initialise Factory Settings	Restores all programming, test modes and disablements back to factory default settings	1113	21
Muster Alarm Signal / VDR card	Set zones and RESOUND button to activate a muster alarm, Muster alarm Synchronisation, Set presence of VDR card	1222	22
Panel Wide Settings	<ul style="list-style-type: none"> • Change/remove keypad access code • Set number of repeater panels on system • Set time for panel delay timer • Disable battery monitoring/UPS mode • Setup internal PCB config (add/remove zone cards) • Change network/repeater comms monitoring type • Set number of output cards • Inhibit muted tone beeps • Inhibit network alarms & faults for panel • Set number of network slave panels on system (Master Panel only) • Inhibit network slave panel fire & fault buzzer 	2123	24
Zone Function Settings	<ul style="list-style-type: none"> • Set zone to latching or non latching • Set zone to old B.S (short circuit = fire) • Set zone for use with MTL5061 I.S. barrier • Set zone to silent mode (provides visual & audible indication at the panel but no sounder operation) • Turn off priority alarm feature for zone • Turn off detector removal monitoring for zone • Set detector removal monitoring type for zone (Schottky or Zener diode detector bases) 	3121	30
Dependency Modes (False Alarm Management)	Set panel & zones to dependency mode A, B or C	2124, 2114, 2134	32
EN54 Sounder Resound Options	Set zones to not resound alarms after an initial fire condition	1114	34
Delays to Outputs	Apply delays to outputs in response to selected zones	2323	35
Input Functions	Change the default functions of the Class Change and Alert inputs	4141	36
Output Programmability & Miscellaneous	Set panel outputs to be programmable, switch on fault latching, invert fault output	4142	37
Panel Output Zonal Responses	Set how each output and sounder circuit responds for each zone (off, continuous or pulsing)	4242, 4342	38
Panel Output Functional Options	Change the default panel output & sounder circuit responses to 'Silence Alarms', 'Evacuate', 'Class Change', 'Alert' and 'Delay'	4244, 4344	40
Network Output Responses	Set local output & relay responses to network fires	4224	42
Network Sounder Responses	Set local sounder cct responses to network fires	4324	43
Comms PCB Output Functional Options	Change the default comms PCB o/p responses to 'Silence Alarms', 'Evacuate', 'Class Change', 'Alert' and 'Delay'	4343	44
System Diagnostics Mode	Tests system PCB config setup for fault diagnosis	3114	45
Repeater Programming	Repeater panel setup & programming	4443	46

1 1 1 1 View History

The control panel stores a log of the last 40 events which have occurred. This is useful for identifying intermittent faults or activations.

Enter the above code and press ENTER, the most recent event that has occurred is displayed. Use the ENTER button to progress backwards through the indications.

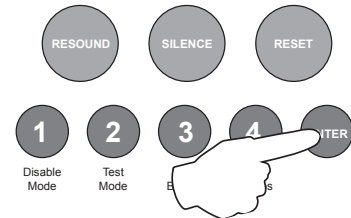

When the end of the log is reached the panel will drop out of view mode.

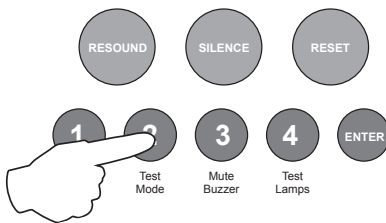

During viewing it is possible to delete the entire history by pressing and holding button 2. The panel will chirp to acknowledge deletion.

The panel will log and display the following events: zone fire activations, zone faults, power supply faults, sounder circuit faults and repeater faults.

The last two (sounder circuit faults and repeater faults) have additional information available which can be accessed by pressing and holding the ENTER button continuously.

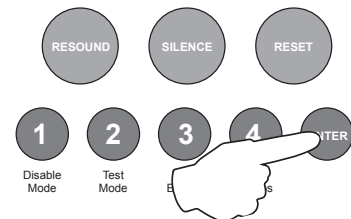

Sounder circuit faults

If a sounder circuit fault is displayed, pressing and holding the ENTER button will reveal which sounder circuit was at fault. This is indicated by the fire LEDs 1 - 6 as per the table below.

Zone 1 fire LED	Zone 2 fire LED	Zone 3 fire LED	Zone 4 fire LED	Zone 5 fire LED	Zone 6 fire LED
Main PCB SNDR 1	Main PCB SNDR 2	Zone extension card 1 (zones 5 - 8) SNDR A	Zone extension card 1 (zones 5 - 8) SNDR B	Zone extension card 2 (zones 9 - 12) SNDR A	Zone extension card 2 (zones 9 - 12) SNDR B

Repeater faults

If a repeater fault is displayed, pressing and holding the ENTER button will reveal the following further information.

The Repeater Fault LED indicates:

Slow Flash = faulty repeater, Normal Flash = repeater off line, Fast Flash = network cable error.

Red, fire LEDs 1 - 8 indicate which repeater was off line

Amber, fault LEDs 1 - 8 indicate which repeater had a PSU fault

When finished, enter the next programming code or disable the controls and return DIL switch 6 to 'OFF'.

2 2 2 4 **Set Fault Buzzer Volume**

There are two levels of volume for the internal fault buzzer, high and low.

Enter the above code and press the ENTER button to increase or decrease the fault buzzer tone from the previous level.

Setting will change when ENTER button is pressed.

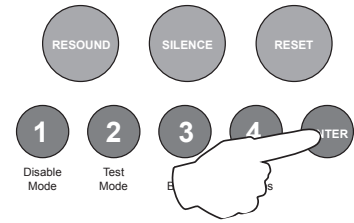

When finished, enter the next programming code or disable the controls and return DIL switch 6 to 'OFF'.

1 1 2 1 **Clear All Disablements**

Enter the above code and press the ENTER button.

Then press the ENTER button again and hold for 3 seconds.

Any disabled zone, sounder circuit, output or delay will now be enabled.

The panel will bleep to acknowledge the reset.

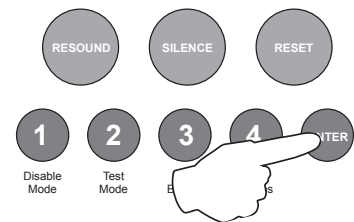

When finished, enter the next programming code or disable the controls and return DIL switch 6 to 'OFF'.

1 1 1 3 **Initialise Factory Default Settings**

Enter the above code and press the ENTER button.

Then press the ENTER button again and hold for 3 seconds.

All disablements, test modes and programming will revert back to the factory default settings.

The panel will bleep to acknowledge the reset.

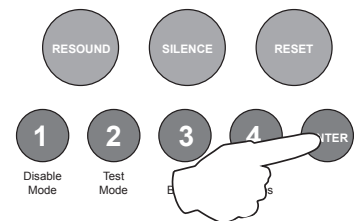

When finished, enter the next programming code or disable the controls and return DIL switch 6 to 'OFF'.

① ② ② ② **Muster Alarm Signal.**

This option is used to select zones for activation of a muster alarm signal. A muster alarm is defined as 7 short blasts of the sounders, followed by 1 long blast. This is repeated until silenced. The activated muster alarm zone will show a fire indication at the panel but no common fire LED. The panels outputs can be programmed to respond to a muster alarm using separate option codes.

A second setting is provided to enable the panels 'RESOUND' button to activate the muster alarm signal.

Note: With panel software V4.1 and above, muster alarm will have priority over any new fire alarms by default. It is possible to make fire a higher priority using option 3.

Enter the above code and press the ENTER button.

The zone 1 fire LED will be on steady. Use button 1 to toggle between steady fire LEDs 1, for setting muster alarm zones, 2, for setting RESOUND button to activate muster alarm, 3, for changing muster alarm priority or 4, for Muster Alarm Synchronisation.

LED 1	LED 2	LED 3	LED 4	LED 5
Select muster alarm zones	Set RESOUND button	Set muster alarm priority OFF	Muster synch mode (slave)	Set VDR card Presence

Set Muster Alarm Zones [LED 1]

With the zone 1 fire LED lit press the ENTER button and the LED will pulse to indicate setting zone 1 to muster alarm. Use button 1 to move the pulsing fire LED to the required zone and then use button 2 to change the setting, indicated by the amber fault LED ON or OFF. Any or all zones may be set for muster alarm.

ON = muster alarm zone, OFF = standard.

Set RESOUND Button Operation For Muster Alarm [LED 2]

With the zone 2 fire LED lit press the ENTER button. Fire LED 2 will now pulse to indicate editing mode. Use button 2 to toggle the option on or off, indicated by zone 1 amber fault LED ON or OFF.

ON = RESOUND button activates muster alarm, OFF = RESOUND button activates evacuate (default).

Set Fire As Priority Over Muster Alarm [LED 3]

With the zone 3 fire LED lit press the ENTER button. Fire LED 3 will now pulse to indicate editing mode. Use button 2 to toggle the option on or off, indicated by zone 1 amber fault LED ON or OFF.

OFF = muster alarm has priority, ON = fire has priority.

Set Muster Synch Mode [LED 4] (Slave Panels Only)

For networked panels which share sounders for Muster Alarm it is necessary, for proper synchronisation of the Muster Alarm sounders, to wire an extra synchronisation cable between the Master panel and any Slave panels in the network.

On the Master panel a suitable output e.g. FR -OP must be programmed to provide a Muster synch signal using code 4244 Option 6 (set as pulsing). Also code 4244 option 1 should be set to 'on' for the same output for ability to silence the Muster alarm.

Slave panels must have code 1222 Option 4 set to 'ON'.

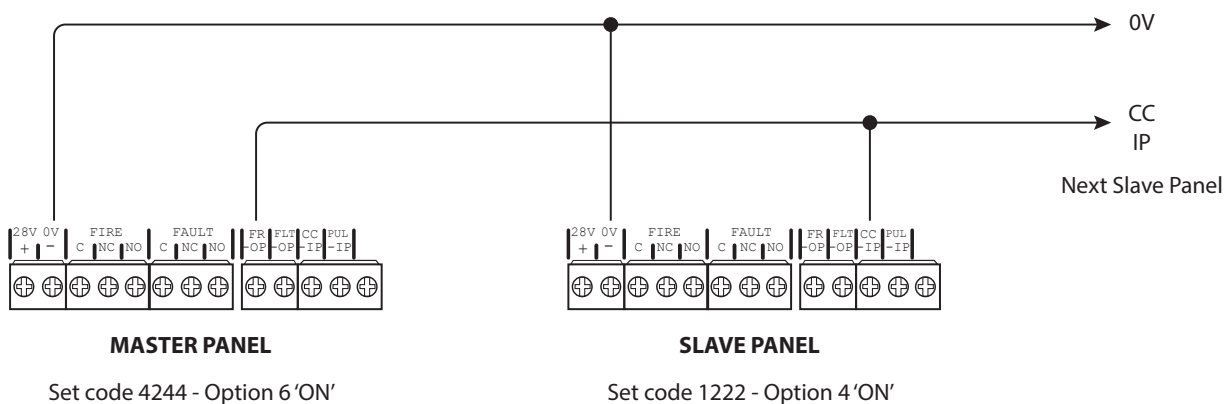

When finished, press and hold button 1 to store settings and exit programming mode. Then enter next programming code or return DIL switch 6 to 'OFF' position and disable controls.

Set presence of VDR card [LED 5]

When a VDR (Voyage data recorder) communications output card is to be used the setting must be made to allow the panel to monitor the integrity of the communications path.

With the zone 5 fire LED lit press the ENTER button. Fire LED 5 will now pulse to indicate editing mode. Use button 2 to toggle the option on or off, indicated by zone 1 amber fault LED ON or OFF.

OFF = VDR card is not present, ON = VDR card is present.

When finished, press and hold button 1 to store settings and exit programming mode. Then enter next programming code or return DIL switch 3 to 'OFF' position and disable controls.

2 1 2 3 **Panel Wide Settings**

There are 11 general, panel wide, settings available.

Enter the above code and press the ENTER button. The 11 programmable options are represented by fire zone LEDs 1 - 11.

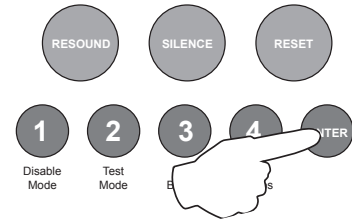

Use button 1 to move to option required as per table;

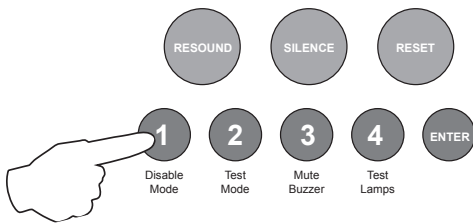

Fire LED	Programming Option
1	Change / remove keypad access code
2	Set number of repeater panels on system
3	Set time for panel delay timer (1 - 10 minutes)
4	UPS Mode / Disable battery monitoring
5	Setup internal PCB configuration (adding or removing extension zone cards)
6	Change network/repeater comms monitoring type
7	Set number of output cards
8	Inhibit muted tone beeps
9	Inhibit network alarms & faults for panel
10	Set number of network slave panels on system
11	Inhibit fire & fault buzzer on network slave panel

OPTION 1. Change / Remove Keypad Access Code

The keypad can be used to activate the panel controls instead of using the key switch. The default code is 1-2-3-4, however, this can be changed. It is also possible to disable the use of a code entry to enable controls, forcing the use of the key switch only.

With the zone 1 fire LED lit, press the ENTER button. Zone 1 fire LED will pulse to indicate 'edit mode' and the amber, fault LEDs will start to rapidly pulse in sequence to show the currently set code.

Enter the new code slowly and deliberately, one number at a time using buttons 1 - 4

Note: Enable Controls codes must always start with a 1 or 2.

When finished entering the new four digit code, press the ENTER button. The panel will then confirm the new code with rapidly pulsing LEDs in sequence and zone 1 fire LED will return to steady 'view mode'.

Changing the keypad code to 1 - 1 - 1 - 1 will disable the use of a keypad to enable controls.

Press button 1 to move to next option or hold button 1 for 3 seconds to exit programming mode 2-1-2-3. (The panel will confirm the new access code one more time before exiting the programming mode).

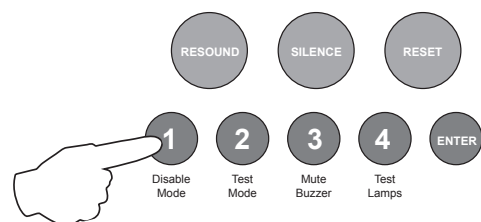

OPTION 2. Set Number of Repeater Panels on System

If repeater panels are to be used, the quantity on the system, 1- 8, must be set up for monitoring purposes. An incorrect quantity will cause a repeater fault to be shown on the panel.

With the zone 2 fire LED lit, the amber, fault LEDs will show the current quantity of repeaters set 0 - 8. (1 LED lit = 1 repeater, 2 = 2 etc..).

Press the ENTER button, zone 2 fire LED will pulse to indicate 'edit mode'.

Now use buttons 1 & 3 to increase or decrease the quantity. Button 1 increases, button 3 decreases.

When finished press the ENTER button again and the zone 2 fire LED will return to steady 'view mode'.

Press button 1 to move to next option or hold button 1 for 3 seconds to exit programming mode 2-1-2-3.

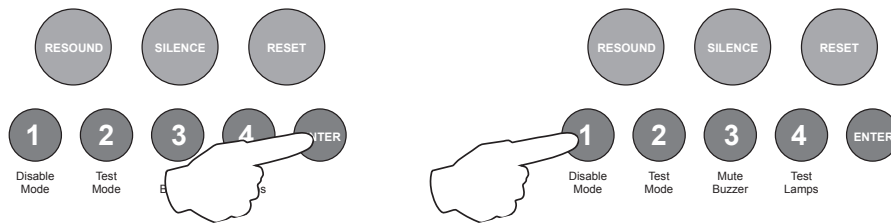

OPTION 3. Set Time For Panel Delay Timer

The panel delay time for all outputs is set here. To actually apply the delay to the desired outputs, see programming code 2-3-2-3. The default setting is 3 minutes but can be changed to between 1 - 10 minutes.

With the zone 3 fire LED lit, the amber, fault LEDs will show the current time set. The time is represented by a binary code using LEDs 1 - 4.

LED 1 = 1min, LED 2 = 2min, LED 3 = 4min, LED 4 = 8min. Therefore if LEDs 1 & 2 are lit the time is 3 minutes (1 + 2). If LEDs 2 & 4 are lit the time = 10 minutes (2 + 8).

Press the ENTER button, zone 3 fire LED will pulse to indicate 'edit mode'.

Now use buttons 1 & 3 to increase or decrease the time, each press will increase or decrease the time by 1 minute. Button 1 increases, button 3 decreases.

When finished press the ENTER button again and the zone 3 fire LED will return to steady 'view mode'.

Press button 1 to move to next option or hold button 1 for 3 seconds to exit programming mode 2-1-2-3.

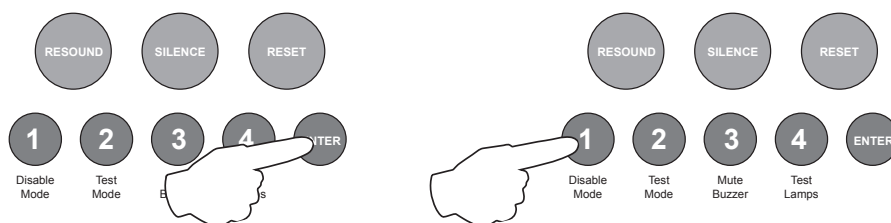

OPTION 4. UPS Mode / Disable Battery Monitoring (EN54!) & Disable Battery Hi Z Monitoring (EN54!)

The battery monitoring may be disabled for applications where this is appropriate such as non fire alarm use or where no battery backup is required. **Note: There is no remote PSU fault input available on the panel.** This is also known as 'UPS Mode' where the panel is supplied from a local 24v supply rather than mains and internal batteries.

With the zone 4 fire LED lit, the amber, fault LEDs will show the current setting.

FAULT LED 1	FAULT LED 2	SETTINGS
OFF	ON	Battery & Hi Z monitoring normal (default)
ON	ON	Battery & Hi Z monitoring both 'OFF' (UPS mode)
ON	OFF	Battery & Hi Z monitoring both 'OFF' (UPS mode)
OFF	OFF	Battery monitoring 'ON', Hi Z monitoring 'OFF'

Press the ENTER button, zone 1 fire LED will pulse to indicate 'edit mode' for std battery monitoring.

Use button 1 to toggle between pulsing fire LEDs 1 & 2 for editing std or Hi Z battery monitoring as per above.

Now use button 2 to change the setting indicated by the amber fault LED as per above.

When finished press the ENTER button again and the zone 4 fire LED will return to steady 'view mode'.

Press button 1 to move to next option or hold button 1 for 3 seconds to exit programming mode 2-1-2-3.

Note: When batteries are unmonitored the input 24v dc voltage may vary between 20v dc & 32v dc.

OPTION 5. Setup Internal PCB Configuration

The control panel monitors all internal PCBs for correct function. If adding or removing any of the additional extension zone cards, the panel must be programmed for the new configuration.

With the zone 5 fire LED lit, the amber, fault LEDs will show the current configuration setting. Each of the 2 possible additional zone cards are represented by LEDs 1 - 2 as per table below.

LED 1 (ON)	LED 2 (ON)
Extension zone card 1 (zones 5 - 8)	Extension zone card 2 (zones 9 - 12)

Press the ENTER button, zone 1 fire LED will pulse to indicate editing of 1st additional PCB as per table above. Use button 1 to move to the fire LED for the relevant PCB as per table.

Now use button 2 to change the setting indicated by the amber fault LED (LED ON = PCB included, OFF = not included).

When finished press the ENTER button again and the zone 5 fire LED will return to steady 'view mode', with the amber, fault LEDs showing the new configuration.

Press button 1 to move to next option or hold button 1 for 3 seconds to exit programming mode 2-1-2-3.

OPTION 6. Change Network/Repeater Comms Monitoring Type (EN54!)

The network & repeater panels are designed to be wired in a fault tolerant (fail safe) loop configuration, from comms A to B and back to the main panel again. This enables network & repeater panels to still work if there is a break in the cables.

If replacing an older system where the existing cabling cannot be configured in a loop as above, it is possible to change the panel back to radial circuit comms monitoring.

With the zone 6 fire LED lit, the amber, fault LED will show the current setting.

LED 1 OFF = fault tolerant monitoring (default). LED 1 ON = legacy, radial circuit monitoring.

Press the ENTER button, zone 6 fire LED will pulse to indicate 'edit mode'.

Now use button 2 to change the setting indicated by the amber fault LED ON or OFF as per above.

When finished press the ENTER button again and the zone 6 fire LED will return to steady 'view mode'.

Press button 1 to move to next option or hold button 1 for 3 seconds to exit programming mode 2-1-2-3.

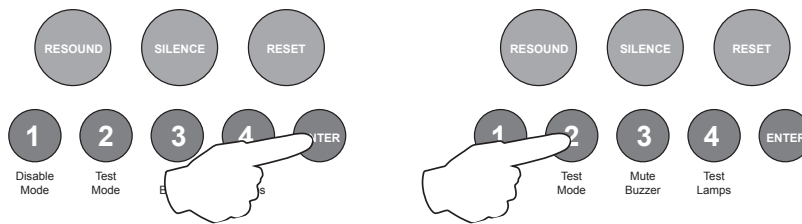

Note: When using legacy mode, comms connections should be made from 'Comms-A' to 'Comms-A'. If linking onto further units double up in Comms-A. I.e. do not use 'Comms-B' in legacy radial circuit monitoring. See diagram below.

Radial/Legacy Wiring

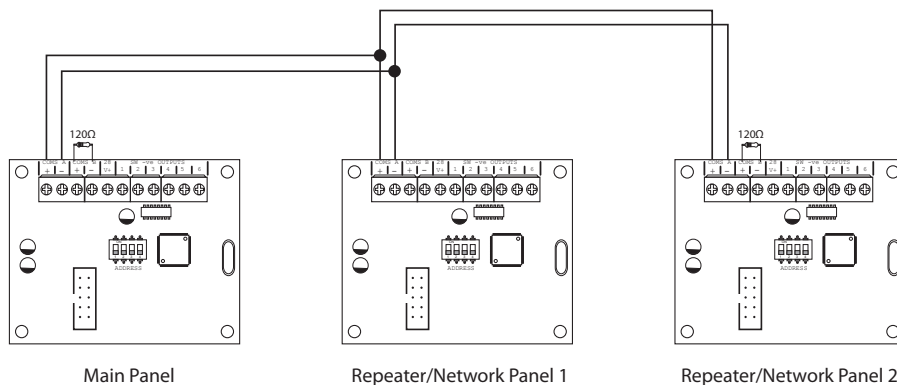

OPTION 7. Set Number of Output Cards

Up to 2 output/relay cards may be added to each control panel to provide additional common or zonal outputs. The presence of the cards must be setup to enable operation.

With the zone 7 fire LED lit, the amber, fault LEDs (zones 1 - 2) will show the current settings.

Zone 1 amber fault LED ON = Output Card 1, Zone 2 = Output Card 2.

Press the ENTER button, zone 1 fire LED will pulse to indicate adding or removing card 1.

Use buttons 1 & 3 (1=forward, 3=backward) to move the pulsing fire LED to the required zone (Cards 1 - 2 indicated by zones 1 & 2 respectively).

Then use button 2 to add or remove the card, indicated by the amber fault LED ON (added) or OFF (removed).

When finished press the ENTER button again and the zone 7 fire LED will return to steady 'view mode'.

Press button 1 to move to next option or hold button 1 for 3 seconds to exit programming mode 2-1-2-3.

OPTION 8. Inhibit Muted Tone Beeps

Option to inhibit the intermittent beep that still occurs when a fault or fire tone has been muted using the Mute Buzzer button.

With the zone 8 fire LED lit, Press the ENTER button. The zone 1 fire LED will pulse 'edit mode'.

Press button 1 to light the zone 1 fault LED. Beeps are now silenced.

When finished press the ENTER button again and the zone 8 fire LED will return to steady 'view mode'.

Press button 1 to move to next option or hold button 1 for 3 seconds to exit programming mode 2-1-2-3.

OPTION 9. Inhibit Network Alarms & Faults For Panel

This option prevents any other network panel's alarms or faults from displaying or having any effect on the panel.

The default setting is ON (panel displays all network alarms & faults and the outputs respond accordingly).

If set to OFF, alarms & faults from other network panels will be ignored. Fires & faults from this panel will still affect other network panels accordingly.

With the zone 9 fire LED lit, Press the ENTER button. The zone 9 fire LED will pulse 'edit mode'.

The zone 9 fault LED will be lit (indicates network alarms & faults active).

Press button 1 to change the fault LED to OFF (network alarms & faults inhibited).

When finished press the ENTER button again and the zone 9 fire LED will return to steady 'view mode'.

Press button 1 to move to next option or hold button 1 for 3 seconds to exit programming mode 2-1-2-3.

OPTION 10. Set Number of Network Slave Panels on System (Master Panel Only)

If using network slave control panels, the Master panel will need to be programmed with which slave panel addresses are included in the system, for monitoring purposes. An incorrect quantity will cause a system fault to be displayed on the panels.

With the zone 10 fire LED lit the amber fault LEDs will display the current slave panel addresses set (0 - 7), amber fault LED 1 = slave address 01 etc.

Press the ENTER button. The zone 1 fire LED will pulse to indicate adding or removing slave address 01.

Use buttons 1 & 3 (1=forward, 3=backward) to move the pulsing fire LED to the required zone (addresses 1 - 7 indicated by zones 1 - 7 respectively).

Then use button 2 to add or remove the slave address, indicated by the amber fault LED ON (added) or OFF (removed).

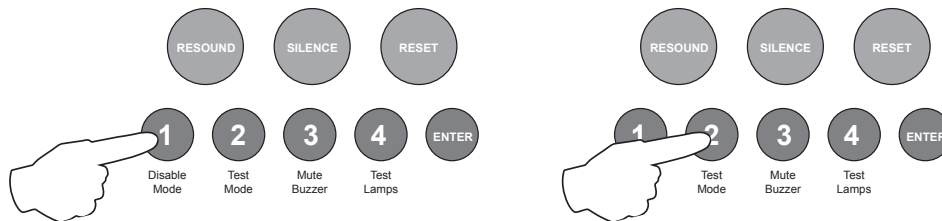

Tip - You can use button 4 as a shortcut to add or remove all 7 addresses in one go.

When finished press the ENTER button again and the zone 10 fire LED will return to steady 'view mode'.

Press button 1 to move to next option or hold button 1 for 3 seconds to exit programming mode 2-1-2-3.

OPTION 11. Inhibit Fire & Fault Buzzer on Network Slave Panel

It is possible to inhibit the fire and/or fault buzzers of the network slave panels. This is useful if the panels are to be mounted together for a larger system. This option must be set on each individual slave panel.

With the zone 11 fire LED lit press the ENTER button. The zone 1 fire LED will pulse to indicate editing the panels fault buzzer.

Editing of the fault buzzer is indicated by the zone 1 LEDs and editing the panels fire buzzer is indicated by the zone 2 LEDs.

Use buttons 1 & 3 (1=forward, 3=backward) to move the pulsing fire LED to the required zone as per above.

Then use button 2 to Disable or Activate the buzzer indicated by the amber fault LED.

Fault LED OFF = Buzzer Active ~ Fault LED ON = Buzzer Disabled

When finished press the ENTER button again and the zone 11 fire LED will return to steady 'view mode'.

Press button 1 to move to next option or hold button 1 for 3 seconds to exit programming mode 2-1-2-3.

When finished all panel wide programming, enter the next programming code or disable the controls and return DIL switch 6 to 'OFF'.

3 1 2 1 Zone Function Settings

There are 8 functional settings available for each zone. These are as follows:

Fire latching

Normally a zone latches a fire input signal. This setting allows the panel to clear automatically when a fire signal is removed. This is useful for interfacing purposes.

Short circuit as alarm (EN54!)

For Older non EN54 or BS5839 compliant systems. This allows a short circuit to generate a fire condition rather than a fault.

Intrinsically safe operation

This option changes the zone alarm and short circuit thresholds to allow for an MTL 5561 type intrinsically safe barrier to be used in the circuit.

Silent mode

This setting provides a visual & audible alarm at the panel with no local sounder circuit operation.

Priority alarm (EN54!)

Normally a 220R call point will override delays or dependency alarms. This option allows turning off the priority alarm feature.

Detector removal (EN54!)

The detector removal monitoring can be turned off. For use with older non compliant detectors.

Detector removal type

Schottky diode or Zener diode type detector bases for conventional zones (Does not apply to Twin wire circuits). The default operation is for schottky diode bases but can be changed for use with older Hochiki liveline bases or similar.

Enter the code **3 1 2 1** and press the ENTER button.

The zone 1 fire LED will light. This indicates setting zone function attributes for zone 1. The amber, fault LEDs will show the current settings for that zone.

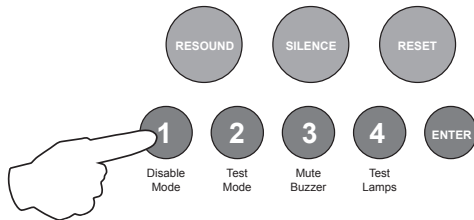

Use button 1 to move to the zone that requires editing.

With the required zone for editing LED lit, press the ENTER button to enter 'editing mode'.

The fire zone 1 LED will now pulse to indicate the editing of attribute 1 (fire latching) for the selected zone.

Use button 1 to scroll to the attribute that requires editing, indicated by a pulsing fire LED 1 - 9 as per table below.

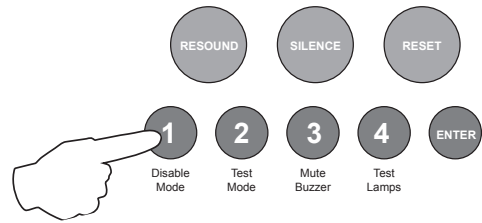

The setting of the attribute is indicated by the amber, fault LED, ON or OFF.

Fire LED (pulsing)	LED 1	LED 2	LED 3	LED 4	LED 5	LED 6	LED 7	LED 8	LED 9
Attribute	Fire latching	Short circuit as fire	I.S operation	Silent mode	Priority alarm	Detector removal monitoring	Zener diode detector bases	Gate valve & fire pump (see over page)	Delayed (info only)
Amber fault LED (default setting)	ON	OFF	OFF	OFF	ON	ON	OFF	OFF	OFF

Use button 2 to switch the attribute ON or OFF, indicated by the amber, fault LED, then use button 1 to move to the next attribute if required.

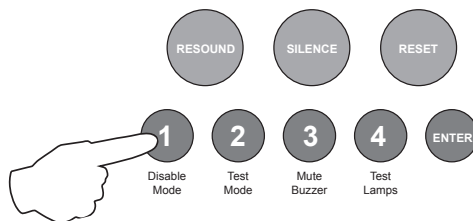
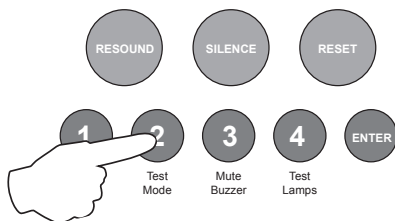

Press the ENTER button to return back to the zone selection, indicated by a steady zone fire LED

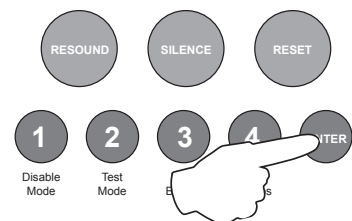

When finished all the zone function programming, enter the next programming code or disable the controls and return DIL switch 6 to 'OFF'.

DEPENDENCY MODES (FALSE ALARM MANAGEMENT)

Dependency modes are features described in EN54-2 for the processing of confirmation alarms. It is a requirement by some monitoring stations and local fire authorities in order to reduce the possibility of false alarms.

The panel has 3 dependency mode options, A, B & C. Only one type can be applied to the panel but any or all zones can be independently set for dependency mode.

Dependency mode, if assigned to a zone, is set to type A by default.

Dependency 'A' will apply the following sequence:

1. The first detector alarm is inhibited.
2. The panel resets and re-checks the inhibited zone within 15-30 seconds.
3. If an alarm is detected then the panel activates a full fire condition.
4. If no alarm is detected, the panel stays in an alert condition for 30 minutes. Any new alarm from the same zone within this time activates a full fire condition.
5. After 30 minutes or if RESET, the panel reverts to step 1.

Note: 220Ω 'Evacuate' call points should be used on such zones to provide an instant un-delayed alarm. A 470Ω call point will be included in the dependency delay sequence.

Dependency 'B' will apply the following sequence:

1. The first detector alarm will indicate at the control panel but not activate the sounders.
2. The panel resets and re-checks the inhibited zone within 1 - 4 minutes (programmable, see code 2-1-3-4) ¹.
3. If an alarm is detected then the panel activates a full fire condition.
4. If no alarm is detected, the panel stays in an alert condition for 5 - 30 minutes (programmable, see code 2-1-3-4) ². Any new alarm from the same or a different zone within this time activates a full fire condition.
5. After the time set above or if RESET, the panel reverts to step 1.

Note: 220Ω 'Evacuate' call points should be used on such zones to provide an instant un-delayed alarm. A 470Ω call point will be included in the dependency delay sequence.

Dependency 'C' will apply the following sequence:

1. The first detector or 470Ω call point alarm will indicate at the control panel but not activate the sounders.
2. The panel will not activate a full fire condition unless a second detector or 470Ω call point is activated in the same or any other zone.

Note: A 220Ω 'Evacuate' call point can be used on such zones to provide an instant un-delayed alarm.

② ① ② ④ **Dependency Mode Selection**

To change the dependency mode type for the panel, enter the above code and press ENTER (panel is set to type A by default).

The amber, fault LED 1 will pulse and the current setting will be indicated by a steady amber, fault LED as per table below.

LED 1	LED 2	LED 3	LED 4
No Dependency Mode	Type A	Type B	Type C

Use button 1 to move the pulsing amber LED to the required type as per above and press ENTER to select it. The LED will change to a rapid pulse to indicate that it is now the current setting.

Type 'C' Configuration Option

In type 'C' Dependency Mode it is possible to select which outputs are delayed by the dependency.

Pressing button 4 will alternate between 'Sounders' and 'Aux' and all possible combinations using the Sounder and Aux active LED to indicate the delay setting, i.e. 'ON' = DELAYED.

Note:- Sounder = 4 conventional sounder circuits
Aux = Fire relay & switch negative outputs

Press and hold button 1 for 3 seconds to save the setting and exit the programming mode.

② ① ① ④ **Select Zones For Dependency Mode**

To select which zones should be included in the dependency mode, enter the above code and press ENTER.

The amber, fault LED 1 will pulse and any zones that are currently set to dependency mode will be indicated by a steady amber, fault LED.

Use button 1 to move the pulsing amber LED to the required zone(s) for setting and press ENTER to select. The LED will change to a rapid pulse to indicate that the zone is now set to dependency mode. Pressing ENTER again will de-select the zone and the LED will change back to a slow pulse.

Press and hold button 1 for 3 seconds to save the settings and exit the programming mode.

② ① ③ ④ **Set Timings For Dependency Mode B**

There are two programmable timings for dependency mode B, the confirmation time ¹, and the auto reset time ².

Enter the above code and press ENTER. The fire LED 1 will light indicating changing the timing for the confirmation time, 1 - 4 minutes. Use button 1 to move to fire LED 2, for changing the timing for the auto reset time (5 - 30 minutes).

With the required fire LED lit, the amber, fault LEDs will indicate the current timings set. Press the ENTER button to enter 'edit mode' and the fire LED will change to pulsing.

Now use buttons 1 & 3 to increase or decrease the time. Button 1 increases, button 3 decreases. When finished press ENTER again to return to 'view mode'

The confirmation time ¹ is indicated by the amber, fault LEDs 1 - 4 (1 - 4 minutes).

The auto reset time ² is indicated by the amber, fault LEDs 1 - 5 using binary code values. See table below. Each push will increase or decrease the time by 1 minute.

AMBER LED 1	AMBER LED 2	AMBER LED 3	AMBER LED 4	AMBER LED 5
1 Minute	2 Minutes	4 Minutes	8 Minutes	16 Minutes

① ① ① ④ EN54 Sounder Resound Options

By default, after an initial fire condition and the (blue) Silence Alarms button has been activated, any new fire condition in a different zone will cause the alarms to resound.

It is possible to change this on a zonal basis so that any new alarm in a different zone will not resound the alarms.

Enter the above code and press the ENTER button. The Sounder Status LED will pulse slowly. Zone Fault LEDs will show their current status (see below) with Zone 1 pulsing to indicate it is under selection.

Use Button 1 to move to the zone for programming (indicated by a pulsing LED) and press the ENTER button to change the status.

Pressing the ENTER button again will toggle the status, indicated by a rapid or slow pulsing LED (see below). Then use Button 1 to move to the next zone. If the zone has been set to not resound alarms, the LED will be off. If kept as default, new fire condition will resound alarms, then the LED will be on steady.

Rapid Pulse = Zone is under selection and is set to have alarms resound (default).

Slow Pulse = Zone is under selection and has been set to not resound alarms on new fire condition.

LED Off = Zone has been set to not resound alarms on new fire condition.

LED On = Zone is set to have alarms resound (default).

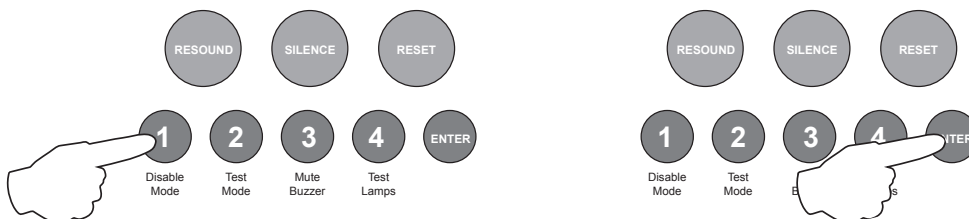

When finished, press and hold Button 1 for 3 seconds to save setting and exit programming mode

Enter the next programming code or disable the controls and return DIL switch 6 to 'OFF'.

② ③ ② ③ **Apply Delay to Outputs For Selected Zones**

The activation of sounder circuits and aux outputs can be delayed in response to selected zones. The actual delay time is set up in the panel wide programming options, 2-1-2-3.

The setting of delays here applies to all sounder circuits, all aux outputs or all sounder circuits and all aux outputs.

Individual outputs can be programmed to be active during a delay in the output functional options.

To apply the delays for selected zones, enter the above code and press ENTER.

The zone 1 fire LED will illuminate. This indicates that delays are being applied for zone 1. Use button 1 to move the LED to the required zone for programming.

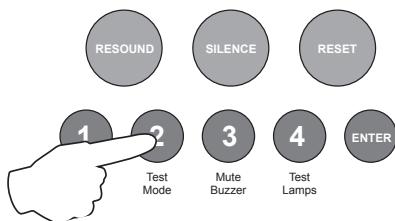
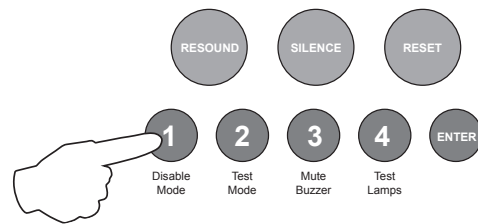

With the required zone LED lit, press the ENTER button to enter 'edit mode'. The fire LED will now pulse. Now use button 2 to turn on delays, this is indicated by the zone, amber, fault LED, ON.

Pressing button 2 again will toggle the delays ON & OFF, indicated by the zone, amber, fault LED.

With the amber LED, ON, use button 3 to select which outputs are to be delayed. The choice toggles between, all sounder circuits, all aux outputs or all sounder circuits and all aux outputs.

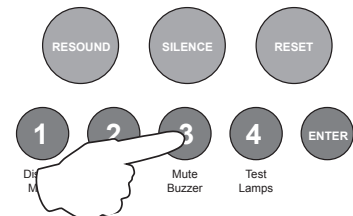

The selection is indicated by the Sounder Status LED and the Aux Output Status LED.

When finished programming for the zone, press the ENTER button again to return to the zone selection, indicated by a steady fire LED.

If a delay has been applied to a zone, the Delay Status LED will be lit permanently, to indicate that a programmed delay exists. When a fire condition is active in a zone with a delay, the Delay Status LED will pulse. When the delay time has expired the LED will extinguish.

To override a delay a 220Ω 'Evacuate' call point can be used or a different zone can be activated that has no delays programmed.

When the Delay Status LED is active, the delay can be temporarily disabled using the panels disablements feature. If the delay has been disabled the Delay Status LED will be extinguished.

When finished, press and hold Button 1 for 3 seconds to save setting and exit programming mode

Enter the next programming code or disable the controls and return DIL switch 6 to 'OFF'.

4 1 4 1 Input Function Settings

The panel has two inputs, located on the main circuit board, Class Change (CC) and Alert (PUL). Switching a negative voltage into these inputs will cause the alarm sounders to operate. The Class Change input (CC) will cause the alarms to sound continuously and the Alert input (PUL) will cause the alarms to pulse.

Either or both of these inputs can be programmed to have a different function.

The available functions are:

- Class Change (continuous sounder operation).
- Alert (pulsing sounder operation).
- Evacuate (a latching input which activates all the alarms and shows a general fire indication on the panel).
- Silence (for remote silence alarms control).
- Reset (for remote reset control).
- Fire Zone 12 (a non latching input which indicates zone 12 fire LED).
- Fault Zone 12 (a non latching input which indicates zone 12 fault LED).
- Input activates Muster Alarm signal.

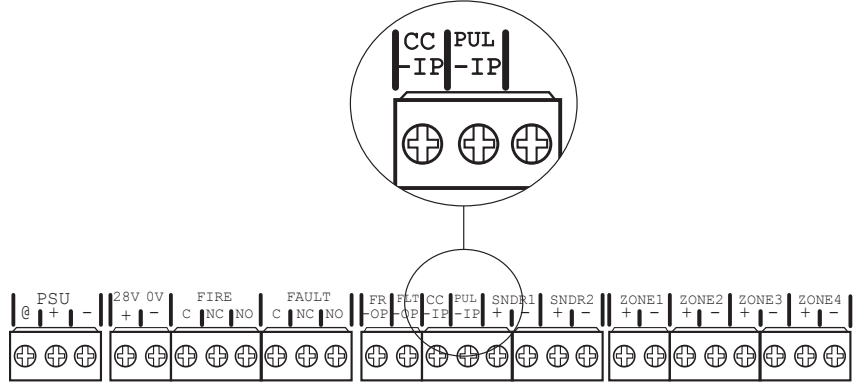

To change the default function of the inputs, enter the above code and press ENTER. The zone 1 fire LED will illuminate. This indicates setting the function of the CC input. Use button 1 to move to zone 2 fire LED for setting the function of the PUL input and then back to zone 1 again.

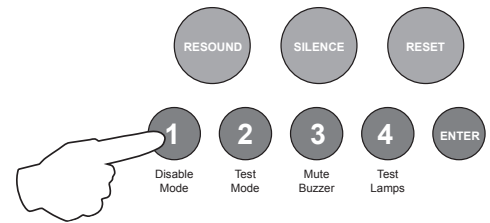

The current setting for the input will be indicated by the amber, fault LEDs as per table below.

With the required fire LED lit, as per above, press the ENTER button to enter 'editing mode'. The fire zone 1 LED will now pulse to indicate function 1 (Class Change).

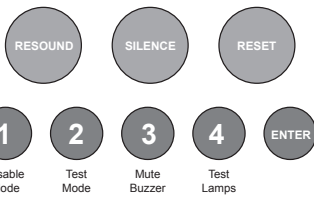

Now use button 1 to move the pulsing fire LED to the required setting as per the table below, then use button 2 to select the function. The amber, fault LED will move to indicate the new current setting.

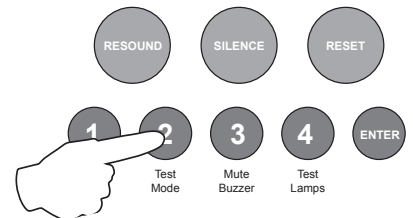

LED 1	LED 2	LED 3	LED 4	LED 5	LED 6	LED 7	LED 8
Class Change	Alert	Evacuate	Remote Silence Alarms	Remote Reset	Fire Zone 12	Fault Zone 12	Muster Alarm

Press the ENTER button again to return to input selection.

When finished, press and hold Button 1 for 3 seconds to save setting and exit programming mode. Enter the next programming code or disable the controls and return DIL switch 6 to 'OFF'.

④ ① ④ ② **Output Programmability & Miscellaneous**

All of the relays & outputs on the control panel's main circuit board (TPC-A01) have default functions, i.e. operate on fire or fault. The function for each of these outputs, however, can be changed. The outputs can also be programmed to have different responses for selected zones.

Before any programming can be applied to the main circuit board outputs, they must first be made programmable using this mode.

Mode 4-1-4-2 also has 2 other miscellaneous functions, these are:

Set Fault Latching - This sets the latching of all faults on the panel. A useful tool for capturing any random or intermittent faults.

Invert Fault Output - The switched -ve fault output on the main circuit board usually appears when a fault is present. This can be inverted so that the output is constant and disappears when a fault occurs, for fail safe operation.

To set either of the two miscellaneous options above or to make outputs programmable, enter the above code and press ENTER.

The fire zone 1 LED will now pulse to indicate the setting of attribute 1 (fault latching).

Use button 1 to scroll to the attribute that requires setting, indicated by a pulsing fire LED 1 - 6 as per table below.

The setting of the attribute is indicated by the amber, fault LED, ON or OFF.

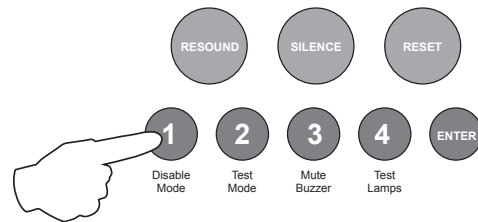

Fire LED (pulsing)	LED 1	LED 2	LED 3	LED 4	LED 5	LED 6
Attribute	Fault latching	Invert Fault Output	Fault Relay Programmable	Fault Output Programmable	Fire Relay Programmable	Fire Output Programmable

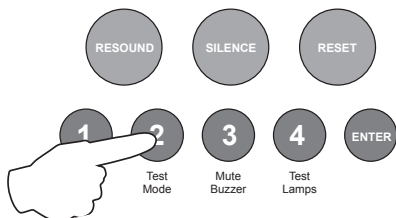

With the required fire LED pulsing, use button 2 to switch the attribute ON or OFF (amber, fault LED, ON or OFF).

When finished, press and hold Button 1 for 3 seconds to save setting and exit programming mode

Enter the next programming code or disable the controls and return DIL switch 6 to 'OFF'.

4 2 4 2 Relay & Output Responses to Selected Zones

Each of the relays and switched -ve outputs on the main circuit board and high spec zone extension cards can be independently programmed to respond in one of three different ways for each zone, ON, OFF or PULSING.

Note:- (Before any programming can be applied to the outputs on the main circuit board, they must first be made programmable. See programming option 4-1-4-2).

Enter the code, 4-2-4-2 and press the ENTER button.

The zone 1 fire LED will light. This indicates setting how each of the outputs are to respond for zone 1.

The amber, fault LEDs will show the current output settings for that zone. See table below

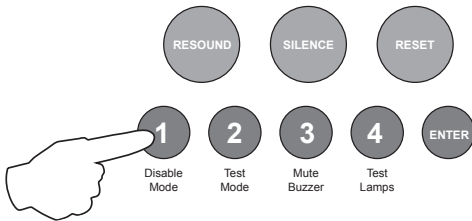
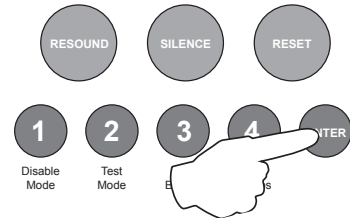

Use button 1 to move to the zone that requires editing.

With the required zone for editing LED lit, press the ENTER button to enter 'editing mode'.

The fire zone 1 LED will now pulse to indicate setting the response of the first output (fire relay on main circuit board) for the selected zone.

Use button 1 to scroll to the output that requires editing, indicated by a pulsing fire LED 1 - 10 as per table below.

The setting of the output is indicated by the amber, fault LED, ON, OFF or PULSING.

LED 1	LED 2	LED 3	LED 4	LED 5	LED 6	LED 7	LED 8	LED 9	LED 10
Fire Relay (Main PCB)	Fault Relay (Main PCB)	Fire O/P (Main PCB)	Fault O/P (Main PCB)	OPA Zone ext card 1 (Zones 5 - 8)	OPB Zone ext card 1 (Zones 5 - 8)	Aux Relay Zone ext card 1 (Zones 5 - 8)	OPA Zone ext card 2 (Zones 9 - 12)	OPB Zone ext card 2 (Zones 9 - 12)	Aux Relay Zone ext card 2 (Zones 9 - 12)

Use button 2 to change the response of the output for the selected zone, ON, OFF or PULSING, indicated by the amber, fault LED, then use button 1 to move to the next output if required.

Tip - You can use button 4 to change the response of all outputs simultaneously to ON, OFF or PULSING (for faster programming).

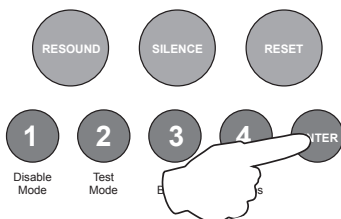
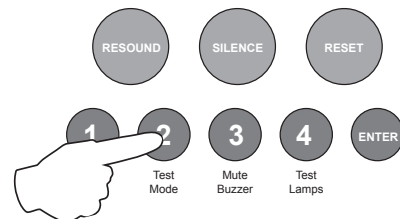

Press the ENTER button to return back to the zone selection, indicated by a steady zone fire LED

When finished, press and hold Button 1 for 3 seconds to save setting and exit programming mode

Enter the next programming code or disable the controls and return DIL switch 6 to 'OFF'.

4 3 4 2 **Conventional Sounder Circuit Responses to Selected Zones**

Each of the conventional sounder circuits on the main circuit board and high spec zone extension cards can be independently programmed to respond in one of three different ways for each zone, ON, OFF or PULSING.

Enter the above code and press the ENTER button.

The zone 1 fire LED will light. This indicates setting how each of the sounder circuits are to respond for zone 1.

The amber, fault LEDs will show the current sounder circuit settings for that zone. See table below

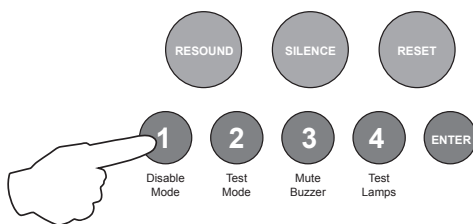
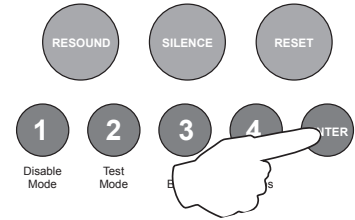

Use button 1 to move to the zone that requires editing.

With the required zone for editing LED lit, press the ENTER button to enter 'editing mode'.

The fire zone 1 LED will now pulse to indicate setting the response of the first sounder circuit (SNDR1 on main circuit board) for the selected zone.

Use button 1 to scroll to the sounder circuit that requires editing, indicated by a pulsing fire LED 1 - 6 as per table below.

The setting of the sounder circuit is indicated by the amber, fault LED, ON, OFF or PULSING.

LED 1	LED 2	LED 3	LED 4	LED 5	LED 6
SNDR1 (Main PCB)	SNDR2 (Main PCB)	SNDR A. Zone ext card 1 (Zones 5 - 8)	SNDR B. Zone ext card 1 (Zones 5 - 8)	SNDR A. Zone ext card 2 (Zones 9 - 12)	SNDR B. Zone ext card 2 (Zones 9 - 12)

Use button 2 to change the response of the sounder circuit for the selected zone, ON, OFF or PULSING, indicated by the amber, fault LED, then use button 1 to move to the next output if required.

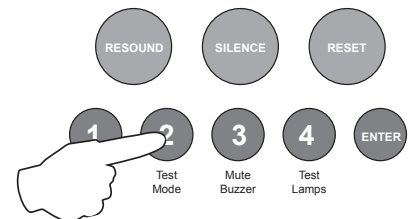

Tip - You can use button 4 to change the response of all sounder circuits simultaneously to ON, OFF or PULSING (for faster programming).

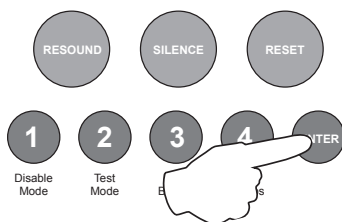

Press the ENTER button to return back to the zone selection, indicated by a steady zone fire LED

When finished, press and hold Button 1 for 3 seconds to save setting and exit programming mode

Enter the next programming code or disable the controls and return DIL switch 6 to 'OFF'.

4 2 4 4 Relay & Output Functional Options

Each of the relays and switched -ve outputs on the main circuit board and high spec zone extension cards can be independently programmed with a custom response to; Silence Alarms (including, Silence button or input programmed for remote Silence Alarms), Evacuate (including, Resound button, input programmed for Evacuate or 220Ω 'Evacuate' call point), Class Change Input, Alert Input, during Zone Delays or follows Muster Alarm sequence (for synchronisation of slave panels). **Note:-** To follow Muster alarm sequence the output must be set to the Pulsing option for LED 6.

Note:- (Before any programming can be applied to the outputs on the main circuit board, they must first be made programmable. See programming option 4-1-4-2).

Enter the code, 4-2-4-4 and press the ENTER button.

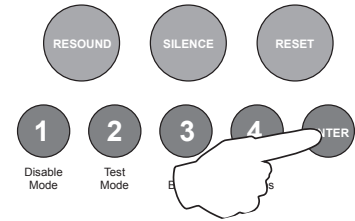

The zone 1 fire LED will light. This indicates the output to be programmed as per the table below.

LED 1	LED 2	LED 3	LED 4	LED 5	LED 6	LED 7	LED 8	LED 9	LED 10
Fire Relay (Main PCB)	Fault Relay (Main PCB)	Fire O/P (Main PCB)	Fault O/P (Main PCB)	OPA Zone ext card 1 (Zones 5 - 8)	OPB Zone ext card 1 (Zones 5 - 8)	Aux Relay Zone ext card 1 (Zones 5 - 8)	OPA Zone ext card 2 (Zones 9 - 12)	OPB Zone ext card 2 (Zones 9 - 12)	Aux Relay Zone ext card 2 (Zones 9 - 12)

Use button 1 to move the fire LED to the output that requires editing.

With the required output for editing LED lit, press the ENTER button to enter 'editing mode'.

The fire zone 1 LED will now pulse to indicate setting the selected output's response to the first function (Resets on Silence Alarms).

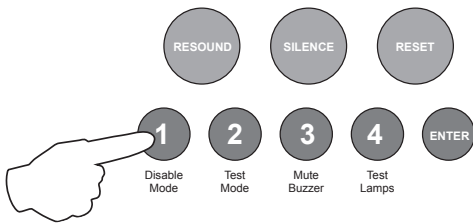

Use button 1 to scroll to the function that requires editing for that output, indicated by a pulsing fire LED 1 - 5 as per table below.

Fire LED (pulsing)	LED 1	LED 2	LED 3	LED 4	LED 5	LED 6
Function	Resets on Silence Alarms	Activates on Evacuate	Activates on Class Change	Activates on Alert	Activates During Delay	Follows Muster Alarm
Amber fault LED (default setting)	OFF	ON *	OFF	OFF	OFF	OFF

* Fault relay & output default to 'OFF'

Use button 2 to change the response for the output as per table above, indicated by the amber, fault LED, ON, Pulsing or OFF. Then use button 1 to move to the next function if required.

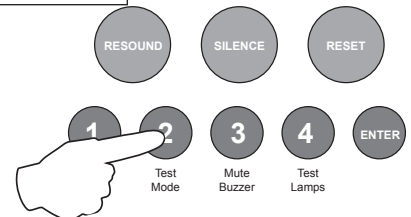

Press the ENTER button to return back to the output selection, indicated by a steady zone fire LED

When finished, press and hold Button 1 for 3 seconds to save setting and exit programming mode.

④ ③ ④ ④ **Conventional Sounder Circuit Functional Options**

To programme each of the conventional sounder circuits on the main circuit board and high spec zone extension cards with same custom responses as above, the process is exactly the same but using the code 4-3-4-4.

I.e. Use button 1 to select the sounder circuit first (indicated by a steady fire zone LED) as per table below.

LED 1	LED 2	LED 3	LED 4	LED 5	LED 6
SNDR1 (Main PCB)	SNDR2 (Main PCB)	SNDR A. Zone ext card 1 (Zones 5 - 8)	SNDR B. Zone ext card 1 (Zones 5 - 8)	SNDR A. Zone ext card 2 (Zones 9 - 12)	SNDR B. Zone ext card 2 (Zones 9 - 12)

Press ENTER and then use button 1 to select the function that requires editing for that sounder circuit (indicated by a pulsing fire zone LED) as per the sounder CCT function table in the Twin Wire settings above.

Use button 2 to edit the response indicated by the amber, fault LED, ON or OFF.

Press the ENTER button to return back to the sounder circuit selection, indicated by a steady zone fire LED.

When finished, press and hold Button 1 for 3 seconds to save setting and exit programming mode.

4 2 2 4 Output & Relay Network Responses

The Fire relays and switched negative outputs in the panel will, by default, activate continuously for any fire condition from the entire network.

The Fault relay and other switched negative outputs will also activate continuously, by default, if they have been made programmable using programming option 4-1-4-2.

This option enables the default to be changed for each of the local relays and outputs. The response can be either; CONTINUOUS, PULSING or NONE when a fire condition is received from any other panel in the network.

Enter the above code and press the ENTER button.

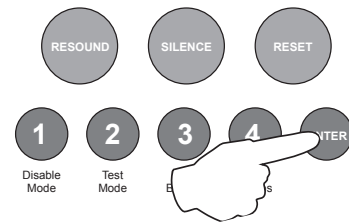

The zone 1 fire LED will pulse indicating setting the response for the Fire relay on the main PCB.

The relays and outputs are represented by zone LEDs 1 - 10 as per table below.

A pulsing red fire LED indicates which relay or output is selected and the setting is represented by the amber fault LED. See tables below.

Use button 1 to move the pulsing fire LED to the required relay or output, then use button 2 to change the response, indicated by the amber fault LED. Each press of button 2 will toggle through the 3 available responses.

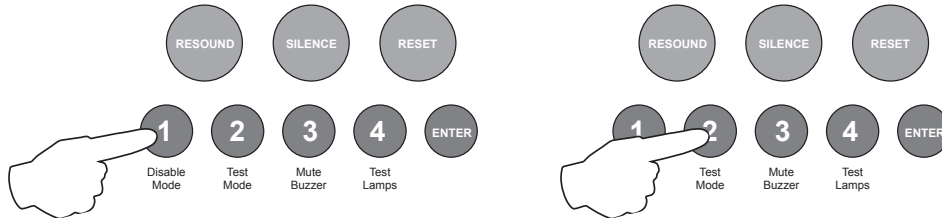

LED 1	LED 2	LED 3	LED 4	LED 5	LED 6	LED 7	LED 8	LED 9	LED 10
Fire Relay (Main PCB)	Fault Relay (Main PCB)	Fire O/P (Main PCB)	Fault O/P (Main PCB)	OPA Zone ext card 1 (Zones 5 - 8)	OPB Zone ext card 1 (Zones 5 - 8)	Aux Relay Zone ext card 1 (Zones 5 - 8)	OPA Zone ext card 2 (Zones 9 - 12)	OPB Zone ext card 2 (Zones 9 - 12)	Aux Relay Zone ext card 2 (Zones 9 - 12)

Amber LED ON	Relay/output activates CONTINUOUSLY for other network panel fires
Amber LED PULSING	Relay/output PULSES for other network panel fires
Amber LED OFF	Relay/output NO RESPONSE for other network panel fires

When finished, press and hold Button 1 for 3 seconds to save setting and exit programming mode.

Note:- The relay and output responses to a fire condition from their own panel are set using programming option 4-2-4-2.

If a local response has been programmed, consideration should also be given to the network response which may affect it.

④ ③ ② ④ **Sounder Circuit Network Responses**

The six possible sounder circuits in the panel will, by default, activate continuously for any fire condition from the entire network.

This option enables the default to be changed for each of the local circuits. The response can be either; CONTINUOUS, PULSING or NONE when a fire condition is received from any other panel in the network.

Enter the above code and press the ENTER button.

The zone 1 fire LED will pulse indicating setting the response for sounder circuit 1.

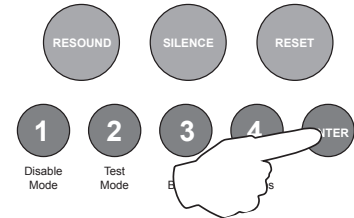

Sounder circuits 1 - 6 are represented by zone LEDs 1 - 6 respectively.

A pulsing red fire LED indicates which circuit is selected and the setting is represented by the amber fault LED as per table below.

Use button 1 to move the pulsing fire LED to the required circuit, then use button 2 to change the response of the circuit, indicated by the amber fault LED. Each press of button 2 will toggle through the 3 available responses.

LED 1	LED 2	LED 3	LED 4	LED 5	LED 6
SNDR1 (Main PCB)	SNDR2 (Main PCB)	SNDR A. Zone ext card 1 (Zones 5 - 8)	SNDR B. Zone ext card 1 (Zones 5 - 8)	SNDR A. Zone ext card 2 (Zones 9 - 12)	SNDR B. Zone ext card 2 (Zones 9 - 12)

Amber LED ON	Sounder circuit activates CONTINUOUSLY for other network panel fires
Amber LED PULSING	Sounder circuit PULSES for other network panel fires
Amber LED OFF	Sounder circuit NO RESPONSE for other network panel fires

4 3 4 3 Comms PCB Output Functional Options

If a repeater Comms PCB (TPCA05) has been fitted to the panel, the 6, switched -ve outputs on the PCB can also be independently programmed with a custom response to; Silence Alarms (including, Silence button or input programmed for remote Silence Alarms), Evacuate (including, Resound button, input programmed for Evacuate or 220Ω 'Evacuate' call point), Class Change Input, Alert Input or during Zone Delays.

Enter the above code, and press the ENTER button.

The zone 1 fire LED will light. This indicates the output to be programmed as per the table below.

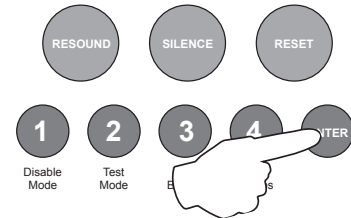

LED 1	LED 2	LED 3	LED 4	LED 5	LED 6
OP 1	OP 2	OP 3	OP 4	OP 5	OP 6

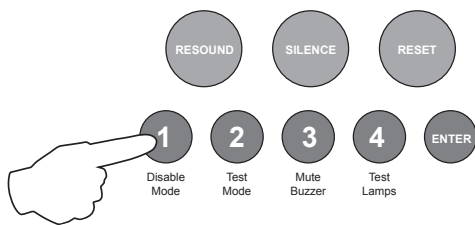

Use button 1 to move the fire LED to the output that requires editing.

With the required output for editing LED lit, press the ENTER button to enter 'editing mode'.

The fire zone 1 LED will now pulse to indicate setting the selected output's response to the first function (Resets on Silence Alarms).

Use button 1 to scroll to the function that requires editing for that output, indicated by a pulsing fire LED 1 - 5 as per table below.

Fire LED (pulsing)	LED 1	LED 2	LED 3	LED 4	LED 5	LED 6
Function	Resets on Silence Alarms	Activates on Evacuate	Activates on Class Change	Activates on Alert	Activates During Delay	Follow Muster Alarm
Amber fault LED (default setting)	OFF	OFF	OFF	OFF	OFF	OFF

Use button 2 to change the response for the output as per table above, indicated by the amber, fault LED, ON, Pulsing or OFF. Then use button 1 to move to the next function if required.

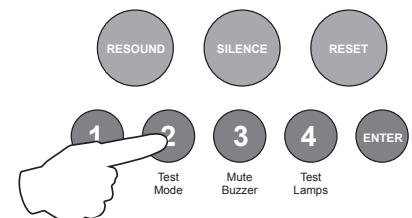

Press the ENTER button to return back to the output selection, indicated by a steady zone fire LED

When finished, press and hold Button 1 for 3 seconds to save setting and exit programming mode.

3 1 1 4 System Diagnostics Mode

System faults can occur if a PCB in the control panel or one of the repeater panels stops working. This may be due to a fault condition, loss of power, software lockup or memory checksum error.

A system fault can also occur if the internal PCB configuration or number of repeater panels has not been correctly set up in the panel wide programming options (2-1-2-3).

If the fault originates from the control panel's main PCB then no further interrogation is possible and the circuit board should be restored or replaced urgently.

The above code has been provided as a quick diagnosis tool to show which additional PCBs, repeater or network slave panels the control panel thinks it should have according to the programming set up, Vs, the actual PCBs and repeater/network panels it can see via it's internal monitoring capacity.

Enter the above code and press ENTER. The control panel will illuminate LEDs to show the set up. The red, fire LEDs indicate the configuration setting. The amber, fault LEDs indicate the presence of the PCBs, repeaters or network slave panels which the control panel thinks it should have according to the programming set up.

See table below.

LED Indicators	DIAGNOSTIC MODE Board Status afer entry 3114	Repeater Status Press Button 1	3114 Slave Panel Status Press Button 1	Local System Fault Press Button 2
FIRE LED OFF	NONE SET	NONE SET	NONE SET	N/A
FIRE LED STEADY	CONFIGURED	CONFIGURED	CONFIGURED	N/A
FAULT LED STEADY	BOARD PRESENT	REPEATER PRESENT	SLAVE PRESENT	N/A
FAULT LED PULSING	N/A	PRESENT WITH LOCAL FAULT	PRESENT WITH LOCAL FAULT	SYSTEM WATCHDOG
Z1	Ext Zone Card 1	Repeater 1	Slave Panel 1	Main Processor PCB
Z2	Ext Zone Card 2	Repeater 2	Slave Panel 2	Display PCB
Z3	Comms PCB (TPCA05)	Repeater 3	Slave Panel 3	Ext Zone Card 1
Z4	Output Card 1	Repeater 4	Slave Panel 4	Ext Zone Card 2
Z5	Output Card 2	Repeater 5	Slave Panel 5	Comms PCB (TPCA05)
Z6	Output Card 3	Repeater 6	Slave Panel 6	Power Supply PCB
Z7	Output Card 4	Repeater 7	Slave Panel 7	Output Card (TPCA08)
Z8		Repeater 8		Power Up

Any differences shown here can then be investigated and corrected either by restoring or replacing PCBs or correcting the configuration settings in the panel wide settings mode 2-1-2-3. Pressing button 1 will show the repeater panel status's, pressing button 1 again will show the status of the network slave panels.

The LEDs will display for 10 seconds and then the panel will automatically exit the diagnosis mode. Pressing button 2 will reveal the origin of a system fault indication.

Note: After power up, the system should be allowed to initialise for 2 - 3 minutes before using this code otherwise false indications could occur. If in doubt, re-enter the code a second time to check.

REPEATER PANEL SETUP & PROGRAMMING

The panel can support up to 8, fully functional repeater panels on the network.

Repeater Comms PCB

To run repeaters, a Comms PCB (TPCA05) must be fitted to the control panel. The repeater panels are supplied with the comms board fitted.

The Comms PCB fits into the control panel on top of the main circuit board where the ribbon cable from the display board is normally plugged.

To fit the Comms PCB, power down the panel, un-plug the display board ribbon cable from the main circuit board and plug the Comms PCB into the socket instead.

A socket is provided on the top of the Comms PCB to re-connect the display board ribbon cable.

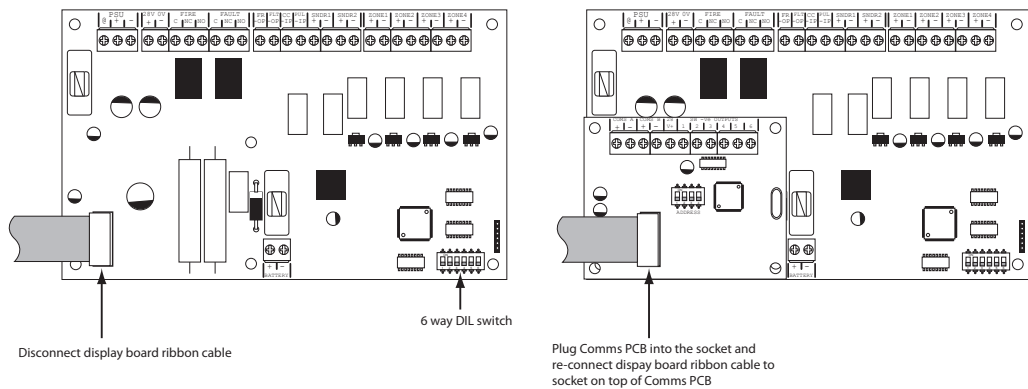

Once the Comms PCB has been fitted, switch 5 on the 6 way DIL switch located on the main circuit board should be switched to the ON position.

With this switch in the ON position the panel will automatically recognise & operate the Comms PCB (TPCA05).

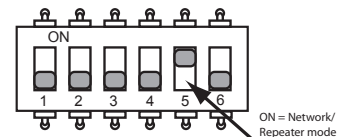

Next, the panel will need to be programmed for the number of repeater panels on the system. See panel wide settings 2-1-2-3 option 2 (Set Number of Repeater Panels on System).

Addressing

Each repeater panel needs to have a separate address. The addressing is done using the 4 DIL switches on each of the Comms PCBs using binary code values, see diagram below.

The address should be set in sequence from 1 - 8, first repeater address 01, next repeater address 02 etc. The control panel should always be address 00 (all switches off).

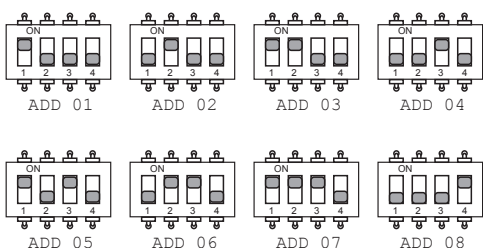

Network System Note:

Repeater panel addresses are parallel to network slave panel addresses on a network system.

I.e. a repeater and a network slave panel can both have address 01 on the network.

Wiring

The repeater panels are designed to be wired in a fault tolerant (fail safe) loop configuration, from comms A to B and back to the main panel again (see diagram). This enables repeater panels to still work if there is a break in the cables.

If replacing an older system where the existing cabling cannot be configured in a loop as shown, it is possible to change the panel back to radial circuit comms monitoring. See panel wide settings 2-1-2-3 option 6 (Repeater Comms Monitoring Type).

Fault Tolerant Loop Wiring

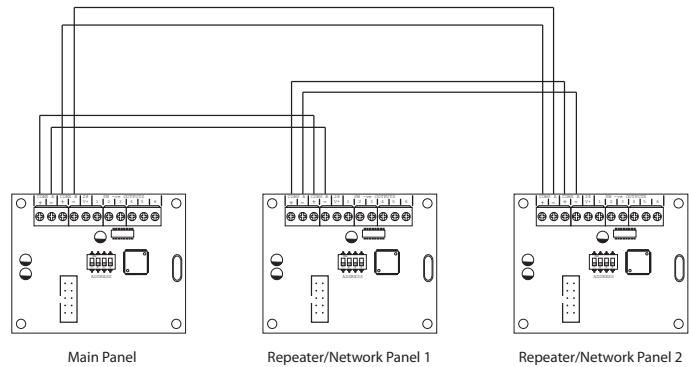

4 4 4 3 Programming Repeater Panels

Programming of all the repeater panels is done from the main control panel.

The repeater panels have 2 inputs located on the main circuit board, Class Change (CC) and Alert (PUL). Switching a negative voltage into these inputs will cause the alarm sounders to operate. The Class Change input (CC) will cause the alarms to sound continuously and the Alert input (PUL) will cause the alarms to pulse.

There are also 6 switch -ve outputs located on the Comms PCB. By default o/p 1 is set to activate on common fire and o/p 2 is set to activate for common fault.

There are 4 programming options available for the inputs and outputs in the repeater panels.

- Outputs 1 - 6 activate on common fire
- Outputs 1 - 6 activate zonally for zones 1 - 6
- Outputs 1 - 6 activate zonally for zones 7 - 12
- Change inputs CC & PUL to power supply fault inputs.

It is also possible in this programming mode to disable the controls on repeater panels, making them passive instead of active and to disable the battery monitoring on the repeater panel if no battery backup is required.

Enter the above code and press ENTER. The zone 1 fire LED will light. This indicates which repeater panel is to be programmed 1 - 8. Use button 1 to move the fire zone LED to the required repeater.

With the required repeater for editing LED lit, press the ENTER button to enter 'editing mode'. The fire zone 1 LED will now pulse to indicate setting of attribute 1 (outputs 1 - 6 common fire) for that repeater.

Use button 1 to scroll to the attribute that requires editing, indicated by a pulsing fire LED 1 - 7 as per table below. Now use button 2 to change the setting indicated by the amber, fault LEDs, ON or OFF. Then use button 1 again to move to the next attribute if required. **See repeater instruction manual for further details of option 7**

Fire LED (pulsing)	LED 1	LED 2	LED 3	LED 4	LED 5	LED 6	LED 7
Attribute	O/P 1 - 6 Common Fire	O/P 1 - 6 Zonal (Zones 1 - 6)	O/P 1 - 6 Zonal (Zones 7 - 12)	Inputs For PSU Fault	Controls Passive	Disable Battery Monitoring	Repeater Mimic Display Mode
Default Setting	OFF	OFF	OFF	OFF	OFF	OFF	OFF

PANEL CONTROLS & INDICATIONS

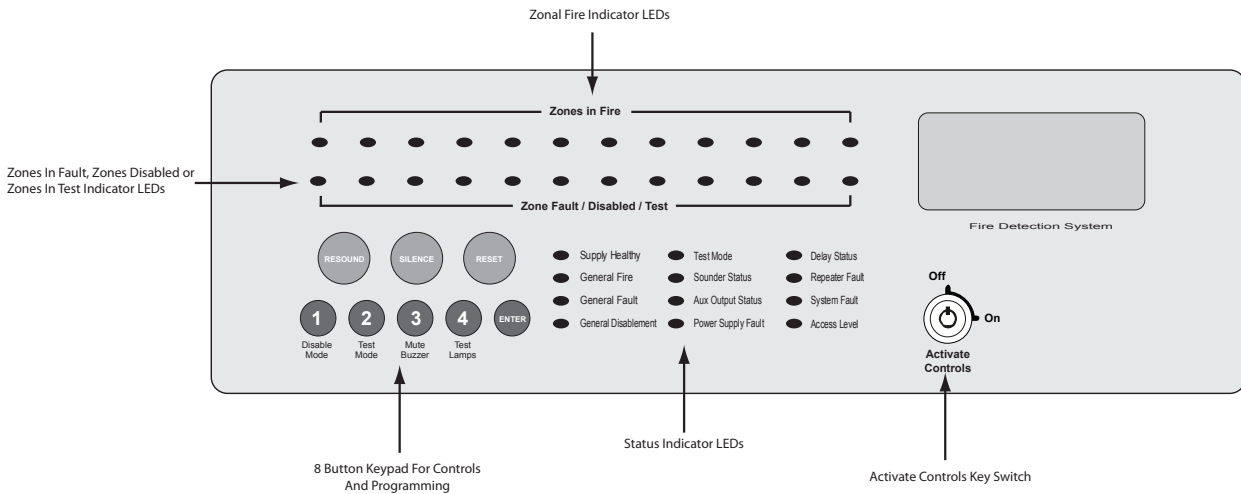

Activate Controls

In normal standby mode the keypad controls are inactive to protect from unauthorised operation. Controls can be activated by using the 'Activate Controls' key switch or by entering a four digit code using the keypad.

The use of a code entry to activate the controls is enabled by default but can be disabled in the Level 3 engineering functions.

To activate the controls using the key switch

Turn the key clockwise to the 'On' position. The 'Access Level' indicator LED will light and all buttons on the keypad will now be operational. To deactivate the controls, turn the key back to the 'Off' position and the 'Access Level' indicator LED will extinguish.

If the key switch is in the 'On' position the keypad will remain active.

NOTE : It is not possible to remove the key in the 'On' position.

To activate the controls using the keypad

Enter the four digit code using buttons 1 - 4. The factory default code is 1-2-3-4 but can be changed in the engineering functions. After entering the four digit code press the 'ENTER' button. The 'Access Level' indicator LED will light and all buttons on the keypad will now be operational.

After activation by code entry, controls will automatically deactivate again after 2 minutes and the panel will return to standby mode.

The test lamps and mute buzzer functions are operational without the need to activate controls.

Status LED Indicators

	LED On	LED Pulsing
Zones in Fire 1 - 12	N/A	Indicates alarm condition in zone.
Zone Fault/Disabled/Test 1 - 12	Indicates zone circuit is disabled or in test mode.	Indicates a fault in the zone circuit.
Supply Healthy:	Indicates mains and/or battery supply is present.	N/A
General Fire:	N/A	Indicates panel is in alarm condition.
General Fault:	N/A	Indicates one or more faults are present.
General Disablement:	Indicates one or more circuits have been disabled.	Indicates disablement selection mode is active.
Test Mode:	Indicates one or more circuits are in test mode	Indicates test mode selection is active.
Sounder Status:	Indicates sounder circuits have been disabled or are in test mode	Indicates a fault on one or more sounder circuits.
Aux Output Status:	Indicates auxiliary outputs have been disabled.	N/A
Power Supply Fault:	N/A	Indicates a power supply, battery or earth fault
System Fault:	Indicates a system failure, panel not functional or the internal PCB configuration has not been set up correctly (see page 26).	Indicates the panel has recovered from a system fault.
Access Level:	Indicates controls are active (access level 2).	Indicates panel is in configuration mode (access level 3).
Repeater Fault:	N/A	Indicates a fault on one or more repeater panels
Delay Status:	Delays are configured	Delay is running
Earth Fault (internal LED)	-ve earth fault	+ve earth fault

Keypad

RESOUND (red):	Use to resound the alarms after they have been silenced. Can also be used to invoke full evacuation.
SILENCE (blue):	Use to silence the sounders during an alarm condition.
RESET (green):	Resets the panel back to standby mode.
1: (Disable Mode)	With controls inactive, use to initialise code entry mode for activation of controls. With controls active, use to disable zones, sounder circuits or aux outputs (see DISABLE MODE section). Also has the numeric value 1 for code entry.
2: (Test Mode)	With controls inactive, use to initialise code entry mode for activation of controls. With controls active, use to put zones or sounders circuits into test mode (see TEST MODE section). Also has the numeric value 2 for code entry.
3: (Mute Buzzer)	Mutes the panels internal fire and fault buzzer. (The buzzer will still blip every 5-6 seconds during a fire or fault condition). This function is operational without the need to activate controls. Also has the numeric value 3 for code entry.
4: (Test Lamps & Buzzer)	Use this button to illuminate all LEDs and sound the internal buzzer to check that they are working correctly. This function is operational without the need to activate controls. Also has the numeric value 4 for code entry.
ENTER:	This button is used to confirm code entries. It can also be used for fault diagnosis (see FAULT DIAGNOSIS section).

Some buttons have other functions within the engineering facilities. These functions are described in the relevant sections.

DISABLE MODE

Disable Mode is used to disable or isolate individual zone circuits or all sounder circuits, all auxiliary outputs and any delays to outputs.

To initialise Disable Mode firstly activate the controls by turning the key switch or by entering the four digit code. Then press and hold the Disable Mode button (1) for 3 seconds.

After 3 seconds the panel will bleep and the General Disablement LED and Zone 1 Fault LED will pulse slowly, indicating that Zone 1 is in disable selection mode.

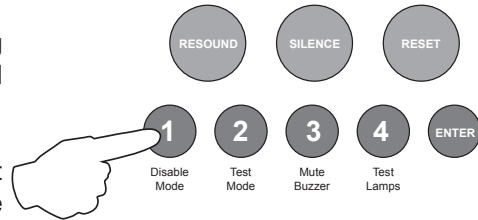

Pressing the Disable Mode button again will move disable selection mode to Zone 2 and the Zone 2 Fault LED will be pulsing instead. Subsequent presses will move the selection to Zones 3 - 12, dependant on the number of zones fitted to the panel. I.e up to zone 4 on a 4 zone, 6 on a 6 zone, 8 on a 8 zone etc.

After the last available zone the next press will move the selection mode to the sounder circuits, indicated by the Sounder Status LED and then to the Aux outputs, indicated by the Aux Output Status LED and finally to the Delay LED. Pressing the button once more will move the selection back to Zone 1 again.

When the desired circuit, outputs or delays to be disabled is indicated by a slow pulsing LED, use the ENTER button to select it. Once selected the indicator LED will change to a rapid pulse. Pressing ENTER again will toggle the circuit between disabled and enabled. Then use Disable Mode button again to move to the next circuit. Any or all circuits, outputs or delays can be disabled simultaneously.

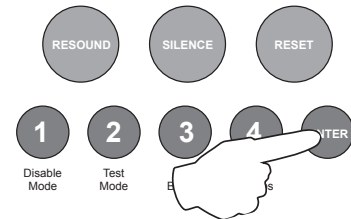

When all disablements have been set, press and hold the Disable Mode button for 3 seconds again. This will exit the disable selection mode and the panel will return to standby. All disabled circuits and the General Disablement will now be indicated by a steady LED.

To enable the circuits again, repeat the above process using the Disable Mode button to select the circuit and the ENTER button to remove the disablement.

Tip:

With the controls active, pressing the Disable Mode button briefly will reveal which circuits are disabled (as opposed to in test mode). This is useful if using Disable Mode and Test Mode at the same time.

TEST MODE

Test Mode is used when testing the fire alarm system. In test mode the devices in the zone(s) in test, detectors and call points etc, can be activated and the panel will automatically reset, enabling the system to be tested by one person. It is possible to test head removal monitoring and to test the system with or without the sounders.

To initialise Test Mode, firstly activate the controls by turning the key switch or by entering the four digit code. Then press and hold the Test Mode button (2) for 3 seconds.

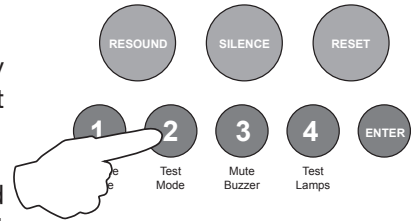

After 3 seconds the panel will bleep and the Test Mode LED and Zone 1 Fault LED will pulse slowly, indicating that Zone 1 is in test selection mode. The Sounder Status LED will also be pulsing rapidly, this indicates that the test will be **with** sounders. (Test mode without sounders is explained below)

Pressing the Test Mode button again will move test selection mode to Zone 2 and the Zone 2 Fault LED will be pulsing instead. Subsequent presses will move the selection to Zones 3 - 12, dependant on the number of zones fitted to the panel. I.e up to zone 4 on a 4 zone, 6 on a 6 zone, 8 on a 8 zone etc..

After the last available zone the next press will move the selection mode to the sounder circuits, indicated by no Zone Fault LEDs on. This position selects whether or not the sounders will ring during test. Pressing the button once more will move the selection back to Zone 1 again.

When the desired zone to be tested is indicated by a slow pulsing LED, use the ENTER button to select it. Once selected the indicator LED will change to a rapid pulse. Pressing ENTER again will toggle the zone between in and out of test. Then use Test Mode button again to move to the next zone. Any or all zones can be in test mode simultaneously.

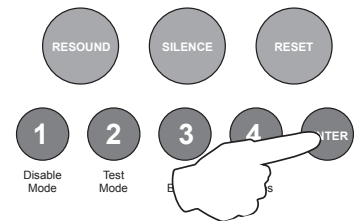

When at the sounder status position, use the ENTER button to toggle between testing with or without sounders. A rapid pulse = with sounders (default), a slow pulse = without sounders.

When all zones to be tested have been selected, press and hold the Test Mode button for 3 seconds again. This will exit the test selection mode. All zones in test and the Test Mode will now be indicated by a steady LED.

To take zones out of test mode, repeat the above process using the Test Mode button to select the zone and the ENTER button to change the status.

Test Mode With Sounders

Activation of a call point or detector - sounders will pulse twice, device is automatically reset.
Removal of a detector - sounders will pulse once.

Test Mode Without Sounders

Activation of a call point or detector - panel buzzer and LED response only, device is automatically reset.

Tip:

With the controls active, pressing the Test Mode button briefly will reveal which circuits are in test mode (as opposed to disabled). This is useful if using Disable Mode and Test Mode at the same time.

FAULT DIAGNOSIS

If the panel has detected a fault on the system the General Fault LED will be illuminated and the internal fault buzzer will sound. Secondary LEDs will also be illuminated depending on the location of the fault.

Pressing and holding the ENTER button will reveal more detailed information about the location and type of fault.

This function will not work if the panel is in a fire condition. If no faults exist pressing the ENTER button will have no effect.

This function is operational only when controls are not active.

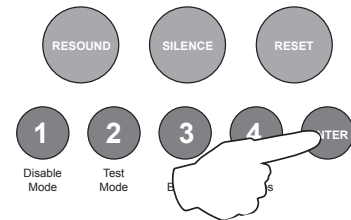

The following table shows details of the indications in fault diagnosis mode:

LED Indicator & State before pressing ENTER	LED Pulsing after pressing ENTER	LED Steady after pressing ENTER	LED Off after pressing ENTER	Location
Zone 1 Fire LED (off)	Sounder circuit 1 short circuit	Sounder circuit 1 open circuit	OK	Main PCB SNDR 1
Zone 2 Fire LED (off)	Sounder circuit 2 short circuit	Sounder circuit 2 open circuit	OK	Main PCB SNDR 2
Zone 3 Fire LED (off)	Sounder circuit 3 short circuit	Sounder circuit 3 open circuit	OK	High Spec Extension Zone Card
Zone 4 Fire LED (off)	Sounder circuit 4 short circuit	Sounder circuit 4 open circuit	OK	High Spec Extension Zone Card
Zone 5 Fire LED (off)	Sounder circuit 5 short circuit	Sounder circuit 5 open circuit	OK	High Spec Extension Zone Card
Zone 6 Fire LED (off)	Sounder circuit 6 short circuit	Sounder circuit 6 open circuit	OK	High Spec Extension Zone Card
Zone 1 - 4 Fault/ Disabled/Test LED (pulsing)	Zone # short circuit	Zone # open circuit	(slow pulse) Zone # detector removed	Main PCB Zones 1 - 4
Zone 1 - 4 Fault/ Disabled/Test LED (steady)	N/A	N/A	Zone # disabled or in test mode	
Power Supply Fault LED (pulsing)	Mains failure	Battery failure or high impedance	Voltage fault	Main PCB

FUNCTIONALITY DURING A SYSTEM FAULT

A system fault is indicated when a processor controlling a function in the panel has a watchdog time out or processor failure. In the event of a system fault the particular board affected may not be functional. The following indications may be observed.

Display Board

System Fault LED only continuous and continuous buzzer sound. Display board TPCA03 is halted and no other indication or control is possible. Fault relay and fault output are activated. If a fire occurs alarm sounders and outputs will still function.

Main Board or zone extender boards

System Fault LED continuous and General Fault LED pulsing and continuous buzzer sound. Main board, or extender card if fitted are halted. Fault relay is activated. Alarms may be activated on the unaffected board.

Repeater Comms Board

System Fault LED continuous and General Fault LED pulsing and Repeater Fault LED continuous. The Comms Board TPCA05 is halted. Fault relay and output are active, and repeater panels will cease to function. Fire alarms can still be detected and controlled by the panel.

System Fault recovery

System Fault LED pulsing and General Fault LED pulsing along with a pulsed buzzer (fault tone) a system fault has occurred and the affected board has recovered. The indication will remain until the panel is reset.

The following section is a summary of the requirements in BS5839 Part 1

For comprehensive information a copy of BS5839 Part 1 can be purchased from the British Standards Institution via their web site at www.bsi-global.com.

THE NEED FOR MAINTENANCE

Your Fire Alarm System is working 24 hours a day, 365 days a year. The detectors and control & indicating panel are operating continuously and the fire alarm circuits are constantly monitored.

Legislation such as the Regulatory Reform (Fire Safety) Order 2005 and other legislation protecting both employees and the public require premises operators to conform with standards for Fire Alarm Systems.

It is a requirement of BS 5839 Part 1 that the system is subject to periodic inspection and servicing so that faults are identified, preventive measures can be taken to ensure the continued reliability of the system, false alarm problems are identified and suitably addressed, and the user is made aware of any changes to the building that affect the protection afforded by the system.

The inspection and servicing recommendations in this clause should be carried out by a competent person. A 'Competent Person' is a person or fire alarm servicing organisation with specialist knowledge of fire detection and fire alarm systems, including knowledge of the causes of false alarms, sufficient information regarding the system, and adequate access to spares.

The period between successive inspection and servicing visits should be based upon a risk assessment, taking into account the type of system installed, the environment in which it operates and other factors that may affect the long term operation of the system. The recommended period between successive inspection and servicing visits should not exceed six months. If this recommendation is not implemented, it should be considered that the system is no longer compliant with this part of BS 5839

DUTIES OF THE RESPONSIBLE PERSON

The system user needs to appoint a single, named member of the premises management to supervise all matters pertaining to the fire detection and fire alarm system. The role of this person is to ensure that the system is tested and maintained in accordance with the recommendations of BS 5839 Part 1, that appropriate records are kept and that relevant occupants in the protected premises are aware of their roles and responsibilities in connection with the fire detection and fire alarm system.

This person also needs to ensure that necessary steps are taken to avoid situations that are detrimental to the standard of protection afforded by the system and to ensure that the level of false alarms is minimized.

ROUTINE MAINTENANCE & TESTING

DAILY

The 'Responsible Person' should check the control panel to make sure no faults or pre-alarm conditions are indicated and that the green 'Supply Healthy' lamp is lit.

WEEKLY

The Fire Alarm System should be tested on a weekly basis as recommended in BS5839 Part 1 clause 44.2.

Every week a manual call point should be operated during normal working hours. The weekly test should be carried out at approximately the same time each week. Instructions to the occupants should be that they report any instance of poor audibility of the fire alarm signal.

A different manual call point should be used at the time of every weekly test so that all manual call points in the building are tested in rotation over a prolonged period.

The result of the weekly test and the identity or location of the manual call point used should be recorded in the system log book.

WEEKLY TEST

The call point test key should be inserted firmly and deliberately into the bottom of the manual call point. Once activated it may be necessary to wait up to four seconds before the alarms sound.

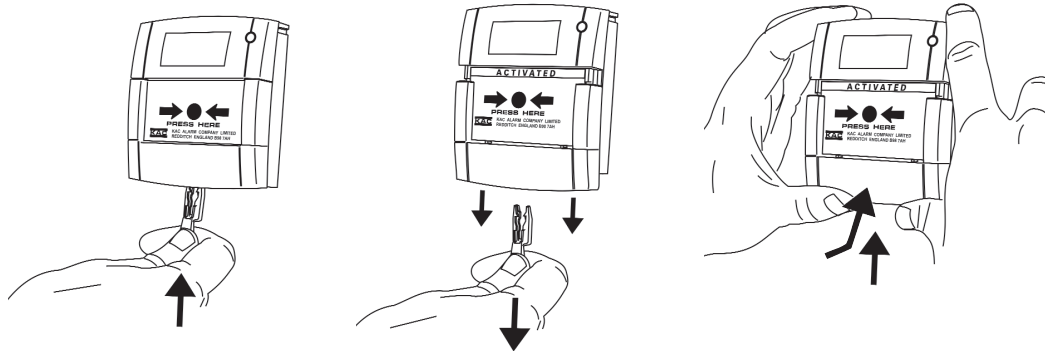

Your manual call points may not be the same as the ones described above. If not please refer to your service and maintenance company for instructions.

Note:

Before testing the fire alarm system it may be necessary to isolate ancillary outputs.

It is essential that any alarm receiving centre is contacted immediately before and immediately after, the weekly test to ensure that unwanted alarms are avoided and that fire alarm signals are correctly received at the alarm receiving centre.

PERIODIC INSPECTION & SERVICING

Inspection & servicing should only be carried out by a ‘Competent Person’ who has sufficient knowledge to check the whole system. This would normally be a qualified electrical contractor or fire alarm specialist.

Inspection & servicing visits are normally conducted on a quarterly basis unless such factors as a dirty environment warrant servicing on a more regular basis. The maximum period between inspections must not exceed six months.

Recommendations of BS5839-1 for periodic service visits include:

- Every device on the system should be tested annually. The testing of each device can be split between periodic visits but with a minimum of one detector or call point tested on each circuit, per visit.
- On each visit the ‘Competent Person’ should check the record of false alarms. Any persistent occurrence should be investigated and corrective action taken as appropriate.
- Battery and connections should be examined and load tested to check serviceable condition and that they are not likely to fail before the next service visit.
- All other devices and control & indicating equipment should be checked for correct operation and any faults should be recorded and rectified.
- Details of the service visit must be recorded in the log book

EVERY FOUR YEARS

Renew the sealed lead acid batteries and record the fact in the log book

USER INSTRUCTIONS

If an alarm condition is present YOU MUST FOLLOW YOUR NORMAL FIRE DRILL PROCEDURES.

A responsible person should then:-

1. Check the control panel to see which area or zone has caused the system to go into alarm. This will be indicated by a pulsing red LED on the front of the control panel.
2. Go to the area which has caused the alarm to check if a fire exists.
3. Only when it is safe to do so should the alarms be silenced. Activate the controls by turning the key switch or by entering the four digit code (see Activate Controls in the OPERATING section) and press the (blue) SILENCE ALARMS button (fig 1). To sound the alarms again press the (red) RESOUND button (fig 2).
4. In the event of a false alarm look for the device that has caused the alarm. A detector will have a red LED lit, or check to see if a call point glass is broken (if so replace the glass or call an engineer).
5. When fully satisfied that there is no fire, return to the control panel and press the (green) RESET button, (fig 3). The panel display should return to normal and only the green SUPPLY HEALTHY LED should be lit on the control panel.

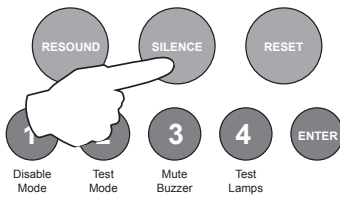

fig 1

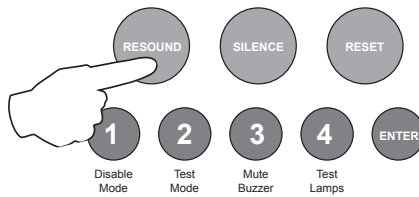

fig 2

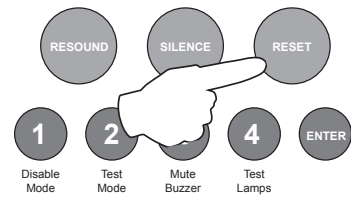

fig 3

If the system continues to false alarm, call an engineer

Fault Condition

If a buzzer is sounding in the control panel but the sounders or bells are not ringing, then there is either a fault on the system, or zones / sounders have been disabled. CALL AN ENGINEER

The internal fault buzzer can be silenced by pressing MUTE BUZZER (button 3 on the keypad). DO NOT RESET THE SYSTEM UNTIL AN ENGINEER HAS INVESTIGATED THE FAULT.

www.haes-tech.com