



SZAOV CONTROL PANEL INSTALLATION, COMMISSIONING & OPERATING MANUAL

This manual covers the installation, programming and commissioning of the Single Zone Automatically Opening Vent Control Panel (SZAOV)

INTRODUCTION



2797-CPR-747546



Haes Technologies Ltd, Unit 3, Horton Industrial Park, West Drayton, Uxbridge, UB7 8JD

21

Model Number

SZAOV-1001

CPR Number

2797-CPR-747546

European Standard BS EN 12101-10:2005

Smoke and heat control systems – Part 10: Power supplies

Haes Technologies Ltd declare that the products identified above conform to the essential requirements specified in the Construction Products Regulation CPR305/2011/EU.

In addition, the product complies with the following:

2014/35/EU, Low Voltage Directive

2014/30/EU, Electromagnetic Compatibility Directive

BS EN 61000-6-3:2007 + A1:2011, Electromagnetic Compatibility (EMC) General Standards. Emission standard for residential, commercial & light industrial environments.

BS EN 12101-2:2017 Smoke and heat control systems. Natural smoke and heat exhaust ventilators

This product has been designed to comply with the requirement of the low voltage safety and the EMC directives. Failure to follow the instructions may compromise its adherence to this standard.

List of optional functions with requirements:

Product: Single Zone Automatically Open Vent Control Panel BS EN12101-10: 2005	
Intended use: Smoke and heat control systems	
Essential Characteristics	Requirement clauses in this European Standard
Operational reliability	6 and 7
Performance parameters under fire conditions	4.1
Response time	4.1 and 6.2.2

SAFETY

IMPORTANT NOTICE

PLEASE READ THIS MANUAL CAREFULLY BEFORE HANDLING THE EQUIPMENT AND OBSERVE ALL ADVICE GIVEN WITHIN IT.

THIS PARTICULARLY APPLIES TO THE PRECAUTIONS NECESSARY TO AVOID ELECTRO-STATIC DISCHARGE



Important Safety Notes

The panel is safe to operate provided it has been installed in compliance with the manufacturer's instructions and used in accordance with this manual.

Hazardous voltages are present inside the panel—DO NOT open it unless you are qualified and authorised to do so. There is no need to open the panel's enclosure except to carry out commissioning, maintenance and remedial work. This work must only be carried out by competent service personnel who are fully conversant with the contents of the panel's installation manual and have the necessary skills for maintaining this equipment.

The product must be installed, commissioned and maintained for operation in accordance with the instructions and the applicable wiring codes of practice and national standard regulations for fire systems appropriate to the country and location of the installation.

This equipment is designed to be operated from 230VAC 50/60 Hz mains supplies and is of Class I construction. As such it must be connected to a protective earthing conductor in the fixed wiring of the installation. Failure to ensure that all conductive accessible parts of this equipment are adequately bonded to the protective earth will render the equipment unsafe.

Disclaimer

No responsibility can be accepted by the manufacturer or distributors of this fire alarm panel for any misinterpretation of an instruction or guidance note or for the compliance of the system as a whole. The manufacturer's policy is one of continuous improvement and we reserve the right to make changes to product specifications at our discretion and without prior notice. E & O E.

Warnings

	<p>Before installation, refer to the Ratings shown on the label inside the product and to the 'Specifications Chart' in this document. If you are unclear on any point, please DO NOT proceed. Contact the manufacturer or supplier for clarification and guidance.</p> <p>Only Trained service personnel should undertake the Installation, Programming and Maintenance of this equipment.</p>
--	---

Cautions

Equipment Guarantee



This product has been manufactured in conformance with the requirements of all applicable EU Council Directives and is not guaranteed unless the complete system is installed and commissioned in accordance with the laid down national standards by an approved and competent person or organisation.

This product has been designed to comply with the requirements of the Low Voltage Safety and the EMC Directives. Failure to follow the installation instructions may compromise its adherence to these standards.



Waste Electrical and Electronic Equipment Directive

TABLE OF CONTENTS

INTRODUCTION	2
SAFETY	4
IMPORTANT NOTICE	4
Important Safety Notes	4
Disclaimer	4
Warnings	4
Cautions	5
TABLE OF CONTENTS	6
PRODUCT OVERVIEW	8
Product codes and features	8
Input and output keys	8
Quiescent and alarm current details for standby battery calculations	8
SZAOV Cabinet	9
Circuit Boards	10
PCA034 Master PCB	10
PCA02-AOV – LED Display & Controls PCB	10
PIR/BMS (Plug-in) Card – PIR-0-10-3041-212 (Optional)	10
Technical Specification	11
General Specification	11
Power Supply Specification – PSM3 - 24 (3 Amp)	12
Electrical Specification - Inputs & Outputs	14
Electrical Specification - Inputs & Outputs	15
Circuit Description/Function	16
TPCA34 – SZAOV Master Card	16
PIR/BMS Plug-in Card (2-Way) – PIR-0-10-3041-212 (TPCA029) (Optional)	19
Detector Circuit Conventional System Schematic	21
Detector Circuit Twin Wire System Schematic	22
INSTALLATION	23
Safety	23
ESD Precaution	24
Installing the System	24
General	24
Environment	24
Mounting the Cabinet	24
Mains Connections	25
Connecting the Batteries	26
Battery Charging Voltage Checks	26

SETUP AND PROGRAMMING	27
Twin Wire Mode.....	27
DIL Switch Options	28
Level 3 Engineering Options	29
Clear All Disablements	29
Miscellaneous Program Options	30
OPTION 1 (Vent Open LED) Change / Remove Keypad Access Code	32
OPTION 2 (Vent Closed LED) Set Motor Opening Time.....	30
OPTION 3 (Vent Open LED and Vent Closed LED) Set Motor Closing Time.....	30
OPTION 4 (Input LED) Disable Battery Monitoring	31
OPTION 5 (Detector LED) Disable Muted Tone Beeps	31
Input Circuit Function Settings	32
Thermostat Controlled Ventilation Mode	34
Type 'A' dependency mode	35
PANEL CONTROLS & INDICATIONS	36
Panel Display	36
OPERATING	36
Activate Controls	36
Status LED Indicators.....	37
Keypad.....	38
DISABLE MODE.....	39
TEST MODE	40
FUNCTIONALITY DURING A SYSTEM FAULT	40
SERVICE & MAINTENANCE	41
The Need for Maintenance	Error! Bookmark not defined.
Duties of the Responsible Person	Error! Bookmark not defined.
Routine Maintenance and Testing	Error! Bookmark not defined.
Daily.....	Error! Bookmark not defined.
Weekly.....	Error! Bookmark not defined.
Periodic Inspection and Servicing	Error! Bookmark not defined.
EVERY FOUR YEARS	Error! Bookmark not defined.
SCHEDULE OF TESTING	42

PRODUCT OVERVIEW

SZAOV is a single zone Automatic Opening Vent control panel. The panel is available with a 3 Amp output, for controlling small loads.

The panel is supplied in a cabinet with space for two 7Ah batteries.

The panel is supplied in a sheet steel enclosure suitable for wall mounting with a hinged, lockable front access door. The panel can be semi recessed using a suitable recessing bezel. Cable entry is via 20mm knockouts located at the top and rear of the cabinet.

Different key types are used for the door lock and the 'activate controls' key switch. It is also possible to enable the controls via a 4-digit code entry, if preferred. An eight-button keypad is used to control the system and allow access to the function options. The three main buttons, 'OPEN VENT' (red), 'CLOSE VENT' (blue) & 'RESET' (green) being much larger and colour coded to assist the end users.

The panels are designed to control a single 24VDC motorised vent which uses polarity reversal to control direction. A 1 Amp output is also provided for the control of magnetic vents or other purposes.

The power supply of the SZAOV panel is approved to European standards BS EN 12101-10. The panel has a reliability classification of Re 50.

This product has been designed and manufactured in the United Kingdom.

Product codes and features

Power	Enclosure Size	Batt Capacity	Inputs	Outputs
3 Amp	308W x 260H x 80D	7Ah	A, S, E, F	M, ACT(x1), CA, CF

Input and output keys

Inputs		Outputs	
A	Alarm input circuit	M	Magnetic vent
S	Smoke detection circuit	ACT	Actuator
R	Rain sensor	CA	Common alarm contacts
P	PIR sensor	CF	Common fault contacts
E	External control switch	BMS	BMS 0-10v status
F	Fireman override		
B	BMS 0-10v control		

Quiescent and alarm current details for standby battery calculations

Standby Current	Alarm Current
65mA	106mA

SZAOV Cabinet

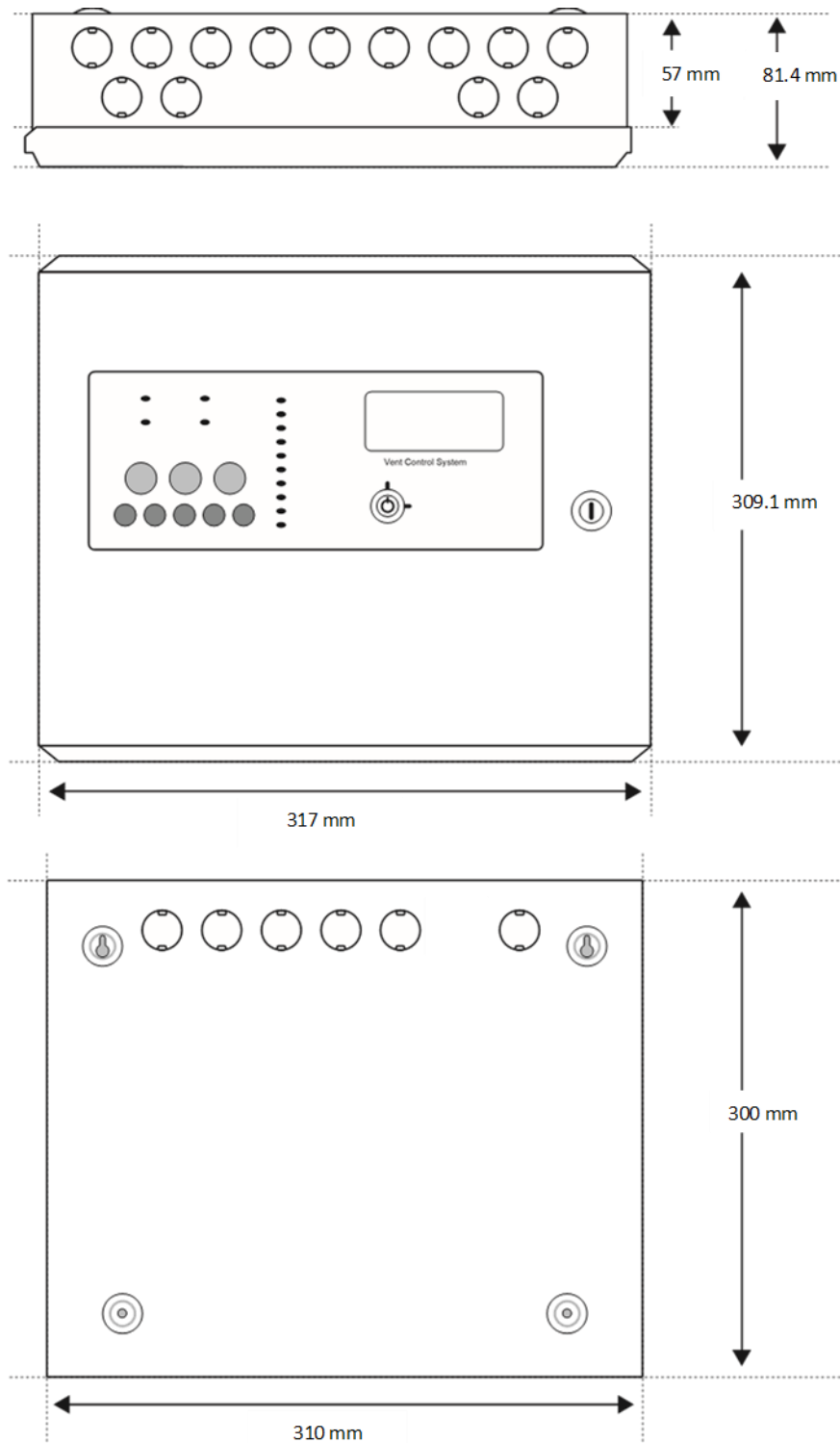

Circuit Boards

PCA034 Master PCB

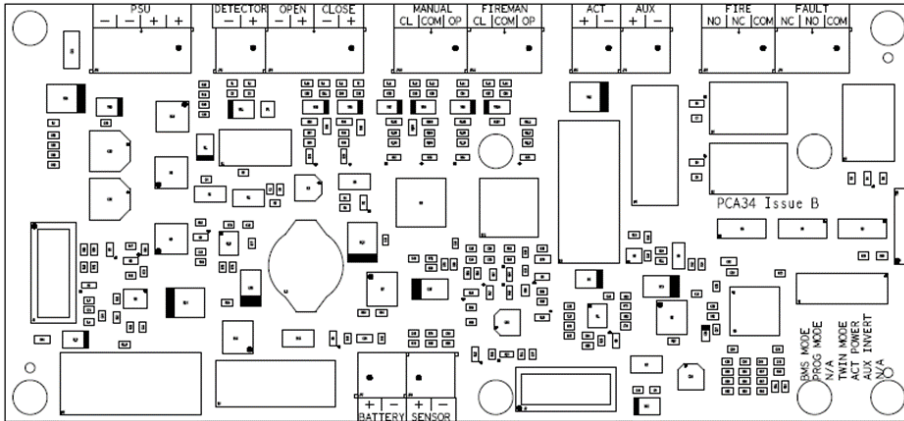

PCA02-AOV – LED Display & Controls PCB

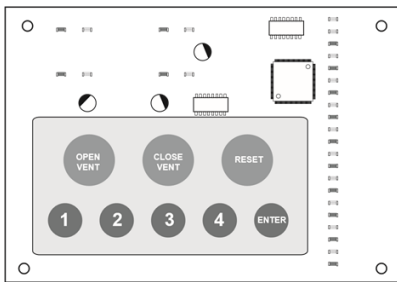

PIR/BMS (Plug-in) Card – PIR-0-10-3041-212 (Optional)

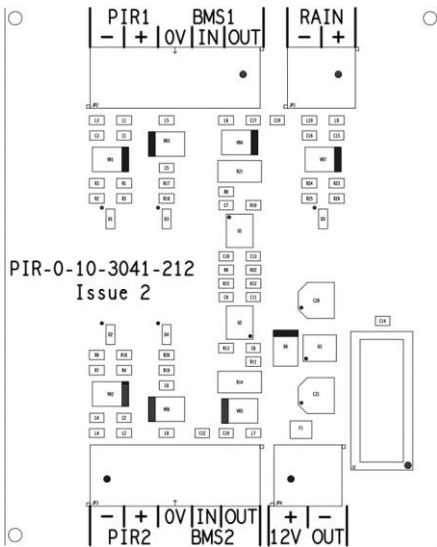

Technical Specification

General Specification	
Enclosure	Steel IP30. Epoxy powder coated Interpon Radon, silver grey
Temperature range:	-5°C to +40°C
Maximum Relative Humidity:	95%
Number of conventional/twin wire detection circuits	1
Conventional/twin wire detector compatibility	Apollo: S65, Orbis. / Hochiki CDX. / Nittan EV
Cabling	Fire resistant screened cable, minimum size 1mm ² . Max cable length 1Km (20 Ohm). Fire Burn, FP200 or equivalent (max capacitance 1uF, max inductance 1 millihenry). Suitable cable glands must be used
Terminal capacity	0.5mm ² to 2.5mm ² solid or stranded wire.

Power Supply Specification – PSM3 - 24 (3 Amp)		
Mains supply	230VAC +10% / -15%	50Hz max current 1.2 Amp
Mains supply fuse	4 Amp (F4A 250V)	Not accessible for servicing. Internal to switched mode power unit
Power supply rating	3 Amps total including battery charging	Maximum load shared = 3 Amp
Power supply output voltage	22 – 29.5VDC	Set for batt charge O/P - 29V
Maximum ripple voltage	120mV p-p	
Min current supplied by PSU (I _{min})	40mA	
Maximum continuous load for battery standby	I _{maxA} : 70mA	I _{maxB} : 2 Amp
Battery size and type	2 x 7Ah 12volt VRLA Yuasa NP range	Batteries shall comply to BS 62368-1 requirements. Fire rated batteries shall be used.
Battery charging voltage	27.3VDC nominal	
Battery charging output current	700mA Current limited	
Max current drawn from batteries	3 Amps. Battery fuse 5A HBC 20mm	
Battery high impedance fault (Batt Hi Z)	Resistance > 1 Ohm	1-hour reporting time

3 AMP Power Supply Module

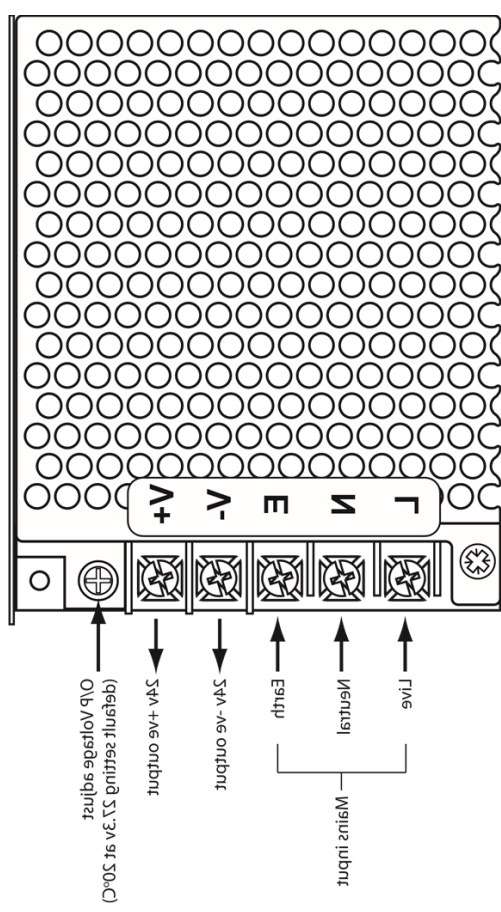

Electrical Specification - Inputs & Outputs		
TPCA034 Master Card		
PSU - - + +	28VDC supply input. Diode protected for reversal and independent short circuit	Max input current; 5 amps. Input voltage 22VDC to 32VDC
DETECTOR - +	Fire alarm zone circuit. Conventionally wired detection circuit or Twin Wire combined detection / sounder circuit. 6K8Ω 5% 0.25W EOL resistor.	Monitoring current limit 50mA, fused @ 500mA. Typical max load 22 alarm devices @ 18mA each.
OPEN - +	External input to open the vent. 2K7 alarm. 6K8Ω 5% 0.25W EOL resistor.	Monitoring current limit 1.5mA, unfused.
CLOSE - +	External input to close the vent. 2K7 alarm. 6K8Ω 5% 0.25W EOL resistor.	Monitoring current limit 1.5mA, unfused.
MANUAL CL COM OP	Manual inputs to control the vent during standby conditions. 2K7 signal. 6K8Ω 5% 0.25W EOL resistor on each input to COM	Monitoring current limit 3mA for each input, unfused.
FIREMAN CL COM OP	Fireman inputs to control the vent during alarm conditions. 2K7 signal. 6K8Ω 5% 0.25W EOL resistor on each input to COM	Monitoring current limit 3mA for each input, unfused.
ACT + -	Dual polarity reversal actuator drive outputs, 28VDC. Max 8A. Max. inrush current of 20A for 2 seconds	Monitoring current limit 1.5mA. O/C > 10K, S/C < 10R Trip current set at 20A for 2 seconds then set at 8A.
AUX + -	Maintained magnetic vent output, 28VDC. Max 1 Amp.	Fused 1 Amp, 20mm glass quick blow fuse.
FIRE NO NC COM (Common Fire relay)	Alarm relay contact. Clean C/O. Max 3A at 30VDC.	Unfused.
FAULT NC NO COM (Common Fault relay)	Maintained fault relay contact. Clean C/O Max 3A at 30VDC.	Unfused

SENSOR + -	Temperature Sensor - 10K at 25degrees.	
BATTERY + -	Battery charging output. 27.3VDC nominal, 700mA current limited	

Electrical Specification - Inputs & Outputs		
PIR-0-10-3041-212 (TPCA029) - PIR/BMS Plug-in Card		
PIR 1 + -	The input requires a 10K Ω impedance to trigger, with a 6K8 Ω 5% 0.25W EOL resistor	Monitoring current limit 14mA, unfused
BMS 1 (0V IN OUT)	Building Management System positional voltage input, 10% steps of motor time.	Max 10VDC, 75K Ω impedance
Rain +/-	Rain sensor signal input. 2K7 alarm. 6K8 Ω 5% 0.25W EOL resistor.	Monitoring current limit 14mA, unfused
12V +/-	12VDC supply output for PIR power	12VDC, fused at 100mA resettable fuse.

Circuit Description/Function

TPCA34 – SZAOV Master Card

PSU (- - + +)

Monitored 28VDC input from power supply module. Diode protected for reversal and independent short circuit. Maximum input current, 5 Amps. Input voltage 22 to 32VDC.

DETECTOR (- +)

Conventional / Twin Wire fire alarm zone circuit input (latching by default). Monitored via a 6K8 end of line resistor. Monitoring current limit is 50mA, fused at 500mA. Up to 20 detectors may be used on this circuit. These may use schottky diode bases for detector removal monitoring, ensuring that if a detector is removed, other devices on the cable are still functional.

The circuit can be used in 'Twin Wire' mode by selection of DIL switch 4 on the main PCB. This allows use of 24v alarm sounders in reverse polarity on this circuit. Note: In this mode the detectors require special 'Sav-Wire' bases.

An alarm on the detector circuit will activate the vent outputs, in the same way as activation inputs from the Fireman switch, local vent control switches, or other activation inputs.

Some programming options are available for this circuit, please refer to the programming and set up section.

OPEN (- +) | CLOSE (- +)

Fused motor drive inputs from an external fire or SZAOV panel, not normally powered (non-latching by default). Used to force the vent either open or closed, depending on its current condition, when the external panel goes into an alarm condition.

Alarm activating input; 2K7 alarm, 6K8 Ohm, 5% 0.25W, EOL resistor. Monitoring current limit 14mA, unfused.

MANUAL (CL COM OP)

Control inputs for manual operation of the vent by a local 3-way control switch. Moves the vent by 10% increments when activated for less than 3 seconds, otherwise the vent is fully operated.

- CL – Close vent
- COM - Common reference
- OP – Open vent

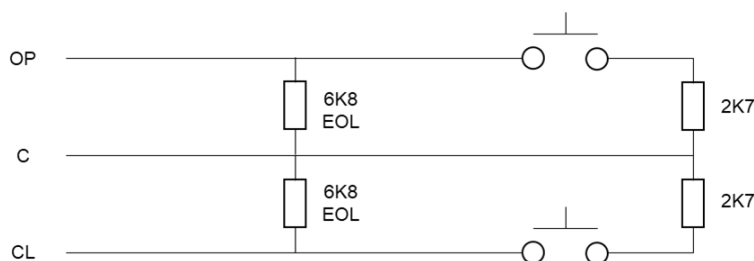

These inputs can be configured to also operate as a thermostatic control of the vent. Replace the 2K7 resistor in the diagram above with a 10K resistor and the vent will open or close to a pre-configurable position.

FIREMAN (CP COM OP)

Control input from external 3-way fireman control switch, for manual control of the vent:

- CL Activates the vent output (fully close vent)
- COM Common reference
- OP Activates the vent output (fully open vent)

In default condition, operation of this switch will fully open/close the vent, overriding local switch settings/vent positions.

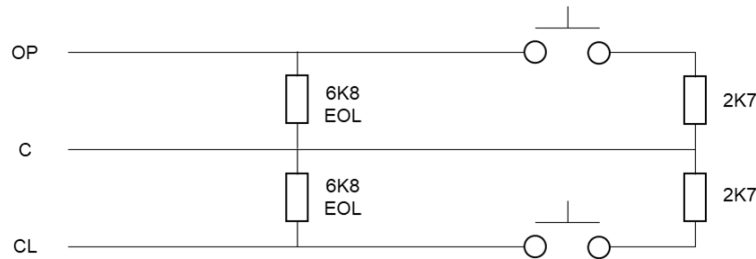

Note: If neither input is activated, vent follows panel automatic control.

ACT (+ -)

Dual polarity reversal vent drive actuator outputs - 28VDC, max 8A, protected by a current trip circuit. Not normally powered. Operated by the inputs from either the main fireman switch, or the local vent control switch; for a configurable time-period of 10 to 300 seconds. The default setting is 60 seconds, during configuration of the panel, this should be set to the time-period required to open/close the vent fully. Polarity is reversed for vent closure.

The resistance of the actuator is monitored. When above $10\text{K}\Omega$ it is considered an open circuit and less than 10Ω it is considered a short circuit. This monitoring is only active when the actuator is in the fully open or fully closed position. A configuration option allows the short circuit monitoring to be completely suppressed. This option might not meet the requirements of local regulations. When used in this mode, connecting resistances of less than 1Ω can cause damage to the circuitry of the actuator driver.

On commissioning, the vent should be set to the fully closed position prior to connection. The actuator outputs may be changed to a continuous, maintained operation using DIL switch 3, 'ACT POWER'. The control logic can be inverted using DIL switch 1, 'ACT INVERT'.

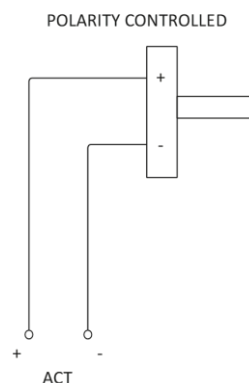

AUX (+ -)

A maintained magnetic vent 28v output for external magnetically controlled devices. Switches off to release magnet in the alarm condition. The output can be inverted using DIL switch 2 'AUX INVERT' on the main PCB.

May also be used as an alternative vent auto close output.

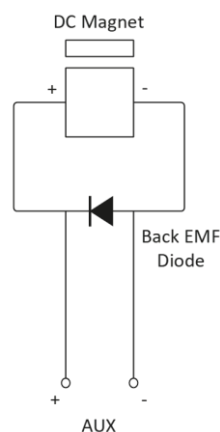
**FIRE (NO NC COM)**

Common alarm changeover relay contacts, max 3A at 30VDC (unfused). Activates when an alarm condition exists on the open/close input or detector circuit.

FAULT (NC NO COM)

Common fault signal changeover relay contacts, max 3A at 30VDC (unfused). Normally energised (failsafe) contacts change-over when any fault is active on the panel or in the event of total power loss.

SENSOR (+ -)

Connections for battery temperature sensor.

BATTERY (+ -)

Output connections for 7Ah 12Volt batteries charging (temperature compensated). 27.3VDC output at 20C, Max. charging current: 700mA.

PIR/BMS Plug-in Card (2-Way) – PIR-0-10-3041-212 (TPCA029) (Optional)

Although the PIR card is designed as a two-way card, when used on the SZAOV panel only one side of PIR and BMS connectors can be used. This means only one PIR can be fitted in the system.

PIR 1/PIR 2 (+ -)

The PIR input is available to monitor a typical security type PIR with N/C alarm and tamper contacts. The PIR requires a 12VDC supply, taken from the boards 12V output. The input requires a 10K Ω impedance to trigger, with a 6K8 Ω 5% 0.25W EOL resistor. Monitoring current limit is 14mA, unfused.

When operated, the PIR alarm prevents the vent from closing to guard against entrapment injury. The PIR should be mounted in accordance with the manufacturer's instructions, to detect any presence in the vicinity of the entrapment risk.

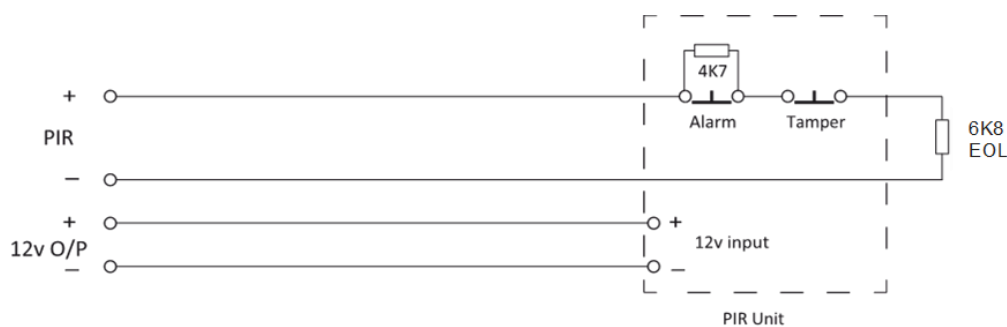

BMS 1/BMS 2 (0V IN OUT)

Building Management System control interface, using 0-10 volt proportional control signals:

- 0V – Common 0V output. This is 0 volts common reference for 0-10V input and output
- IN – Positional voltage input. Accepts 0-10 volt (DC) signal in 1 volt steps per 10% of motor time. Vent position is determined by running time, which by default is 60 seconds, i.e. 10% = 6 seconds running time, 50% = 30 seconds etc. Max input is 10VDC, with 75k Ω impedance.
- OUT – Positional voltage output. This output represents the position of the vent in 10% steps of motor run time. Provides feed-back of the 0-10V input status and vent positional information. Max output is 10VDC 2mA. Max 20K Ω load and 680R impedance.

RAIN (+ -)

Signal input from wind/rain sensors. Typically, a wind/rain sensor will have a closing contact alarm signal and may require a 24V supply. The input requires a 2K7 Ω impedance to trigger, with a 6K8 Ω 5% 0.25W EOL resistor. Monitoring current limit is 14mA, unfused. Any one of the wind/rain sensors can close a manually opened vent but will not override an alarm signal input.

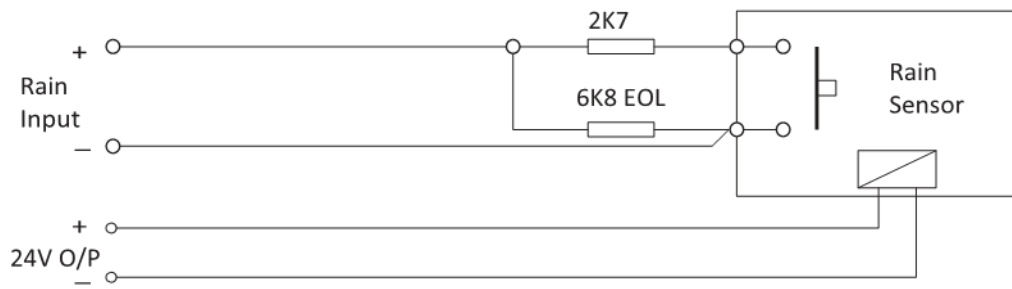
**12V (+ -)**

12VDC supply output for PIR use. Max continuous rated load 100mA, fused at 100mA resettable fuse.

Detector Circuit Conventional System Schematic

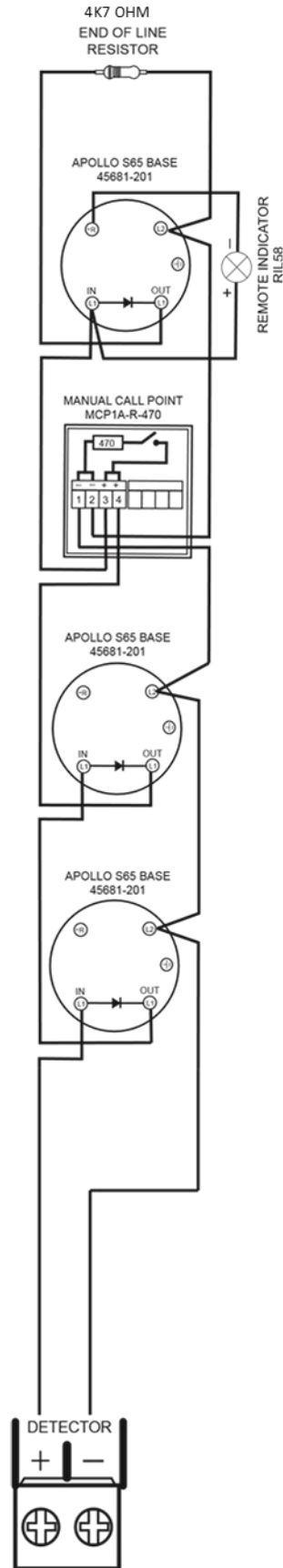

Detector Circuit Twin Wire System Schematic

Note:

Detector circuit configuration is set to 'Conventional' by default. 'Twin Wire' mode must be set using DIL switch 4 on main PCB.

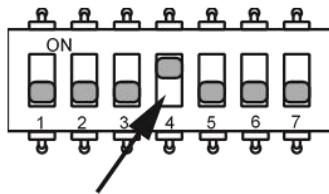

Typical Twin Wire Circuit Wiring

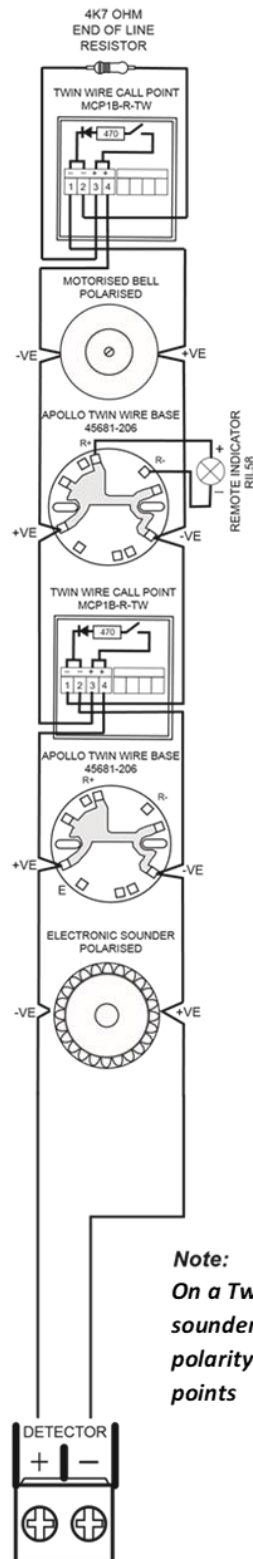

Note:
On a Twin Wire circuit the sounders are connected in reverse polarity to the detectors and call points

INSTALLATION

Safety

Suppliers of articles for use at work are required under section 6 of the Health and Safety at Work Act 1974 to ensure as reasonably as is practical that the article will be safe and without risk to health when properly used. An article is not regarded as properly used if it is used “without regard to any relevant information or advice” relating to its use made available by the supplier.

The product must be installed, commissioned and maintained for operation in accordance with the instructions and the applicable wiring codes of practice and national standard regulations for fire systems appropriate to the country and location of the installation.

This product should be installed, commissioned and maintained by, or under the supervision of, competent persons according to good engineering practice and

- i. Codes of Practice
- ii. as per local requirements.
- iii. Statutory requirements
- iv. Any instructions specifically advised by the manufacturer
- v. Maximum installation height 1.8 meter

According to the provisions of the act, you are requested to take such steps as are necessary to ensure that any appropriate information about this product is made available by you to anyone concerned with its use.

This equipment is designed to be operated from 230V AC 50/60 Hz mains supplies and is of Class I construction. As such it must be connected to a protective earthing conductor in the fixed wiring of the installation. Failure to ensure that all conductive accessible parts of this equipment are adequately bonded to the protective earth will render the equipment unsafe.



THIS IS A PIECE OF CLASS I EQUIPMENT AND MUST BE EARTHED

Only trained, suitably skilled and technically competent service personnel should undertake the Installation, Programming and Maintenance of this equipment.

6A MCB shall be used. Both poles must be disconnected prior to access the panel.

ESD Precaution

Observe precautions for handling electrostatic sensitive devices. This particularly applies to the precautions necessary to avoid Electro-Static Discharge.



This equipment is constructed with static sensitive components. Wear an anti-static earth strap connected to panel enclosure's earth point. Before installing or removing any printed circuit boards, or connecting cables, remove all sources of power (mains and battery).

Installing the System

General

Take care to avoid mounting the cabinet near high voltage cables, or areas likely to induce electrical interference. Earth links should be maintained on all system cables and grounded in the control panel. Cabling for the detection and sounder circuits is classed as extra low voltage and must be segregated away from mains voltage.

Any junction boxes used should be clearly labelled FIRE ALARM.

Any ancillary devices, e.g. door retaining magnets, must be powered from a separate power source.

Any coils or solenoids used in the system must be suppressed, to avoid damage to the control equipment.

Environment

The site chosen for the location of the panel should be clean, dry and not subject to shock or vibration. Environments where there is damp, salt air, water ingress or extremes of temperature must be avoided. The temperature should be in the range of -5°C to +40°C, and the relative humidity should not exceed 95%.

Mounting the Cabinet

Before mounting the cabinet, remove the main PCB:

- Remove power supply module wires from the PCB, taking note of where to reconnect them.
- Carefully pull main PCB from its mounting clips.

Secure the cabinet to the wall using the four indented holes in the back of the cabinet. Ensure the cabinet is mounted level and in a convenient location for it to be operated and serviced.

Recommended screws size is M 4.0 * 38mm.

External cables should pass through a suitable gland and fitted to the cabinet via preformed knockouts at the top and rear of the cabinet. Any unused knockouts must be securely blanked off. Remove any knockouts and ensure the cabinet is clear of swarf etc., prior to refitting the PCB.

Knockouts should be removed with a sharp tap at the rim of the knockout using a flat 6mm broad bladed screwdriver. Use of excessive force will damage the enclosure around the knockout.

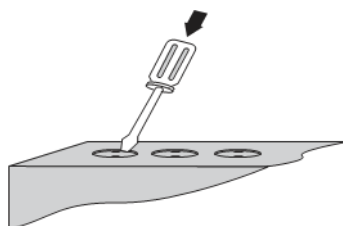

Mains Connections

Note: All connections must be carried out in accordance with local requirements and regulations.

Do not connect the mains supply to the panel until you are fully conversant with the layout and features of the equipment.

A rating plate is attached to the power supply module, describing the nature of the supply permitted.

The incoming mains supply should be brought into the panel via one of the knockouts provided.

A suitable cable gland must be used, to secure the outer sheath of the cable used. The earth must first be connected to the primary earth stud (peg) marked with a \oplus symbol, using a suitable ring crimp.

Sufficient earth lead should be left, to allow Live and Neutral connections to be accidentally pulled from the terminal block while leaving the earth connection intact.

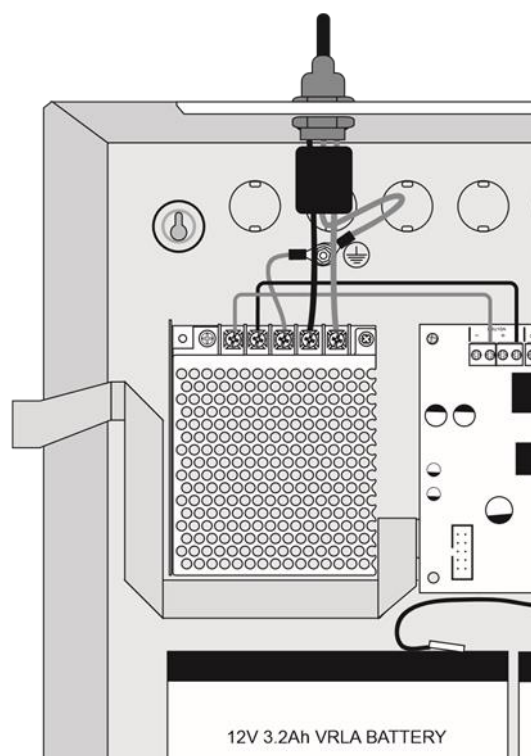

Connecting the Batteries

Batteries of even very small capacity can deliver very high currents, which can cause injuries or fire. Therefore, battery connections should be done with caution.

To optimise the service life of the batteries, the battery charger output voltage varies with temperature.

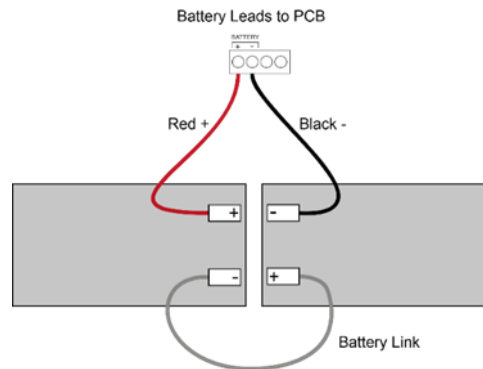

Note: In the event of mains power failure, the battery charger circuit will protect the batteries from full discharge by disconnecting them when they reach below 19v. When the mains supply is restored the batteries will be automatically reconnected.

Note: If mains power is connected before the batteries, the panel will show a Power Supply fault for up to 1 minute until the monitoring cycle has finished polling. This is normal. If the fault does not clear after 1 minute, check connections.

Battery Charging Voltage Checks

The battery charging voltage is factory calibrated to 27.3VDC +/- 0.2V at 20°C. This should not normally require adjustment. Where battery problems are experienced, the following information should be considered:

- If a battery is disconnected from the charger, no voltage will appear on the output leads or terminals, due to intelligent battery controls.
- Check the power supply voltage at the PSU 28V and 0V supply output terminals. With the batteries disconnected the voltage should be 28.0VDC +/- 0.2V at between 11°C and 40°C.
- To test the batteries, turn off the mains and see if the system will run on the batteries. Check the battery voltage, which should be 26.8V for a good battery or 22V for a flat battery.
- When the panel is re-charging a low battery, it should be possible to see the voltage across the batteries increase gradually. If this is not occurring, the batteries or the panel may be faulty.

SETUP AND PROGRAMMING

Twin Wire Mode

Note: Dependency modes are not compatible with Twin Wire mode.

Twin Wire, often referred to as sav wire, enables sounders and beacons to be connected to the same circuit as the detectors and call points.

In Twin Wire configuration, the detector circuit reverses polarity, in alarm condition, to power the sounders and beacons. The sounders and beacons need to be wired in opposite polarity to the detectors and call points (i.e., detector circuit positive wire connects to detector base and call point positive terminals but sounder and beacon negative terminals).

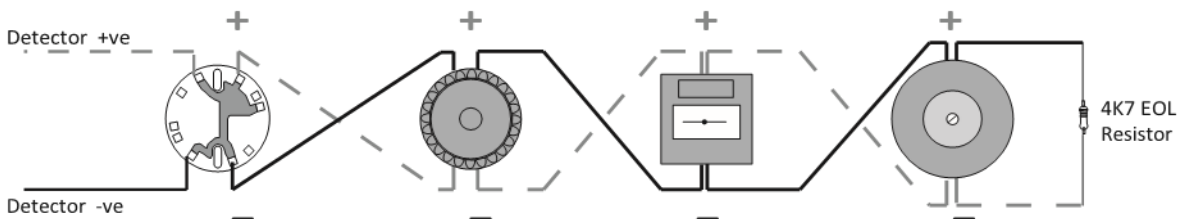

Note: Twin Wire circuits require special 'sav-wire' detector bases and polarised call points, but standard sounders. Most modern, non-addressable, low current, polarised sounders, bells and beacons are compatible, e.g., Cooper Fulleon, Besson, Klaxon, etc.

To set the DETECTOR output to Twin Wire mode, move switch 4 (TWIN MODE) on the 7-way DIL switch located on the main PCB to the 'ON' position (down).

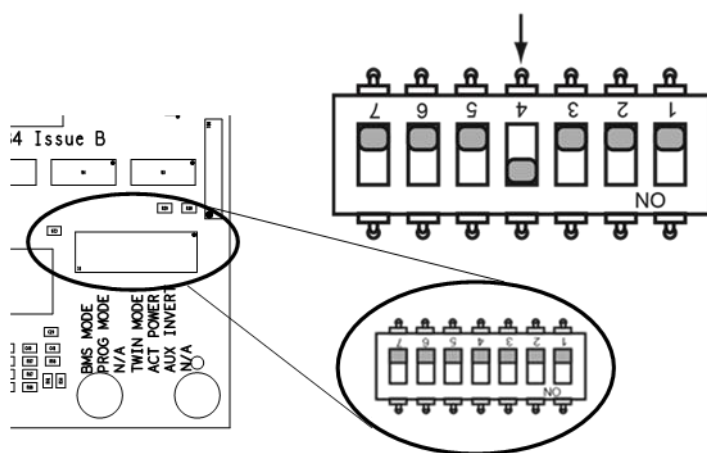

DIL Switch Options

The 7-way DIL switch located the main circuit board provides the following optional settings:

Switch 1	ACT INVERT	If set to 'ON' (down), inverts actuator (ACT) logic.
Switch 2	AUX INVERT	<p>If set to 'OFF' (up) the magnetic vent output (AUX) is normally powered 'on' (maintained). The voltage clears during an alarm condition or 'Vent Open' status and is re-instated following a reset or in 'Vent Closed' status.</p> <p>If set to 'ON' (down) the magnetic vent output (AUX) is not normally powered (non-maintained). 28V appears during an alarm condition or 'Vent Open' status. Voltage clears following a reset or 'Vent Closed' status. Could be used for controlling indicators, sounders or other ancillary equipment active in the alarm condition.</p> <p>This function is not suitable for use in BMS mode (DIL Sw7 ON) and will produce a General Fault indication on the display.</p>
Switch 3	ACT POWER	<p>If set to 'OFF' (up) the actuator outputs function normally, i.e., powered only during timed open/closing polarity reversal.</p> <p>If set to 'ON' (down) the actuator outputs are maintained (normal polarity). No reversal operation and no timed function. Output clears during alarm or 'Vent Open' conditions. Provides a higher current magnetic vent output.</p>
Switch 4	TWIN MODE	Sets DETECTOR circuit to Twin Wire operation. See previous page.
Switch 5	N/A	Not used.
Switch 6	PROG MODE	Sets panel into Level 3 Programming Mode, see below.
Switch 7	BMS MODE	Enable BMS mode (0/10v).

Level 3 Engineering Options

A series of programmable engineering options are available. These programming modes are initiated by entering a four-digit code using buttons 1 - 4 on the keypad followed by the ENTER button.

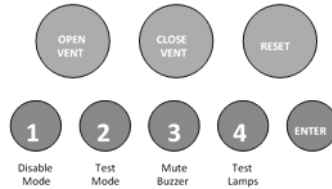

To access Level 3 options, first set switch 6 (PROG MODE) on the 7-way DIL switch located on the main PCB to the 'ON' position (down). Then activate the controls by turning the key switch or by entering the four-digit code (see Activate Controls in the OPERATING section).

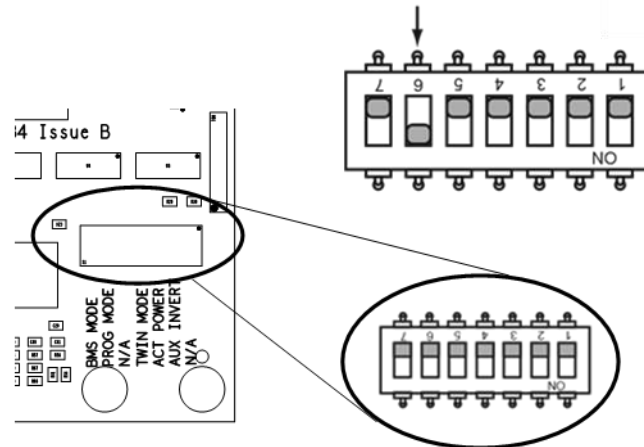

The 'Access Level' indicator will pulse rapidly to signify that Level 3 access is active.

When finished programming, press and hold button 1 for 3 seconds to exit programming mode.

Return switch 6 to the 'OFF' position (up).

Set Factory Settings

① ① ① ③ Reset All Disablements, Test Modes and Parameters back to factory settings.

Enter the required code as above and press the ENTER button.

Then press the ENTER button again and hold for 3 seconds. All disablements, test mode settings and engineering option parameters will revert to factory settings.

The panel will bleep to acknowledge the reset.

Clear All Disables

① ① ② ① Reset All Disables.

Enter the required code as above and press the ENTER button.

Then press the ENTER button again and hold for 3 seconds. Any disables will now be cleared.

The panel will beep to acknowledge the reset.

Miscellaneous Program Options

② ① ② ③ Miscellaneous Program Options

There are five miscellaneous options using code 2-1-2-3. The options are represented by the 'Vent Open', 'Vent Closed', 'Input' & 'Detector' LEDs. The options are:

1. Set motor opening time (Vent Open LED)
2. Set motor closing time (Vent Closed LED)
3. Disable actuator short circuit monitoring (Vent Open LED and Vent Closed LED)
4. Disable battery monitoring (Input LED)
5. Disable muted tone beeps (Detector LED)
6. Set keypad entry code (Input LED and Detector LED)

Enter the above code and press the ENTER button. The Vent Open LED will be on steady. Use buttons 1 & 3 to move forwards or backwards through the options as per above. With the desired LEDs lit, press the ENTER button to access edit mode for the chosen option. The LEDs will now pulse to indicate EDIT mode.

OPTION 1 (Vent Open LED) Set Motor Opening Time

Set the Actuator motor opening time for motorised vents. The time is set in 5 second steps.

The time is represented by the General Fault, General Disablement, Test Mode, Rain status, PIR Status and Power Supply Fault LEDs using a 6-bit binary code.

With the Vent Open LED pulsing, the other LEDs listed above will show the currently set time (factory default = 60 seconds). Use buttons 1 & 3 to increase or decrease the time by 5 seconds at a time. A minimum time of 10 seconds and a maximum time of 300 seconds can be set.

Press the ENTER button to set the time and return to the main menu.

OPTION 2 (Vent Closed LED) Set Motor Closing Time

Set the Actuator motor closing time for motorised vents. The time is set in 5 second steps.

The time is represented by the General Fault, General Disablement, Test Mode, Rain status, PIR Status and Power Supply Fault LEDs using a 6-bit binary code.

With the Vent Closed LED pulsing, the other LEDs listed above will show the currently set time (factory default = 60 seconds). Use buttons 1 & 3 to increase or decrease the time by 5 seconds at a time. A minimum time of 10 seconds and a maximum time of 300 seconds can be set.

Press the ENTER button to set the time and return to the main menu.

OPTION 3 (Vent Open LED and Vent Closed LED) Disable Actuator Short Circuit Monitoring

Use this option to inhibit the monitoring of the short circuit condition on the actuator output. This allows actuators that present a resistance of less than 10 Ω to be used. However, disabling the short circuit monitoring might not meet the requirements of local regulations. Connecting a resistance of less than 1 Ω might cause damage to the actuator drive circuit.

With the Vent Open LED and the Vent Closed LED pulsing, the current status is represented by the Rain Status LED:

- LED OFF = Normal, actuator short circuit is monitored.
- LED ON = Actuator short circuit is not monitored

Use button 2 to change the status. Press the ENTER button to save the setting and return to the main menu.

OPTION 4 (Input LED) Disable Battery Monitoring

Use this option to disable the battery monitoring (i.e., batteries not installed).

With the Input LED pulsing, the current status is represented by the Power Supply Fault LED:

- LED OFF = Normal, batteries are monitored
- LED ON = Battery monitoring disabled.

Use button 2 to change the status. Press the ENTER button to save the setting and return to the main menu.

OPTION 5 (Detector LED) Disable Muted Tone Beeps

Use this option to inhibit the intermittent beep that still occurs when a fault or fire tone has been muted using the Mute Buzzer button.

With the Detector LED pulsing, the current status is represented by the PIR Status LED:

- LED OFF = Normal, panel beeps intermittently when the panel buzzer has been muted
- LED ON = Muted beeps disabled.

Use button 2 to change the status. Press the ENTER button to save the setting and return to the main menu.

OPTION 6 (Input LED and Detector LED) Change / Remove Keypad Access Code

The keypad can be used to activate the panel controls instead of using the key switch. The default code is 1-2-3-4, however, this can be changed. It is also possible to disable the use of a code entry to enable controls, forcing the use of the key switch only.

With the Input LED and Detector LED pulsing, start to enter the new four key code slowly and deliberately, one number at a time, followed by ENTER.

If ENTER is pressed before the full code is entered or too many numbers are entered, the operation is aborted and the current setting remains.

The General Fault (1), General Disablement (2), Test Mode (3) & Rain Status (4) LEDs will then start to rapidly pulse in sequence to show the new code, after which time the panel will automatically drop out of the set keypad entry mode.

Note: 'Enable Controls' codes must always start with a 1 or 2.

Changing the keypad code to 1 - 1 - 1 - 1 will disable the use of a keypad to enable controls.

When finished all the miscellaneous options programming, enter the next programming code or disable the controls and return DIL switch 6 to 'OFF'.

Input Circuit Function Settings

③ ① ② ① Input Circuit Function Settings

There are 3 functional settings available for each of the input circuits (Open, Close and Detector). These are as follows:

- Alarm latching - Normally a circuit latches an alarm input signal. This setting allows the panel to clear automatically when the signal is removed. This is useful for interfacing purposes.
- Short circuit as alarm - For non-fault monitored systems. This allows a short circuit to activate an alarm rather than a fault condition.
- Detector removal monitoring (Detector circuit only) - The detector removal monitoring can be turned off. For use with detectors which are not compatible with this function.

Enter the above code and press the ENTER button.

Use button 1 and 3 to move to the circuit that requires editing:

- Open (Input LED and Vent Open LED lit),
- Close (Input LED and Vent Closed LED lit),
- Detector (Detector LED lit)

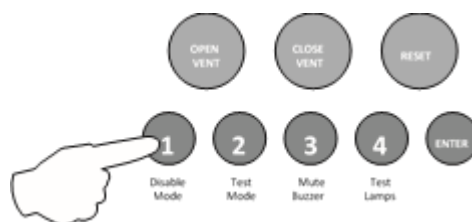

The General Alarm, General Fault & General Disablement LEDs will show the current attribute settings for that circuit (see table below).

With the required LED lit, press the ENTER button to enter 'editing mode'.

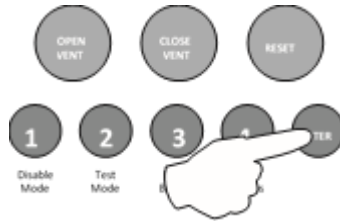

The General Alarm LED will now pulse to indicate the editing of attribute 1 (alarm latching) for the selected circuit (see table below).

Use button 1 to scroll to the attribute that requires editing, indicated by a pulsing LED as per table below.

Use button 2 to switch the attribute ON or OFF.

Then use button 1 to move to the next attribute, if required.

Press the ENTER button to return to the circuit selection, indicated by a steady circuit LED.

When all required selections have been made, press and hold key 1 for more than 4 seconds to save the settings.

3121 Input Circuit Function Settings

Attributes	Detector Input		Open Input		Close Input	
	Fast Pulse	Slow Pulse	Fast Pulse	Slow Pulse	Fast Pulse	Slow Pulse
CIRCUIT LATCH (Gen Alarm LED)	* Latching	* Non Latching	Latching	* Non Latching	Latching	* Non Latching
SHORT CIRCUIT (Gen Fault LED)	* Short cct = alarm	* Short cct = fault	Short cct = alarm	* Short cct = fault	Short cct = alarm	* Short cct = fault
DETECTOR REMOVAL (Gen Disable LED)	* Detector Removal On	* Detector Removal Off				

Default Setting indicated by *.

LED status when NOT in Edit Mode:

- Fast Pulse Status is indicated by a steady LED.
- Slow Pulse Status is indicated by an off LED.

Thermostat Controlled Ventilation Mode



Thermostat Controlled Ventilation Mode

This option allows for thermostat control of vent opening by using a thermostat to switch in a 10K resistance between the MANUAL OPEN or MANUAL CLOSE and the MANUAL COMMON terminals. This will allow the vent to open or close to a pre-defined position when the pre-set temperature on the thermostat is reached.

Enter the above code and press ENTER button.

Press button 1 or button 3 to select which of the options to change:

- Open Vent to thermostat position (Vent Open LED)
- Close Vent to thermostat position (Vent Close LED)

Press ENTER button to set the required position of the vent as indicated by the General Fault LED, Disablement LED, Test Mode LED and Rain Status LED as shown below:

Setting	General Fault	Disablement	Test Mode	Rain Status
Disabled	-	-	-	-
Close	On	-	-	-
10%	-	On	-	-
20%	On	On	-	-
30%	-	-	On	-
40%	On	-	On	-
50%	-	On	On	-
60%	On	On	On	-
70%	-	-	-	On
80%	On	-	-	On
90%	-	On	-	On
Open	On	On	-	On

Repeatedly press button 2 to cycle through the above settings.

Press ENTER to exit the edit mode and select another option.

To finish, press button 1 and hold for about 3 seconds to return to Main Display.

Type 'A' dependency mode

② ① ② ④ Type 'A' dependency mode (false alarm management)

Dependency 'A' (confirmation alarm) can be used to reduce the possibility of false alarms.

Dependency 'A' will apply the following sequence:

1. The first detector alarm is inhibited.
2. The panel resets and re-checks the inhibited detector circuit after 30 seconds.
3. If an alarm is detected, then the panel activates a full fire condition.
4. If no alarm is detected, the panel stays in an alert condition for 5 minutes. Any new alarm from the detector circuit within this time activates a full fire condition.
5. After 5 minutes or if RESET, the panel reverts to step 1.

Note: 220Ω 'Evacuate' call points should be used to provide an instant un-delayed alarm. A 470Ω call point will be included in the dependency delay sequence.

By default, Type A dependency mode is set to 'off'.

To set Detector circuit to Type 'A' dependency mode, enter the above code and press the ENTER button. The Vent Open LED will pulse rapidly to indicate the detector circuit is under selection.

The Input LED indicates the status as follows:

- **Vent Open LED Rapid Pulse** = Detector circuit is under selection.
- **Input LED Off** = Detector circuit is set to standard alarm mode.
- **Input LED On** = Detector circuit has been set to confirmation alarm mode.

Press the ENTER button to edit the selected option. Pressing the ENTER button again will toggle the status, indicated by the Input LED.

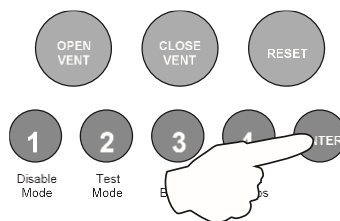

When finished programming Dependency Mode, press and hold button 1 for 3 seconds to exit programming mode.

PANEL CONTROLS & INDICATIONS

Panel Display

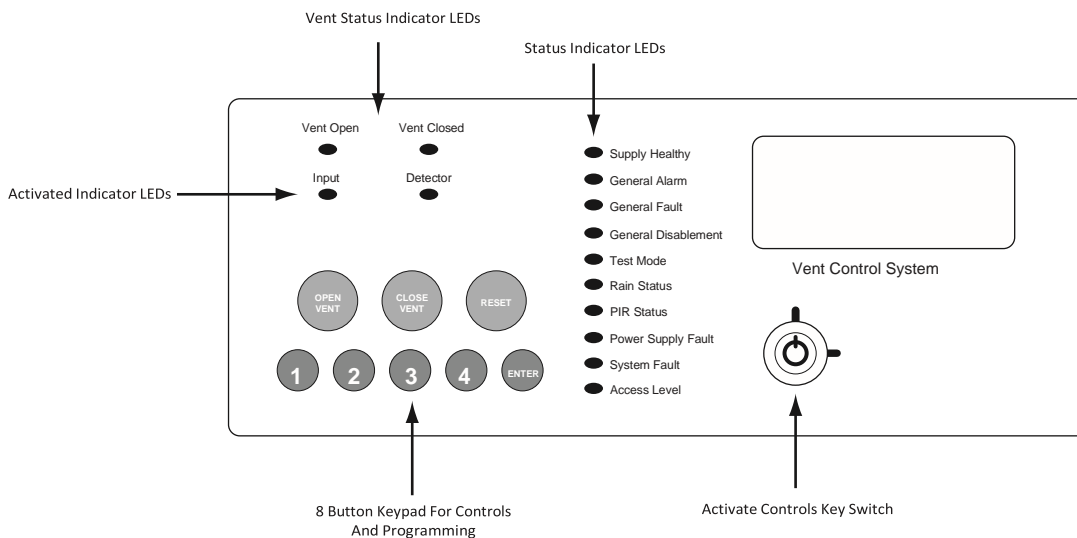

OPERATING

Activate Controls

In normal standby mode the keypad controls are inactive to protect from unauthorised operation. Controls can be activated by using the 'Activate Controls' key switch or by entering a four-digit code using the keypad.

The use of a code entry to activate the controls is enabled by default but can be disabled in the engineering functions.

To activate the controls using the key switch; turn the key clockwise to the 'On' position. The 'Access Level' indicator LED will light and all buttons on the keypad will now be operational. To deactivate the controls, turn the key back to the 'Off' position and the 'Access Level' indicator LED will extinguish.

If the key switch is in the 'On' position the keypad will remain active.

NOTE: It is not possible to remove the key in the 'On' position.

To activate the controls using the keypad; enter the four-digit code using buttons 1 - 4. The factory default code is 1-2-3-4 but can be changed in the engineering functions. After entering the four-digit code press the 'ENTER' button. The 'Access Level' indicator LED will light and all buttons on the keypad will now be operational.

After activation by code entry, controls will automatically deactivate again after 2 minutes and the panel will return to standby mode.

The test lamps and mute buzzer functions are operational without the need to activate controls.

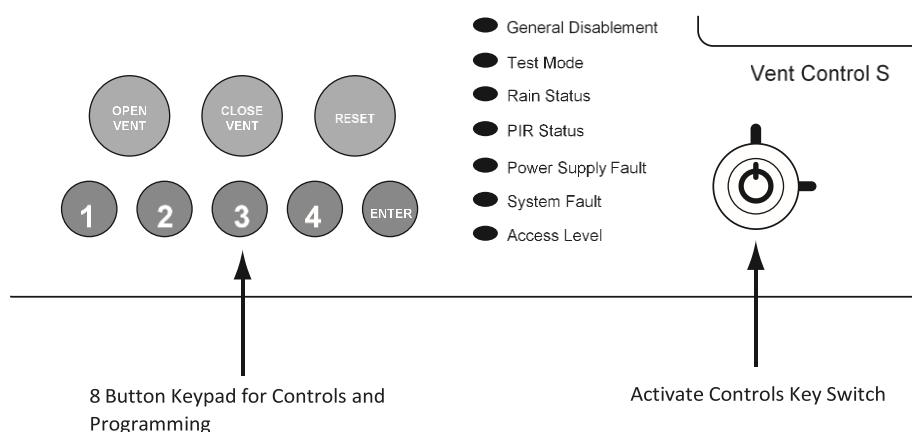

Status LED Indicators

	LED On	LED Pulsing
Vent Open	Vent in open position	Vent opening
Vent Closed	Vent in closed position	Vent closing
Vent Open/Closed + PIR	N/A	Vent closing stopped while PIR active. This requires the RESET button to be pressed to make the vent move again
Input	N/A	Input faulty or disabled
Detector	Detector circuit open circuit	Detector circuit faulty, disabled or detector removed
Supply Healthy	Power on	N/A
General Alarm	N/A	Input or Detector input alarm is active
General Fault	N/A	Indicates one or more faults are present
General Disablement	Indicates circuits are disabled	Disablement selection mode is active
Test Mode	Panel test mode is active	N/A
Rain Status	Rain input is active	Rain input is faulty or disabled
PIR Status	PIR input is active	PIR input is faulty or disabled
Power Supply Fault	Mains Input fault	Battery or Charger fault

	LED On	LED Pulsing
System Fault	Panel not functional	Panel has recovered from a system fault
Access Level	Indicates controls are activated (access level 2)	Indicates panel is in engineering mode (access level 3)

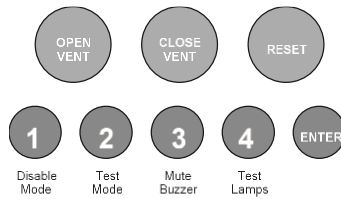

Keypad

OPEN VENT (red):	Use to activate the vent outputs to the fully open position.
CLOSE VENT (blue):	Use to activate the vent outputs to the fully closed position.
RESET (green):	Resets the panel back to standby mode.
1: (Disable Mode)	With controls active, use to disable circuits or vent outputs (see DISABLE MODE section). Also has the numeric value 1 for code entry.
2: (Test Mode)	With controls active, use to put circuits into test mode (see TEST MODE section). Also has the numeric value 2 for code entry.
3: (Mute Buzzer)	Mutes the panels internal alarm and fault buzzer. (The buzzer will still blip every 5-6 seconds during an alarm or fault condition unless disabled in the programming functions). This function is operational without the need to activate controls. Also has the numeric value 3 for code entry.
4: (Test Lamps & Buzzer)	Use this button to illuminate all LEDs and sound the internal buzzer to check that they are working correctly. This function is operational without the need to activate controls. Also has the numeric value 4 for code entry.
ENTER:	This button is used to confirm code entries.

Some buttons and indicators have other functions within the engineering facilities. These functions are described in the relevant sections.

DISABLE MODE

Disable Mode is used to disable or isolate individual circuits.

To initialise Disable Mode, firstly activate the controls by turning the key switch or by entering the four-digit code. Then press and hold the Disable Mode button (1) for 3 seconds.

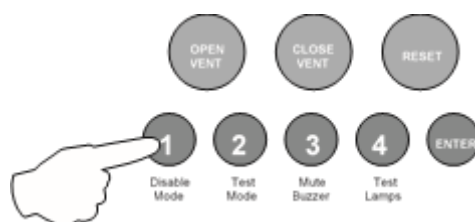

After 3 seconds the panel will bleep and the General Disablement LED and Input LED will pulse slowly, indicating that the Input circuit is in disable selection mode.

Pressing the Disable Mode button again will move the selection to the desired option:

- Vent (Input LED)
- Open (Vent Open LED)
- Close (Vent Closed LED)
- Detector (Detector LED)
- Rain (Rain Status LED)
- PIR (PIR Status LED)

When the desired circuit or output to be disabled is indicated by a slow pulsing LED, use the ENTER button to select it. Once selected the indicator LED will change to a rapid pulse. Pressing ENTER again will toggle the circuit between disabled and enabled. Then use the Disable Mode button again to move to the next circuit. Any or all circuits can be disabled simultaneously.

When all disablements have been set, press and hold the Disable Mode button for 3 seconds again. This will exit the disable selection mode and the panel will return to standby. All disabled circuits and the General Disablement will now be indicated by a steady LED.

To enable the circuits again, repeat the above process using the Disable Mode button to select the circuit and the ENTER button to remove the disablement.

TEST MODE

Test Mode is used when testing the vent control system. In test mode the devices in all circuits in test (detectors and call points, etc.), can be activated and the panel will automatically reset, enabling the system to be tested by one person.

To start Test Mode, first activate the controls by turning the key switch or by entering the four-digit code. Then press and hold the Test Mode button (2) for 3 seconds.

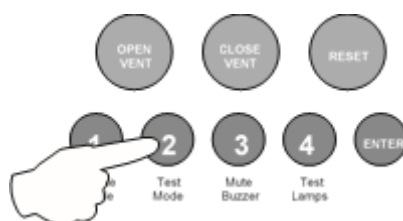

After 3 seconds the panel will bleep and the Test Mode LED will illuminate.

Pressing and holding the Test Mode button again for 3 seconds will cancel the Test Mode.

FUNCTIONALITY DURING A SYSTEM FAULT

A system fault is indicated when a processor controlling a function in the panel has a watchdog time out or processor failure. In the event of a system fault, the particular board affected may not be functional. The following indications may be observed:

- **Display Board** - System Fault LED only continuous and continuous buzzer sound. Display board is halted and no other indication or control is possible. Fault relay and fault output are activated. If a fire occurs alarm sounders and outputs will still function.
- **Main Board** - System Fault LED continuous and General Fault LED pulsing and continuous buzzer sound. Main board is halted. Fault relay is activated. No alarms may be activated on the system.
- **System Fault recovery** - System Fault LED pulsing and General Fault LED pulsing along with a pulsed buzzer (fault tone), a system fault has occurred and the affected board has recovered. The indication will remain until the panel is reset.

SERVICE & MAINTENANCE

SERVICE & MAINTENANCE The product must be maintained for operation, including periodic checks, in accordance with applicable codes of practice, national standard regulations and local instructions for fire systems appropriate to the country and location of the installation. It is the responsibility of the system user to ensure it is regularly serviced and maintained in good working order.

SCHEDULE OF TESTING

This section to be used to record ALL weekly tests of the fire alarm system

Date & Time of Test	Device Tested & Location	Comments (if any)	Initials of Tester

Date & Time of Test	Device Tested & Location	Comments (if any)	Initials of Tester

Date & Time of Test	Device Tested & Location	Comments (if any)	Initials of Tester



www.haes-tech.com