

PERIPHERALS

NETWORK COMMUNICATIONS CARD

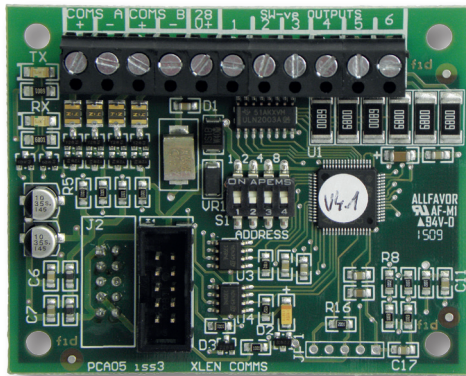

Technical Specifications

Standby Current	5.2mA
Cable Requirements	2 core 1.0mm (min) fire rated cable
Comms A - B	RS485 comms, fused @ 20mA
Supply Output	28v, fused @ 500mA
Outputs	6 x programmable switch -ve, max load = 40mA

Order Code

TPCA05	Network Comms Card
--------	--------------------

2 core cable from Comms A to Comms B

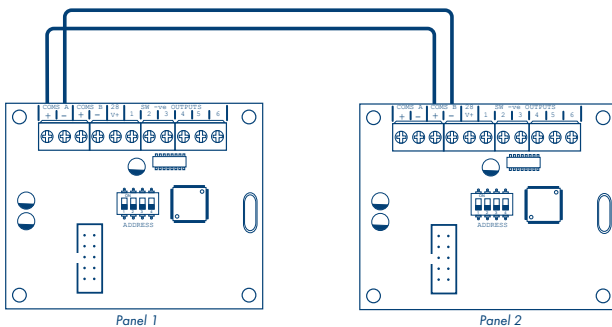

- Simple plug in communication card
- Allows networking of up to 8 control panels
- Add up to 8 repeater panels or remote display units to the network
- 2 core cable between cards
- Fully monitored fault tolerant network or legacy radial circuit wiring
- Includes 6 x programmable outputs



+44 (0) 1895 546205

Installation Instructions

The Comms PCB fits into the control panel on top of the main circuit board where the ribbon cable from the display board comms is normally plugged.

To fit the Comms PCB, power down the panel, un-plug the display board ribbon cable from the main circuit board and plug the Comms PCB into the socket instead.

A socket is provided on the top of the Comms PCB to re-connect the display board ribbon cable.

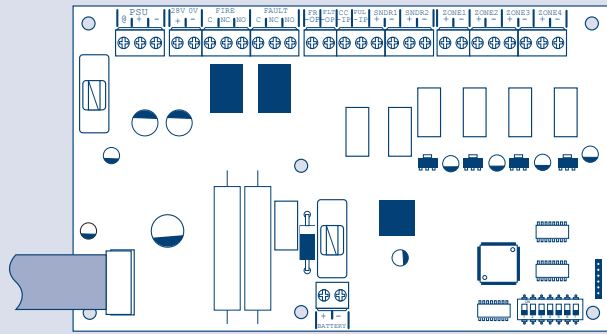

Disconnect display board ribbon cable

DIL switch

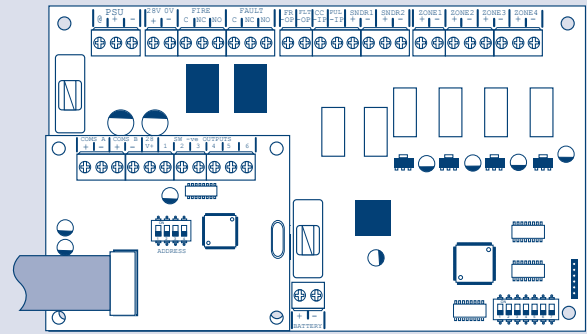

Plug Comms PCB into the socket and re-connect display board ribbon cable to socket on top of Comms PCB

Each panel to be included in the network is defined by setting a switch on the main PCB.

OFF = Stand Alone mode, ON = Network/Repeater mode.

In the case of the Esento Excel this is switch 7 on the 7 way DIL switch

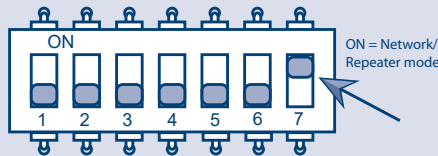

In the case of the Esento Evoque this is switch 3 on the 3 way DIL switch

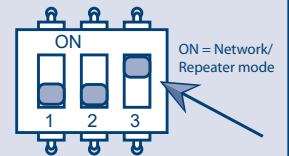

With this switch in the ON position the panel will automatically recognise & operate the Comms PCB (TPCA05).

Fault Tolerant Loop Wiring

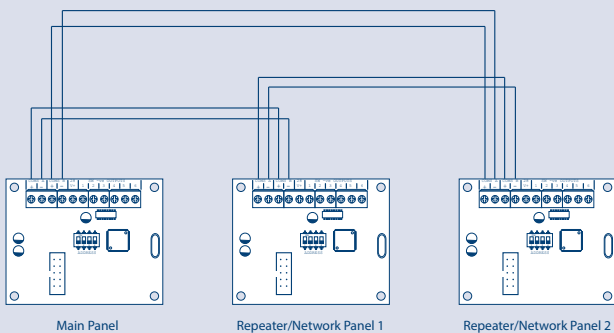

Radial/Legacy Wiring

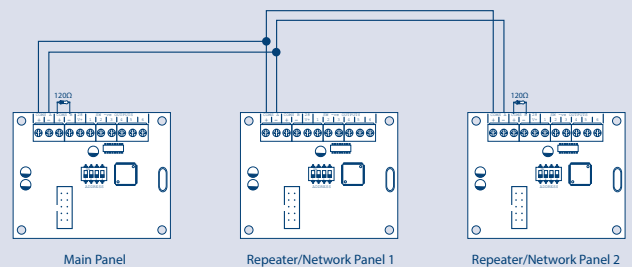

Unit 3, Horton Industrial Park, West Drayton,
UB7 8JD, United Kingdom

Tel: +44 (0) 1895 546205
Direct Sales Line: +44 (0) 1895 546205

Email: info@haes-tech.com
Web: www.haes-tech.com